

Pneumatic Valve Products
Subbase and Manifold Valve Series

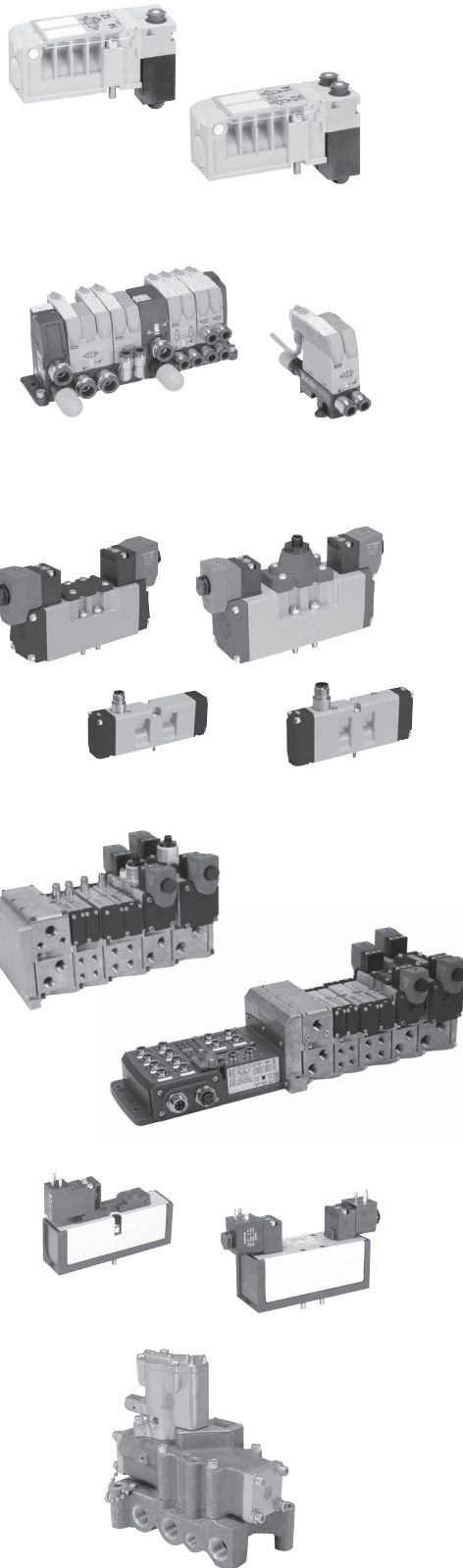

H Series Micro

Features	D2-D3
Common Part Numbers	D4-D5
Ordering Information	D6-D9
Technical / Dimensional Data	D10-D27
Accessories	D12

Moduflex Series

Features	D28-D32
Common Part Numbers / Ordering Information	D33-D45
P2M Network Nodes	D46-D55
Technical Data / Accessories	D56-D66
Dimensional Data	D67-D72

H Series ISO

Features	D73-D76
Plug-In	
15407-2 - Size 02, 01 / 5599-2, Size 1, 2	D77-D91
5599-2 - Size 3	D94-D101
Non Plug-In	
15407-1 - Size 02, 01 / 5599-1 - Size 1, 2	D102-D116
5599-1 Size 3	D117-D123
Technical Data / Accessories	D124-D138
Dimensional Data	D139-D150

Network Connectivity

Features	D151-D160
P2M Network Nodes	D161-D170
P2H Network Nodes	D171-D190
PCH Network Portal	D191-D207
Turck Network Portal	D208-D227
Accessories / Cables	D228-D230
Technical / Dimensional Data	D231

DX Series

Features	D232
Common Part Numbers / Ordering Information	D233-D239
Non Plug-In	
15407-1, Size 02 & 01	D240-D248
5599-1, Size 1, 2, 3	D249-D250
Technical Data / Accessories	D251-D263
Dimensional Data	D264-D270

Valvair II Series

Features	D271
Common Part Numbers / Ordering Information	D272-D277
Technical Data / Accessories	D278-D288
Dimensional Data	D289-D296

D

Subbase & Manifold
 Valves



Features

H Series Micro

The H Series Micro Valve System incorporates a space saving back to back valve mounting design, and achieves flow rates of 0.35 Cv per valve with 4 valves having a combined width of 42mm. This plug-in valve solution simplifies wiring with the use of 25 pin connectors or fieldbus systems.

Ports

- M7 on manifolds
- 3/8 Inch on end plates

Mounting

- Manifold

Solenoids

- 24 VDC, 1.0 watt

Certification / approval

- IP65 rated
- EMC / CE Mark: According to EN 61 000-6-2

Material specifications

Body	Polyamide reinforced fiberglass
End plates	Aluminum
Fasteners	Zinc plated steel
Manifolds	Aluminum
Spool	Brass and nitrile rubber
Spool enclosure	Brass



Operating information

Operating pressure: Vacuum to 120 PSIG (Vacuum to 8.2 bar)

Temperature range: 5°F to 120°F (-15°C to 49°C)

2-Position & Dual 3/2

0.35 Cv
C = 1.2 NI/s x bar, b = 0.13
Qn = 282 NI/min
Qmax = 510 NI/min

3-Position

0.30 Cv
C = 1 NI/s x bar, b = 0.13
Qn = 228 NI/min
Qmax = 402 NI/min

Pilot pressure requirements:

Valve number	Minimum pilot pressure	Maximum pilot pressure
HMEVX2049A	40 PSI	120 PSI
HM2VX2049A	25 PSI	120 PSI
HM5VX2049A	45 PSI	120 PSI
HMNVX2049A	40 PSI	120 PSI
HMPVX2049A	40 PSI	120 PSI
HMQVX2049A	40 PSI	120 PSI

D

Subbase & Manual Valves

H Series Micro

Modulflex Series

H Series ISO

Network Connectivity

DX ISOMAX Series

Valvair II Series

Wear Compensation System

Maximum Performance

- Low Friction
- Lower Operating Pressures
- Fast Response
- Less Wear

Long Cycle Life - Under pressure, radial expansion of the seal occurs to maintain sealing contact with the valve bore.

Non-Lube Service - No lubrication required for continuous valve shifting.

Bi-Directional Spool Seals - Common spool used for any pressure, including vacuum.

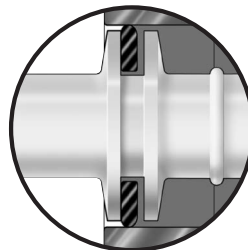

For inventory, lead times, and kit lookup, visit www.pdnplu.com

Features

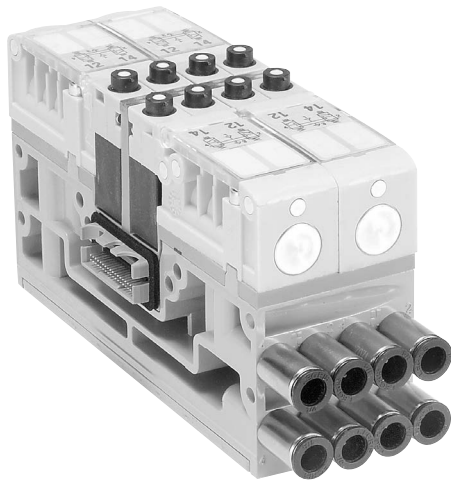
**Innovative Product Design**

- Back to back valve mounting design centralizes wiring in the manifold
- 4 valves on a 42mm wide manifold provides a 10.5mm wide valve solution with a reduced cost
- High flow of 0.35 Cv allows for broad application use
- Plug-in valve electronics reduce and eliminate wiring system costs
- Multiple pressure zones for many applications on the same manifold

Standard Features

- Integrated LED's identify when solenoids are active
- Side and bottom porting options on manifolds and end plates for versatile mounting
- All valve functions available for complete product offering
- Valves can be arranged in any combination for maximum flexibility
- Internal and external pilot options available for vacuum to 145 PSI applications
- IP65 protection enables direct machine mounting
- Product identification, valve function, and port description tags are standard on every manifold and are clearly visible thru a protective cover
- User configurable overrides for non-locking, locking, or no override options

Manifold Platforms

- 25 pin D-sub manifolds for control systems with discrete Outputs
- IO-Link Type A & Type B communication modules
- Cost effective moduflex fieldbus manifolds for control systems with DeviceNet™, Profibus®, Interbus and CANopen fieldbus and no inputs or outputs near valves
- Cost effective moduflex fieldbus manifolds with AS-i communication offer both Inputs and solenoid control
- Fully functional H Series fieldbus manifolds for control systems with inputs and outputs attached to the valve manifold
- Enhanced H Series bus expansion allows 4 H Series fieldbus valve manifolds to be connected to a single communication module significantly reducing costs on large machines
- Rockwell Automation RS Logix 5000™ users can take Advantage of Preferred Connectivity, by using the preloaded device profiles

Complete Assemblies

- All products offered as component level parts for individual assembly
- Simple manifolds offer sub-assembly level products with valves and fittings attached to manifold bases in a single part number
- Add-a-fold systems offer complete assemblies; including valves, manifolds, end plates, fittings, and mufflers in as few as 2 part numbers

D







Subbase & Manual
ValvesH Series
MicroModuflex
SeriesH Series
ISONetwork
ConnectivityDX ISOMAX
SeriesValvair II
Series

For inventory, lead times, and kit lookup, visit www.pdnplu.com

D3

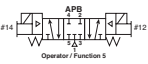
Parker Hannifin Corporation
Pneumatic Division
Richland, Michigan
www.parker.com/pneumatics

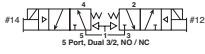
H Series Micro Valves

	Symbol	Type	Cv	Operator	Part Number
		4-way, 2-position	0.35	Single solenoid	HMEVX2049A
		4-way, 2-position	0.35	Double solenoid	HM2VX2049A
		4-way, 3-position, all ports blocked	0.3	Double solenoid	HM5VX2049A
		3-way, 2-position, dual valve, NC/NC	0.35	Double solenoid	HMNVX2049A
		3-way, 2-position, dual valve, NO/NO	0.35	Double solenoid	HMPVX2049A
		3-way, 2-position, dual valve, NO/NC	0.35	Double solenoid	HMQVX2049A
		Blanking plate	N/A	N/A	HMBVX00XXA
		Intermediate air supply	N/A	N/A	HMCVX00XXA

- All valves, except double solenoid 2-position, ship with multi functional overrides. Standard valve configuration is non-locking manual override. Each solenoid can be configured for locking override or no override with the included manual override caps.
- All valve options include an LED, which is built into the manifold.
- All valve options pull pilot pressure from the manifold. The manifold assembly can be configured for internal or external pilot on the end plate.

Manifold Bases

	Part Numbers				
Plug-In Valve Manifolds					
Single solenoid outputs only	<table border="1"> <tr> <th>Side Port</th> <th>Bottom Port</th> </tr> <tr> <td>PSM21JAP</td> <td>PSM22JAP</td> </tr> </table>	Side Port	Bottom Port	PSM21JAP	PSM22JAP
Side Port	Bottom Port				
PSM21JAP	PSM22JAP				
Double or single solenoid outputs	<table border="1"> <tr> <th>Side Port</th> <th>Bottom Port</th> </tr> <tr> <td>PSM21MAP</td> <td>PSM22MAP</td> </tr> </table>	Side Port	Bottom Port	PSM21MAP	PSM22MAP
Side Port	Bottom Port				
PSM21MAP	PSM22MAP				

Each manifold holds 4 H Series Micro Valves. Double address circuit boards contain outputs for 8 solenoids, and can be used with any valve. When a single solenoid valve is used, one address is not used but is still present on the manifold. Single address circuit boards contain outputs for 4 solenoids. Only single solenoid valves can be used.

 Most popular.









D
Subbase & Manual Valves
H Series Micro
Modulflex Series
H Series ISO
Network Connectivity
DX ISOMAX Series
Valvair II Series



For inventory, lead times, and kit lookup, visit www.pdnplu.com

Common Part Numbers

Internal Pilot End Plate Kits

	Electrical Option	Porting	Side Port	Bottom Port
	25-pin, D-sub	NPT	PSML25AP	PSML26AP
		BSPP	PSML21AP	PSML22AP
	Turck fieldbus with valve driver module - 16 outputs	NPT	PSMT15AP	PSMT16AP
		BSPP	PSMT11AP	PSMT12AP
	Turck fieldbus with valve driver module - 32 outputs	NPT	PSMT25AP	PSMT26AP
		BSPP	PSMT21AP	PSMT22AP
	Moduflex up to 24 outputs	NPT	PSMM45AP	PSMM46AP
		BSPP	PSMM41AP	PSMM42AP
	H Series Fieldbus with valve driver module	NPT	PSML65AP	PSML66AP
		BSPP	PSML61AP	PSML62AP
	H Series Fieldbus with valve driver module and bus extension connector	NPT	PSMM55AP	PSMM56AP
		BSPP	PSMM51AP	PSMM52AP
	H Series Fieldbus with valve driver module and 24VDC connector	NPT	PSMM65AP	PSMM66AP
		BSPP	PSMM61AP	PSMM62AP
	H Series Fieldbus with valve driver module, bus extension connector and 24VDC connector	NPT	PSMM75AP	PSMM76AP
		BSPP	PSMM71AP	PSMM72AP

 Most popular.



For inventory, lead times, and kit lookup, visit www.pdnplu.com

Simple Manifold Assemblies

Includes a valve manifold with 4 valves and fittings installed.
 End Plates must be ordered separately.

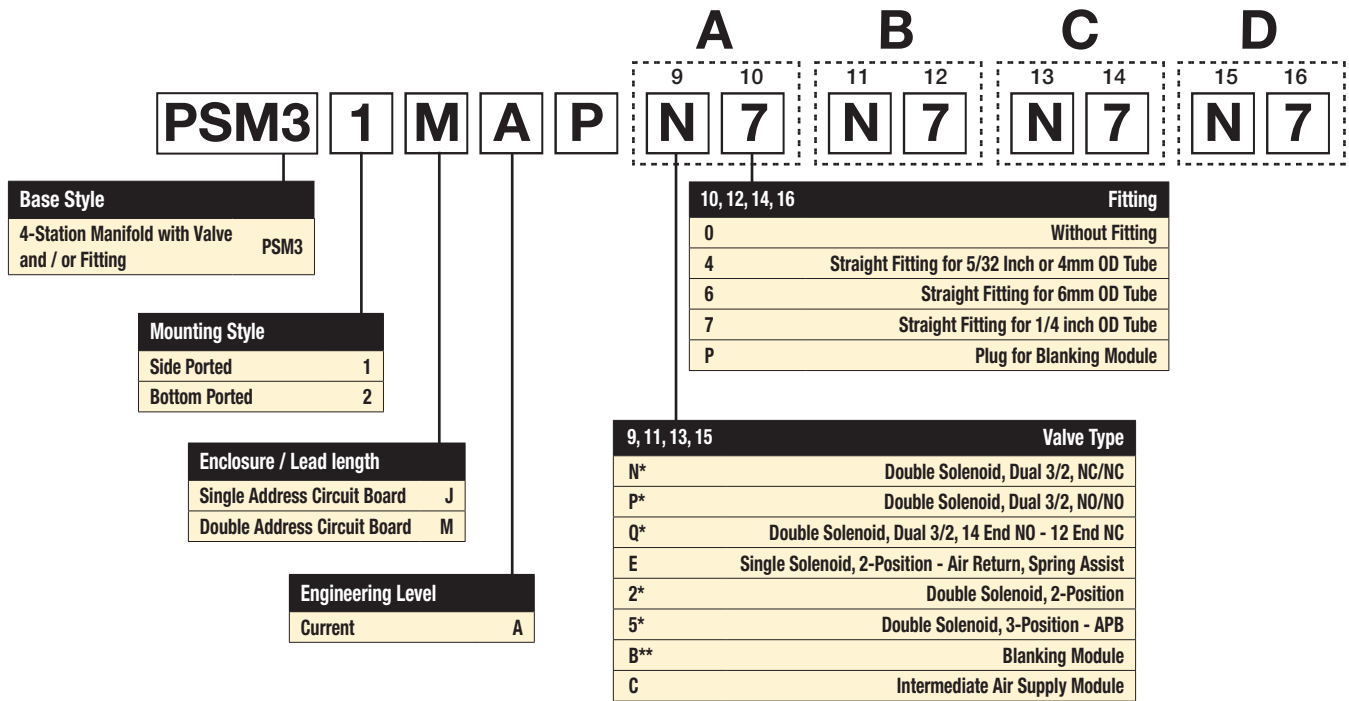

* Requires double address circuit board, enclosure "M".
 ** Requires fitting "P".

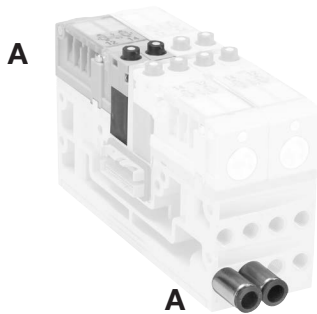

Valve Position A - Character 9
Fitting Position A - Character 10

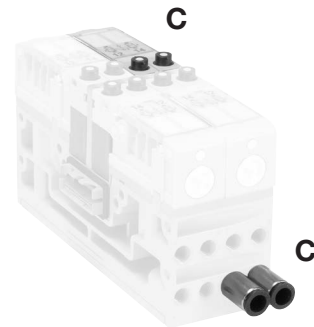

Valve Position C - Character 13
Fitting Position C - Character 14

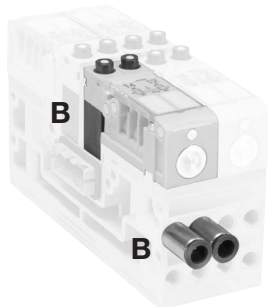

Valve Position B - Character 11
Fitting Position B - Character 12

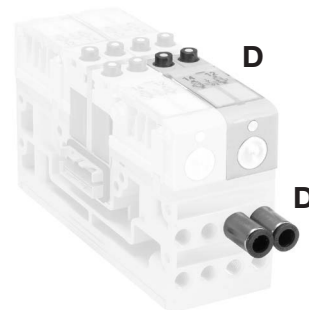

Valve Position D - Character 15
Fitting Position D - Character 16

Most popular.



For inventory, lead times, and kit lookup, visit www.pdnplu.com

Plug-in End Plate Kits

BOLD OPTIONS ARE MOST POPULAR.

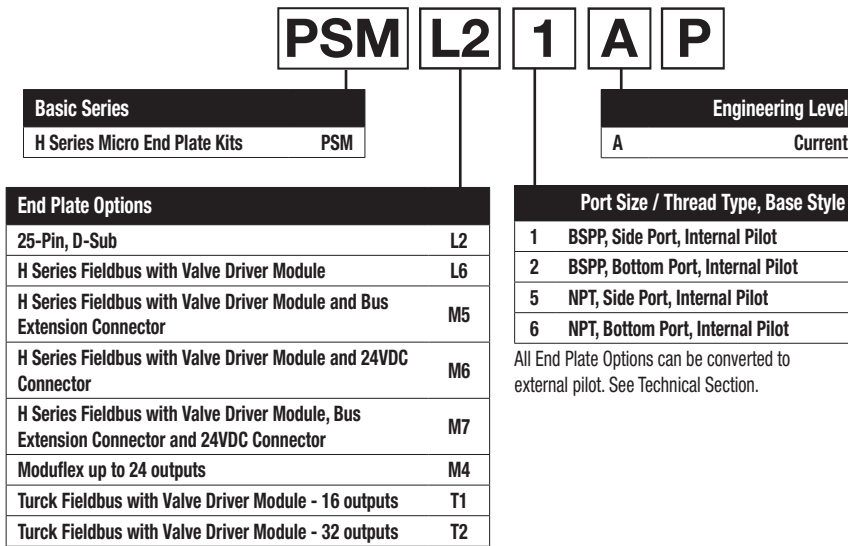

All End Plate Options can be converted to external pilot. See Technical Section.

Turck, H Series Fieldbus, and Moduflex communication modules must be ordered separately. See Fieldbus Section for more information.



L2: 25-Pin, D-Sub End Plates



L6: H Series Fieldbus End Plates



M4: Moduflex Fieldbus End Plates



M5: H Series Fieldbus with Bus Extension End Plates



M6: H Series Fieldbus with 24VDC Connector End Plates



M7: H Series Fieldbus with Bus Extension & 24VDC Connector End Plates

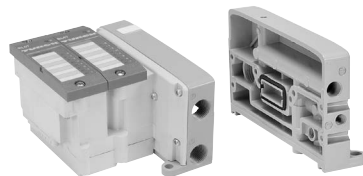

T1, T2: H Series Micro Turck End Plates

Valve power supply connector
 (As seen on module)

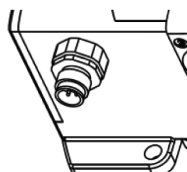

M12 Male (A coding)

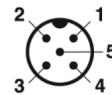

Pin 1 - 24 VDC valve
 Pin 2 - Not connected
 Pin 3 - 0 VDC valve
 Pin 4 - Not connected
 Pin 5 - Protective Earth (PE)

Local bus connector
 (As seen on module)

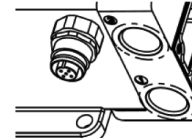

M12 Female (A coding)

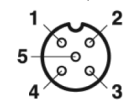

Pin 1 - CAN SHLD
 Pin 2 - CAN V+ (24 VDC)
 Pin 3 - CAN GND
 Pin 4 - CAN H
 Pin 5 - CAN L



For inventory, lead times, and kit lookup, visit www.pdnplu.com

Ordering Information

How To Order Plug-in Add-A-Fold Assemblies

1. List Add-A-Fold Assembly call out. This automatically includes the end plate kit assembly.
2. List Simple Manifold Assemblies. List left to right, LOOKING AT THE CYLINDER PORTS on the manifold.

Maximum Number of Solenoids
(Maximum Energized Simultaneously)

24VDC	25-pin D-sub	Moduflex	H Series Fieldbus*	Turck	
				16 Outputs	32 Outputs
	24 (24)	24 (24)	32 (32)	16 (16)	32 (32)

* Maximum of 32 solenoids per manifold. With Bus Extension functionality, 4 manifolds with up to 32 solenoids each can be connected on the same network.

Add-A-Fold Assembly Model Number

AAHM D 3 24 0 0 0 0

Valve Series	
H Series Micro Add-A-Fold	AAHM

End Plate Option	
Turck Fieldbus with Valve Driver Module - 16 Outputs	A
Turck Fieldbus with Valve Driver Module - 32 Outputs	B
25-Pin, D-Sub - 24 Outputs	D
H Series Fieldbus with Valve Drive Module - 32 Outputs	Y
H Series Fieldbus with Valve Drive Module and Bus Extension Connector - 32 Outputs	W
H Series Fieldbus with Valve Drive Module and 24VDC Connector - 32 Outputs	X
H Series Fieldbus with Valve Drive Module and Bus Extension and 24VDC Connector - 32 Outputs	Z
Moduflex - Up to 24 Outputs	T

H Series Fieldbus and Moduflex communication modules must be ordered separately.

End Plate Type		
BSPP Threads	Bspp Side Port, Internal Pilot	1
	Bspp Bottom Port, Internal Pilot	2
	Bspp Side Port, External Pilot	3
	Bspp Bottom Port, External Pilot	4
NPT Threads	Npt Side Port, Internal Pilot	5
	Npt Bottom Port, Internal Pilot	6
	Npt Side Port, External Pilot	7
	Npt Bottom Port, External Pilot	8

Number of Stations*	
4 Valve Manifold	04
8 Valve Manifold	08
12 Valve Manifold	12
16 Valve Manifold	16
20 Valve Manifold	20
24 Valve Manifold	24
28 Valve Manifold	28
32 Valve Manifold	32

* For an Add-A-Fold part number to be valid, all segments must have a corresponding electrical connection at the end plate. See Maximum Number of Solenoids chart.

Pilot Exhaust on End Plate		
0	Without Fitting	
M	Muffler	
4	Straight Fitting for 4mm OD Tube	BSPP Threads
6	Straight Fitting for 6mm OD Tube	
4	Straight Fitting for 5/32 inch OD Tube	NPT Threads
7	Straight Fitting for 1/4 inch OD Tube	

M7 Pilot Port on End Plate		
<i>Internal Pilot End Plate</i>		
0	With Standard Plug	
<i>External Pilot End Plate</i>		
0	Without Fitting	
4	Straight Fitting for 4mm OD Tube	BSPP Threads
6	Straight Fitting for 6mm OD Tube	
4	Straight Fitting for 5/32 inch OD Tube	NPT Threads
7	Straight Fitting for 1/4 inch OD Tube	

3/8" Exhaust on End Plate		
0	Without Fitting	
M	Muffler	
8	Straight Fitting for 8mm OD Tube	BSPP Threads
A	Straight Fitting for 10mm OD Tube	
7	Straight Fitting for 1/4 inch OD Tube	NPT Threads
9	Straight Fitting for 3/8 inch OD Tube	

3/8" Inlet Port on End Plate		
0	Without Fitting	
8	Straight Fitting for 8mm OD Tube	BSPP Threads
A	Straight Fitting for 10mm OD Tube	
7	Straight Fitting for 1/4 inch OD Tube	NPT Threads
9	Straight Fitting for 3/8 inch OD Tube	

Note:
BSPP fittings can only be used with BSPP Manifolds.
NPT fittings can only be used with NPT Manifolds.

 Most popular.



For inventory, lead times, and kit lookup, visit www.pdnplu.com

D
Subbase & Manual Valves
H Series Micro
Moduflex Series
H Series ISO
Network Connectivity
DX ISOMAX Series
Valvair II Series

25-pin, D-Sub Manifolds

24 Single Solenoid Valves

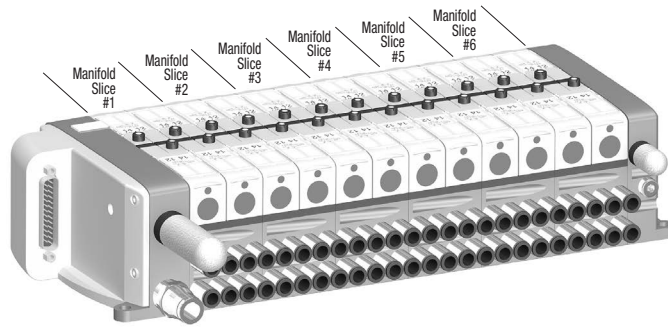

Add-A-Fold

Manifold is factory assembled and tested for pneumatic leaks and electrical continuity.

Item	Qty	Description	Part Number
01	1	24 valve Add-A-Fold with end plates	AAHMD5249M0M
02	6	4 valve simple manifold slices #1-6	PSM31JAPE7E7E7E7

Component Level

Item	Qty	Description	Part Number
01	1	25-pin, D-sub, end plate	PSML25AP
02	24	Single solenoid valve	HMEVX2049A
03	6	Manifold, side ported, single address	PSM21JAP
04	50	1/4" Tube fittings (in box quantity)	PS567925
05	10	3/8" Tube fittings (in box quantity)	PS568338
06	1	3/8" Exhaust muffler	P6M-PAB3
07	1	1/8" Exhaust muffler	P6M-PAB1

Sandwich Regulator

Description	Kit Number
 Common port regulator, 5 to 125 PSI with gauge	PSMRAX6AP

Notes: Cv values are reduced when using a sandwich regulator to 0.20 for 2-position and Dual 3/2 valves, and 0.17 for 3-position APB valves. The sandwich regulator passes full pilot pressure from the manifold, allowing the regulated pressure to adjusted down to 5 PSI without affecting valve functionality.



Flow Controls

Description	Kit Number
 4mm to 4mm or 5/32" to 5/32" OD tube	FC832-5/32
1/4" to 1/4" O.D. tube	FC832-4

 Most popular.

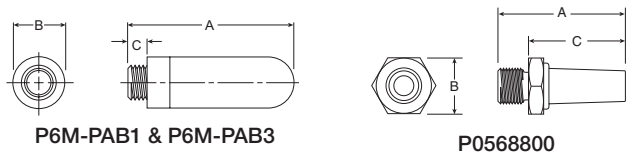
Mufflers





	Port Thread	A	Ø B	C	Weight (grams)	Part Number
	1/8 pilot exhaust – BSPP or NPT	1.14 (29)	0.55 (14)	0.24 (6)	0.02	P6M-PAB1
	3/8 main exhaust – BSPP or NPT	2.36 (60)	0.98 (25)	0.35 (9)	0.06	P6M-PAB3
	M7 x 1 bottom port pilot exhaust *	0.98 (25)	0.43 (11)	0.75 (19)	5	P0568800

Note: Recommended tube durometer of 95 or higher. A tube support may be required if tube durometer is less than 95.

* Must be order in multiples of 10.

Fittings – Must be ordered in multiples of 10

	Thread	Tube O.D.	Part Number
Manifold or pilot supply ports – straight			
	M7	4mm or 5/32"	PS567904
	M7	6mm	PS567906
	M7	1/4"	PS567925
Main inlet or exhaust ports			
	3/8" NPT	1/4"	PS568325
	3/8" NPT	3/8"	PS568338
	3/8" BSPP	8mm	PS568308
	3/8" BSPP	10mm	PS568310
Pilot exhaust ports			
	1/8" NPT	5/32"	PS568215
	1/8" NPT	1/4"	PS568225
	1/8" BSPP	4mm	PS568204
	1/8" BSPP	6mm	PS568206



For inventory, lead times, and kit lookup, visit www.pdnplu.com

Moduflex Fieldbus Manifold

**4 Double Solenoid Valves,
 8 Single Solenoid Valves**

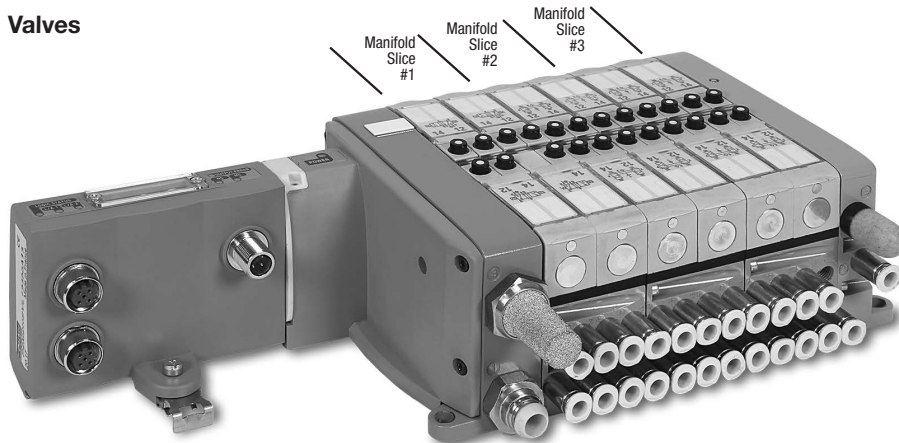

Add-A-Fold

Manifold is factory assembled and tested for pneumatic leaks and electrical continuity. P2M IO-Link Module ordered separately.

Item	Qty	Description	Part Number
01	1	12 valve add-a-fold with end plates	AAHMT5129M0M
02	1	4 valve simple manifold slice #1	PSM31MAPN7N7N7
03	2	4 valve simple manifold slice #2-3	PSM31JAPE7E7E7E7

Component Level

Item	Qty	Description	Part Number
01	1	Moduflex fieldbus, end plate	PSMM45AP
02	4	Double solenoid, dual 3/2, NC/NC	HMN VX2049A
03	1	Manifold, side ported, double address	PSM21MAP
04	8	Single solenoid valve	HMEVX2049A
05	2	Manifold, side ported, single address	PSM21JAP
06	30	1/4" tube fittings (in box quantity)	PS567925
05	10	3/8" tube fittings (in box quantity)	PS568338
06	1	3/8" exhaust muffler	P6M-PAB3
07	1	1/8" exhaust muffler	P6M-PAB1

Additional Components

**Moduflex Communication Modules
 Industrial Ethernet – IP65**

Industrial Ethernet Protocol	Maximum Addresses †	Part Number
EtherNet/IP (<i>Safe Power Capable</i>)	24 †	P2M2HBVE12400
PROFINET (<i>Safe Power Capable</i>)	24 †	P2M2HBVN12400
EtherCAT (<i>Safe Power Capable</i>)	24 †	P2M2HBVT12400
Modbus/TCP (<i>Safe Power Capable</i>)	24 †	P2M2HBVM12400
PowerLink (<i>Safe Power Capable</i>)	24 †	P2M2HBVW12400

Industrial Ethernet – IP20

Industrial Ethernet Protocol	Maximum Addresses †	Part Number
Profinet IO	24 †	P2M2HBVE12400RJ
EtherNet/IP	24 †	P2M2HBVN12400RJ
EtherCAT	24 †	P2M2HBVT12400RJ

† 24 addresses capable when used with H Micro and H ISO only

Most popular.

IO-Link

IO-Link - 24 outputs	Part Number
Class A 3-Pin, Aux power 1 & 3	P2M2HBVL12400A13
3-Pin, Aux power 4 & 3	P2M2HBVL12400A43
3-Pin, Aux power 4 & 2	P2M2HBVL12400A42
Class B 5-Pin, Aux power 2 & 5	P2M2HBVL12400B25

Note: For Safe Power Capable version, add “-SPC” to end of part number

IO-Link

Bus Protocol	Connector Type	Part Number
Power & Communication Cable	5-pin male to female cable, TPE	RKC 4.5T*-RSC 4.5T/S1587

Where * = 1, 2, 3, 4, 5, 10, 20 meter standard lengths

D

Subbase & Manual Valves

H Series Micro

Moduflex Series

H Series ISO

Network Connectivity

DX ISOMAX Series

Valvair II Series



For inventory, lead times, and kit lookup, visit www.pdnplu.com

H Series Fieldbus Manifold

12 Double Solenoid Valves, 8 Single Solenoid Valves

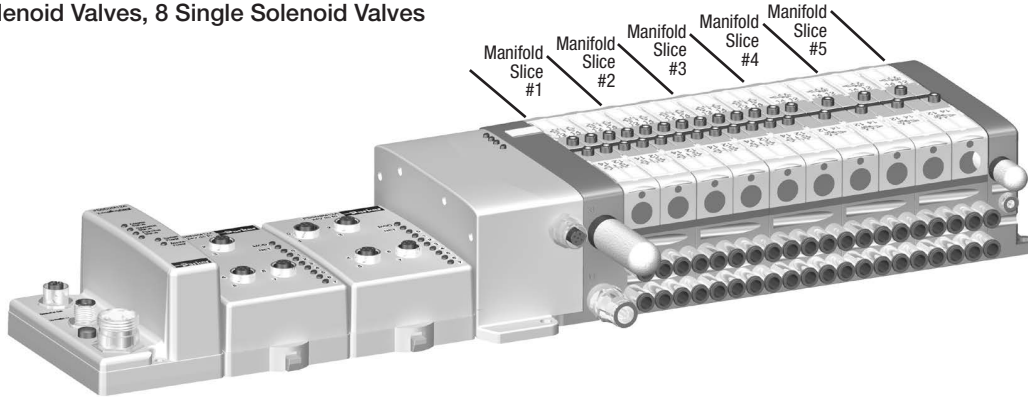

Add-A-Fold

Manifold is factory assembled and tested for pneumatic leaks and electrical continuity.

Item	Qty	Description	Part Number
01	1	20 valve add-a-fold with end plates	AAHMW5209M0M
02	3	4 valve simple manifold slices #1-3	PSM31MAPN7N7N7N7
03	2	4 valve simple manifold slices #4-5	PSM31JAPE7E7E7E7

Component Level

Item	Qty	Description	Part Number
01	1	H Series Fieldbus, with valve driver module and bus extension connector	PSMM55AP
02	12	Double solenoid, dual 3/2, NC/NC	HMNVX2049A
03	3	Manifold, side ported, double address	PSM21MAP
04	8	Single solenoid, 2-position, air return, spring assist	HMEVX2049A
05	2	Manifold, side ported, single address	PSM21JAP
06	40	1/4" tube fittings (in box quantity)	PS567925
07	10	3/8" tube fittings (in box quantity)	PS568338
08	1	3/8" exhaust muffler	P6M-PAB3
09	1	1/8" exhaust muffler	P6M-PAB1

12 Double Solenoid Valves, 8 Single Solenoid Valves

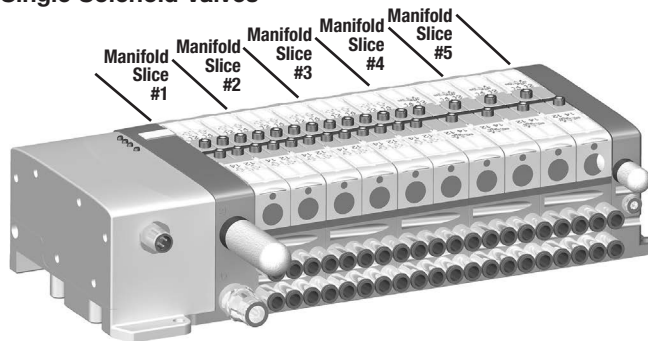

Add-A-Fold

Manifold is factory assembled and tested for pneumatic leaks and electrical continuity.

Item	Qty	Description	Part Number
01	1	20 valve add-a-fold with end plates	AAHMX5209M0M
02	3	4 valve simple manifold slices #1-3	PSM31MAPN7N7N7N7
03	2	4 valve simple manifold slices #4-5	PSM31JAPE7E7E7E7

Additional Components

Description	Part Number
H Series Fieldbus Devicenet Communication	PSSCDM12A
8 Digital Input, 24VDC, M12 Connectors	PSSN8M12A
H Series Micro Bus Extender Cable	PSSVEXT1

See H Series Fieldbus section of catalog for more information.

 Most popular.





Component Level

Item	Qty	Description	Part Number
01	1	H series fieldbus, with valve driver Module and 24VDC connector	PSMM65AP
02	12	Double solenoid, dual 3/2, NC/NC	HMNVX2049A
03	3	Manifold, side ported, double address	PSM21MAP
04	8	Single solenoid, 2-position, air return, spring assist	HMEVX2049A
05	2	Manifold, side ported, single address	PSM21JAP
06	40	1/4" tube fittings (in box quantity)	PS567925
07	10	3/8" tube fittings (in box quantity)	PS568338
08	1	3/8" exhaust muffler	P6M-PAB3
09	1	1/8" exhaust muffler	P6M-PAB1



For inventory, lead times, and kit lookup, visit www.pdnplu.com

Manifold to Manifold Gaskets*

	Description	Part Number
	All galleys passing	PSM0001
	Main pressure to rear or front valves blocked, exhaust passing	PSM0002
	Main pressure to rear or front valves blocked, exhaust blocked	PSM0003
	All galleys blocked	PSM0004

* Includes 1 Gasket

Solenoid Kit

Description	Part Number
 24VDC solenoid kit with screws	PSM0010

Blanking Plate Kits

Description	Part Number
 Blanking plugs, gasket, and mounting screws.	HMBVX00XXA

Blanking plugs must be inserted into the 2 and 4 ports of the manifold corresponding to the blanking plate.

Intermediate Air Supply Base

Description	Part Number
 Gasket and mounting screws.	HMCVX00XXA

Fittings (not included) must be inserted into the 2 and 4 ports of the manifold corresponding to the intermediate air supply. Auxiliary pressure should be supplied through these fittings, which will directly feed the #1 pressure galley.

Override Caps

Description	Part Number
 Set of 10 manual override caps	PSM0011

Gaskets and Valve Screws

Description	Part Number
 Set of 5 valve to manifold gaskets and 10 screws	PSM0012

Regulator Gauge

Description	Part Number
 5 to 125 PSI gauge	P0566202

Plugs

Description	Part Number
 Set of 10 M7 plugs (Part No. PS567900) for auxiliary and pilot pressure ports	PSM0013

Screws

Description	Part Number
 Set of 10 manifold to manifold M3 screws	PSM0014

Valve Labels*

Description	Part Number
Single solenoid diagram	PSM002E
Double solenoid diagram	PSM0022
Double solenoid diagram – APB	PSM0025
Double solenoid diagram – Dual 3/2 NC/NC	PSM002N
Double solenoid diagram – Dual 3/2 NO/NO	PSM002P
Double solenoid diagram – Dual 3/2, 14 end NO, 12 end NC	PSM002Q

*Includes 10 Labels.

Protective Cover

Description	Part Number
 Protective polyester cover Set of 10	PS5706

25-Pin, D-Sub Cable (Female)

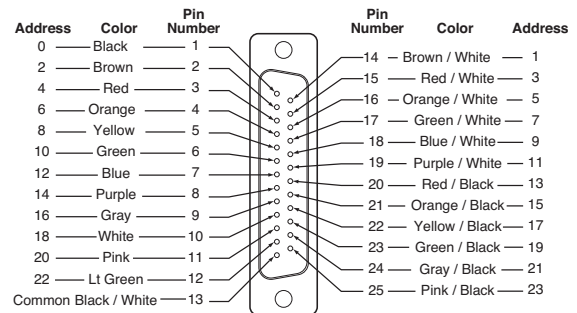

Description	Length	Part Number
 25-pin, D-sub cable, IP20	3 meters	P8LMH25M3A
25-pin, D-sub cable, IP20	9 meters	SCD259D
25-pin, D-sub cable, IP65	3 meters	SCD253W
25-pin, D-sub cable, IP65	9 meters	SCD259WE

D

Subbase & Manual Valves

H Series Micro

Modulflex Series

H Series ISO

Network Connectivity

DX ISOMAX Series

Valvair-II Series



For inventory, lead times, and kit lookup, visit www.pdnplu.com

Pilot Configuration

Side Ported

Manifolds can be configured for either internal or external pilot in the field. Side ported manifolds are configured for internal pilot when the M7 plug is located in the Px port on the front of the right hand end plate. Moving this plug to the internal pilot port of the right hand end plate and replacing it with a fitting allows an external pilot to be used.

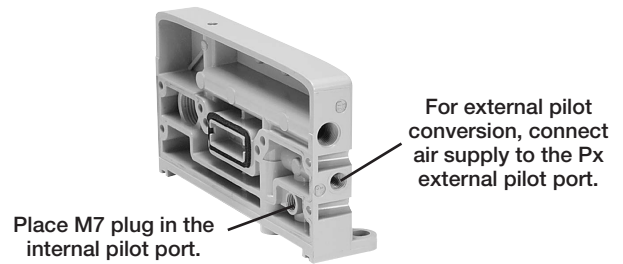

Bottom Ported

Bottom ported manifolds are configured for internal pilot when the M7 plug is located in the Px port on the bottom of the right hand end plate. Moving this plug to the internal pilot port of the right hand end plate and replacing it with a fitting allows an external pilot to be used.

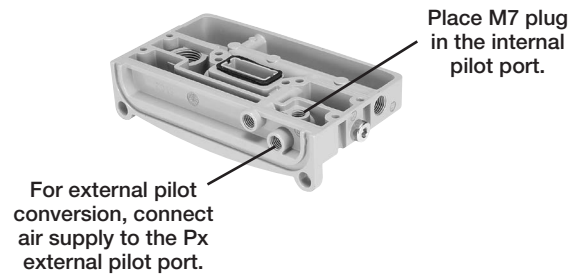

Pilot Pressure Requirements

Internal pilot pressure is supplied to the entire manifold from the right hand end plate, where the main pressure for the front row of valves is connected to the pilot pressure galley.

Maximum pilot pressure is 120 PSI. For applications requiring working pressures from 120 to 145 PSI, an external pilot supply less than 120 PSI is required.

Valve Number	Minimum Pilot Pressure	Maximum Pilot Pressure
HMEVX2049A	40 PSI	120 PSI
HM2VX2049A	25 PSI	120 PSI
HM5VX2049A	45 PSI	120 PSI
HMNVX2049A	40 PSI	120 PSI
HMPVX2049A	40 PSI	120 PSI
HMQVX2049A	40 PSI	120 PSI

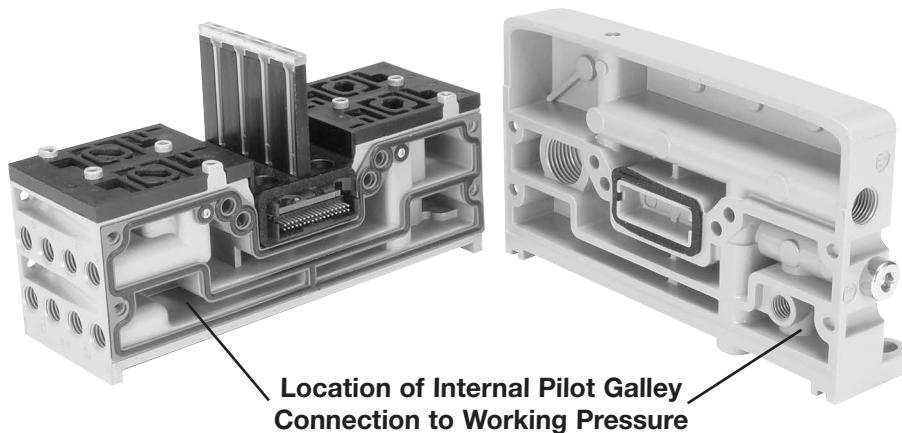

Single Solenoid - Single Address Manifolds

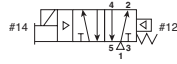

Single Pressure At Inlet Port 1:

De-energized position – Solenoid operator #14 de-energized. Pressure at inlet port 1 connected to outlet port 2. Outlet port 4 connected to exhaust port 5.

Energized position – Solenoid operator #14 energized. Pressure at inlet port 1 connected to outlet port 4. Outlet port 2 connected to exhaust port 3.

HMEVX2049A - Single Address Manifolds

Valve Position A		Valve Position C	
Output 0			
On	Off	On	Off
1→4	1→2	1→4	1→2
3←2	5←4	3←2	5←4
Valve Position B			
Output 1			
On	Off	On	Off
1→4	1→2	1→4	1→2
3←2	5←4	3←2	5←4
Valve Position D			
Output 3			
On	Off	On	Off
1→4	1→2	1→4	1→2
3←2	5←4	3←2	5←4

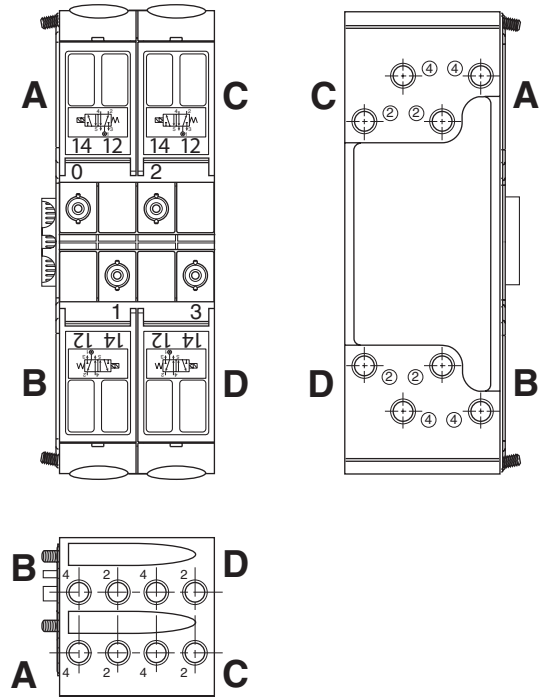

Single Solenoid - Double Address Manifolds

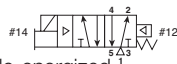

Single Pressure At Inlet Port 1:

De-energized position – Solenoid operator #14 de-energized. Pressure at inlet port 1 connected to outlet port 2. Outlet port 4 connected to exhaust port 5.

Energized position – Solenoid operator #14 energized. Pressure at inlet port 1 connected to outlet port 4. Outlet port 2 connected to exhaust port 3.

HMEVX2049A - Double Address Manifolds

Valve Position A				Valve Position C			
Output 0		Output 1		Output 4		Output 5	
On	Off	On	Off	On	Off	On	Off
1→4	1→2	Output Lost		1→4	1→2	Output Lost	
3←2	5←4	1→2	1→2	3←2	5←4	1→2	1→2
		5←4	5←4			5←4	5←4
Valve Position B				Valve Position D			
Output 3		Output 2		Output 7		Output 6	
On	Off	On	Off	On	Off	On	Off
Output Lost		1→4	1→2	Output Lost		1→4	1→2
1→2	1→2	3←2	5←4	1→2	1→2	3←2	5←4
5←4	5←4			5←4	5←4		

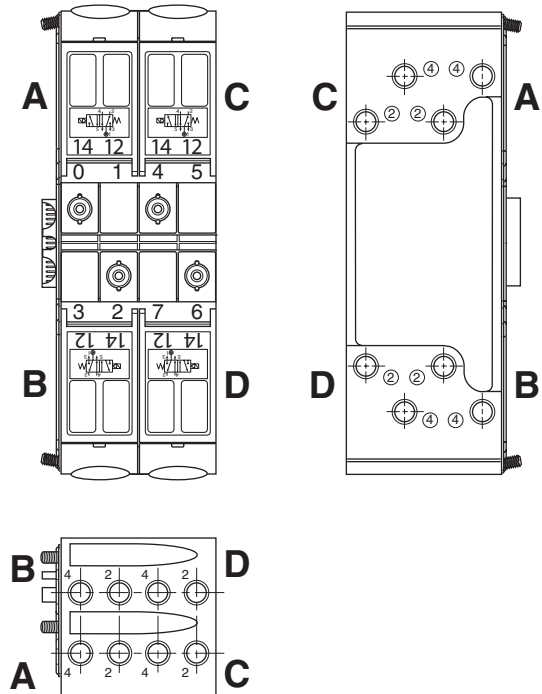

D

Subbase & Manual Valves

H Series Micro

Modulflex Series

H Series ISO

Network Connectivity

DX ISOMAX Series

Valvair II Series



For inventory, lead times, and kit lookup, visit www.pdnplu.com

Double Solenoid - Double Address Manifolds, Last state #12 Energized or #14 Energized

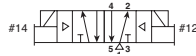

Single Pressure At Inlet Port 1:

Solenoid operator #14 energized last. Pressure at inlet port 1 connected to outlet port 4. Outlet port 2 connected to exhaust port 3.

Solenoid operator #12 energized last. Pressure at inlet port 1 connected to outlet port 2. Outlet port 4 connected to exhaust port 5.

A 2-Position, Double Solenoid Valve is a detented valve. When the output is removed, the spool remains in its position.

HM2VX2049A - Double Address Manifolds - Last state #12 Energized

Valve Position A				Valve Position C			
Output 0		Output 1		Output 4		Output 5	
On	Off	On	Off	On	Off	On	Off
1→4	1→2	1→2	1→2	1→4	1→2	1→2	1→2
3←2	5←4	5←4	5←4	3←2	5←4	5←4	5←4

Valve Position B				Valve Position D			
Output 3		Output 2		Output 7		Output 6	
On	Off	On	Off	On	Off	On	Off
1→2	1→2	1→4	1→2	1→2	1→2	1→4	1→2
5←4	5←4	3←2	5←4	5←4	5←4	3←2	5←4

HM2VX2049A - Double Address Manifolds - Last state #14 Energized

Valve Position A				Valve Position C			
Output 0		Output 1		Output 4		Output 5	
On	Off	On	Off	On	Off	On	Off
1→4	1→4	1→2	1→4	1→4	1→4	1→2	1→4
3←2	3←2	5←4	3←2	3←2	3←2	5←4	3←2

Valve Position B				Valve Position D			
Output 3		Output 2		Output 7		Output 6	
On	Off	On	Off	On	Off	On	Off
1→2	1→4	1→4	1→4	1→2	1→4	1→4	1→4
5←4	3←2	3←2	3←2	5←4	3←2	3←2	3←2

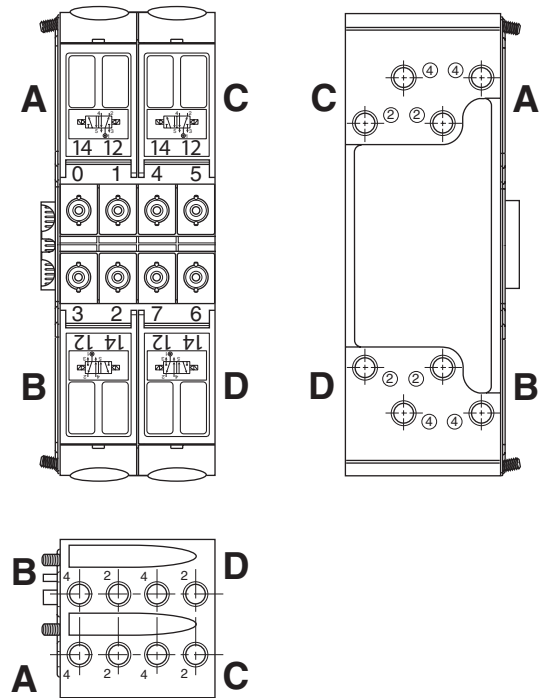

Double Solenoid - Double Address Manifolds

Dual 3-Way, 2-Position NC / NC (NNP)

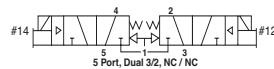

With #14 & #12 operators both de-energized – pressure at inlet port 1 blocked, outlet port 4 connected to exhaust port 5, outlet port 2 connected to exhaust port 3.

With #14 operator energized – pressure at inlet port 1 connected to outlet port 4, exhaust port 5 blocked, outlet port 2 connected to exhaust port 3.

With #12 operator energized – pressure at inlet port 1 connected to outlet port 2, exhaust port 3 blocked, outlet port 4 connected to exhaust port 5.

With #14 & #12 operators both energized – pressure at inlet port 1 connected to outlet ports 4 & 2, exhaust ports 3 & 5 blocked.

HMN VX2049A - Double Address Manifolds

Valve Position A				Valve Position C			
Output 0		Output 1		Output 4		Output 5	
On	Off	On	Off	On	Off	On	Off
1→2	1→1	1→4	1→1	1→2	1→1	1→4	1→1
3→1	3←2	5→1	5←4	3→1	3←2	5→1	5←4

Valve Position B				Valve Position D			
Output 3		Output 2		Output 7		Output 6	
On	Off	On	Off	On	Off	On	Off
1→4	1→1	1→2	1→1	1→4	1→1	1→2	1→1
5→1	5←4	3→1	3←2	5→1	5←4	3→1	3←2

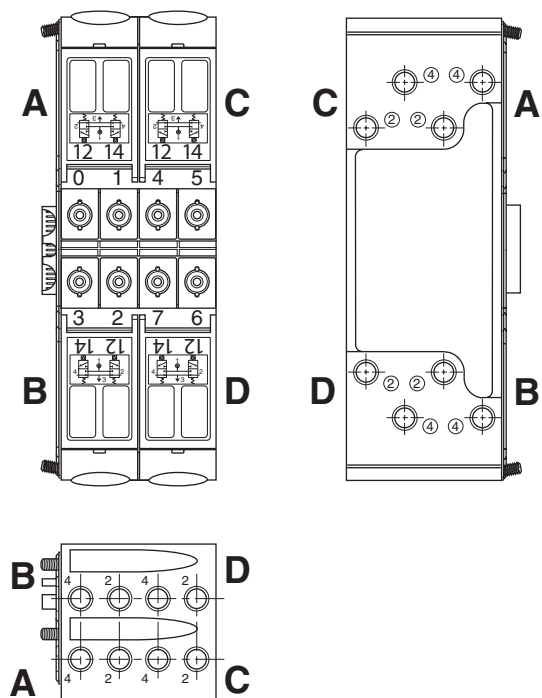

For inventory, lead times, and kit lookup, visit www.pdnplu.com

Double Solenoid - Double Address Manifolds

**Dual 3-Way, 2-Position
 NO / NO (NP)**

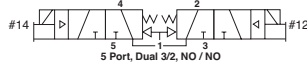

With #14 & #12 operators both de-energized – pressure at inlet port 1 connected to outlet ports 4 & 2, exhaust ports 3 & 5 blocked.

With #14 operator energized – pressure at inlet port 1 connected to outlet port 2, exhaust port 3 blocked, outlet port 4 connected to exhaust port 5.

With #12 operator energized – pressure at inlet port 1 connected to outlet port 4, exhaust port 5 blocked, outlet port 2 connected to exhaust port 3.

With #14 & #12 operators both energized – pressure at inlet port 1 blocked, outlet port 4 connected to exhaust port 5, outlet port 2 connected to exhaust port 3.

HMPVX2049A - Double Address Manifolds

Valve Position A				Valve Position C			
Output 0		Output 1		Output 4		Output 5	
On	Off	On	Off	On	Off	On	Off
1→	1→2	1→	1→4	1→	1→2	1→	1→4
3←2	3→	5←4	5→	3←2	3→	5←4	5→

Valve Position B				Valve Position D			
Output 3		Output 2		Output 7		Output 6	
On	Off	On	Off	On	Off	On	Off
1→	1→4	1→	1→2	1→	1→4	1→	1→2
5←4	5→	3←2	3→	5←4	5→	3←2	3→

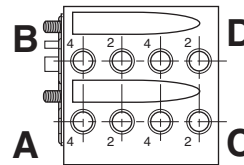
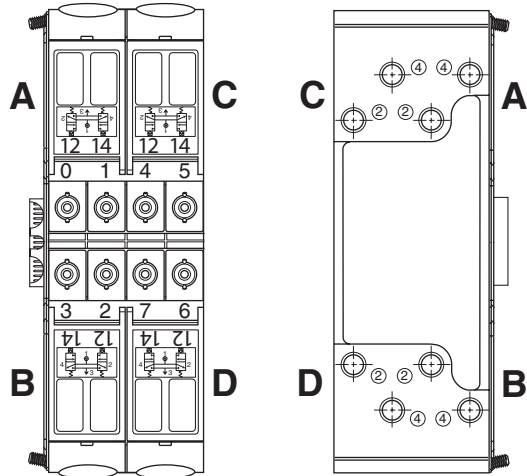

Double Solenoid - Double Address Manifolds

**Dual 3-Way, 2-Position
 14 End NO / 12 End NC
 (NP / NNP)**

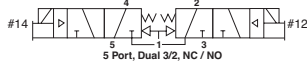

With #14 & #12 operators both de-energized – pressure at inlet port 1 connected to outlet port 4, exhaust port 5 blocked, outlet port 2 connected to exhaust port 3.

With #14 operator energized – pressure at inlet port 1 blocked, outlet port 4 connected to exhaust port 5, outlet port 2 connected to exhaust port 3.

With #12 operator energized – pressure at inlet port 1 connected to outlet ports 4 & 2, exhaust ports 3 & 5 blocked.

With #14 & #12 operators both energized – pressure at inlet port 1 connected to outlet port 2, exhaust port 3 blocked, outlet port 4 connected to exhaust port 5.

HMQVX2049A - Double Address Manifolds

Valve Position A				Valve Position C			
Output 0		Output 1		Output 4		Output 5	
On	Off	On	Off	On	Off	On	Off
1→2	1→	1→	1→4	1→2	1→	1→	1→4
3→	3←2	5←4	5→	3→	3←2	5←4	5→

Valve Position B				Valve Position D			
Output 3		Output 2		Output 7		Output 6	
On	Off	On	Off	On	Off	On	Off
1→	1→4	1→2	1→	1→	1→4	1→2	1→
5←4	5→	3→	3←2	5←4	5→	3→	3←2

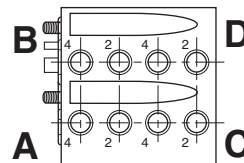
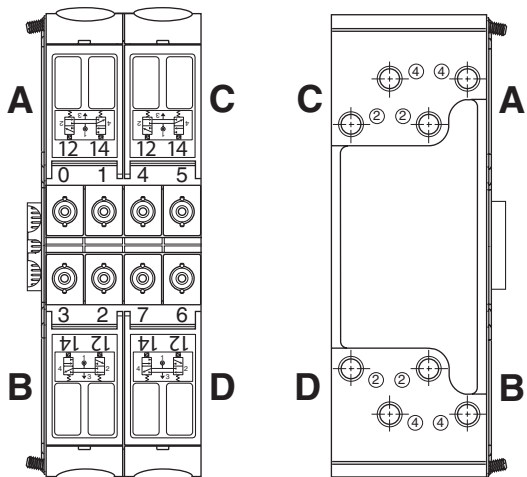

D
 Subbase & Manual Valves
 H Series Micro
 Modulflex Series
 H Series ISO
 Network Connectivity
 DX ISOMAX Series
 Valvair II Series



For inventory, lead times, and kit lookup, visit www.pdnplu.com

Double Solenoid - Double Address Manifolds

3-Position

Function 5: All Ports Blocked

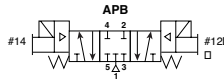

With #12 operator energized – inlet port 1 connected to cylinder port 2, cylinder port 4 connected to exhaust port 5.

With #14 operator energized – inlet port 1 connected to cylinder port 4, cylinder port 2 connected to exhaust port 3.

All ports blocked in the center position.

HM5VX2049A - Double Address Manifolds

Valve Position A			Valve Position C		
Output 0 On	Output 0 Off	Output 0 Off	Output 4 On	Output 4 Off	Output 4 Off
Output 1 Off	Output 1 On	Output 1 Off	Output 5 Off	Output 5 On	Output 5 Off
5→1	5←4	3→1 1→4	5→1	5←4	3→1 1→4
1→4	1→2	1→1 1→2	1→4	1→2	1→1 1→2
3→2	3→1	5→1	3→2	3→1	5→1

Valve Position B			Valve Position D		
Output 2 On	Output 2 Off	Output 2 Off	Output 6 On	Output 6 Off	Output 6 Off
Output 3 Off	Output 3 On	Output 3 Off	Output 7 Off	Output 7 On	Output 7 Off
5→1	5←4	3→1 1→4	5→1	5←4	3→1 1→4
1→4	1→2	1→1 1→2	1→4	1→2	1→1 1→2
3→2	3→1	5→1	3→2	3→1	5→1

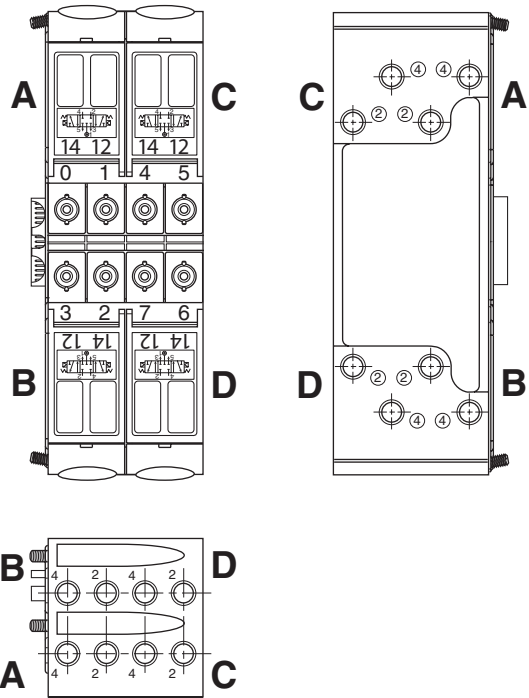

Dual 3/2 valves replace 3-position valves for better performance

3-position center exhaust

A traditional 5/3 center exhaust valve is now replaced by a double 3/2 NC+NC valve module. Both cylinder chambers are exhausted and rod and piston are free to move.

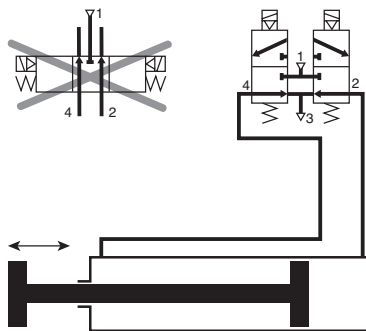

3-position pressure center

A traditional 5/3 pressure center valve is now replaced by a double 3/2 NO+NO valve module. The function is identical.

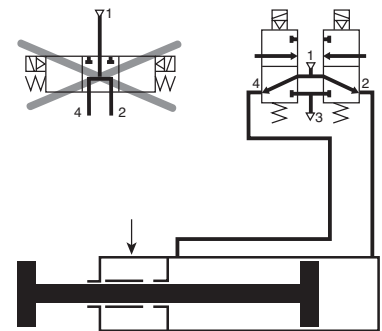

Multiple Pressure Zones

PSM0001 –

All ports open. Common pressure for front and rear manifold.
 Common exhausts.
 Standard gasket included with each manifold and end plate.

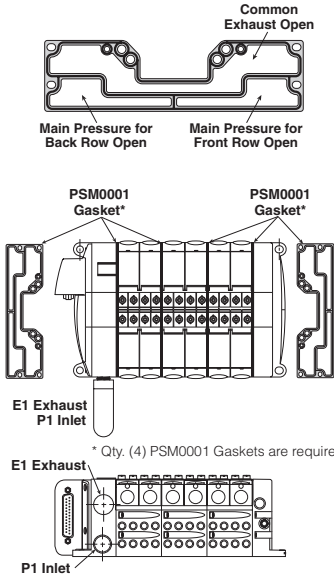

PSM0002 –

Rear manifold blocked for separate pressure supply.
 Common exhausts.
 Flip gasket to block front of manifold.

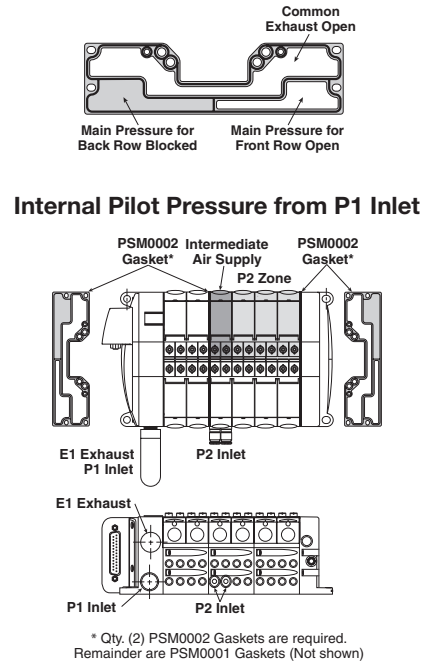

PSM0003 –

Rear manifold blocked for separate pressure supply.
 Exhaust blocked also.
 Flip gasket to block front of manifold.
 If used with bottom ported end plates, second exhaust must be piped from the side of the right end plate.

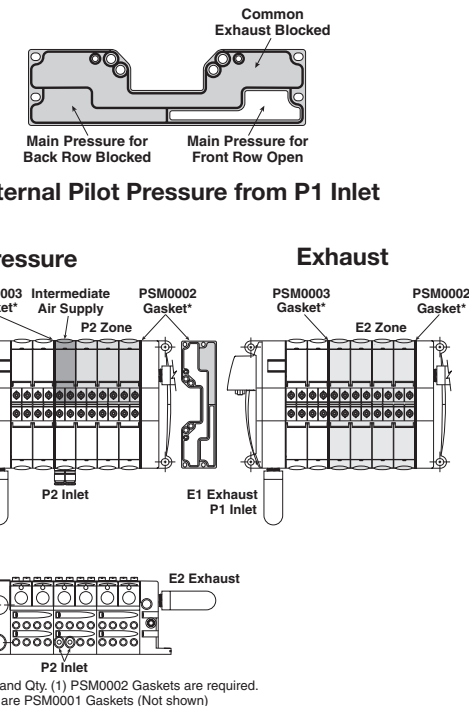

PSM0004 –

All galleys blocked.
 Two pressure zones and two exhaust zones.
 If used with bottom ported end plates, second exhaust must be piped from the side of the right end plate.

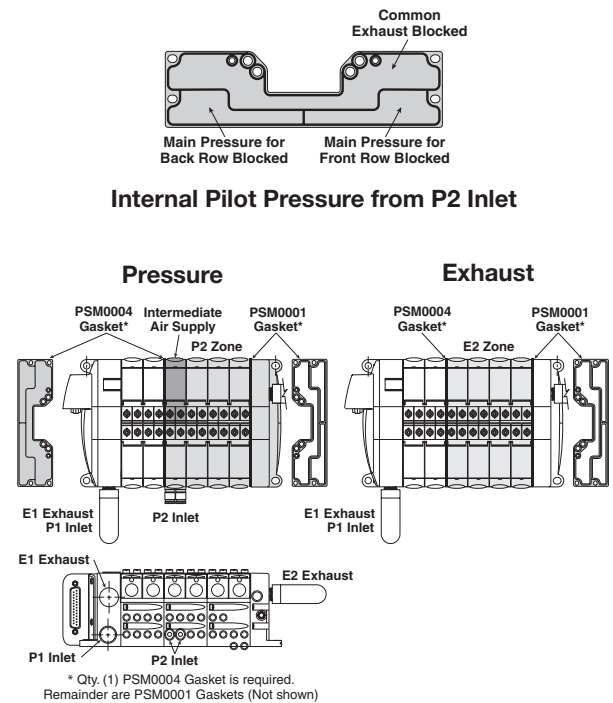

D
 Subbase & Manual Valves
 H Series Micro
 Modulflex Series
 H Series ISO
 Network Connectivity
 DX ISOMAX Series
 Valvair II Series



For inventory, lead times, and kit lookup, visit www.pdnplu.com

Maximum Number of Solenoids

(Maximum Energized Simultaneously)

	25-Pin D-Sub	Moduflex	H Series Fieldbus*
24VDC	24 (24)	24 (24)	32 (32)

* Maximum of 32 solenoids per manifold. With Bus Extension functionality, 4 manifolds with up to 32 solenoids each can be connected on the same network.

25-Pin, D-Sub Connector (Male)

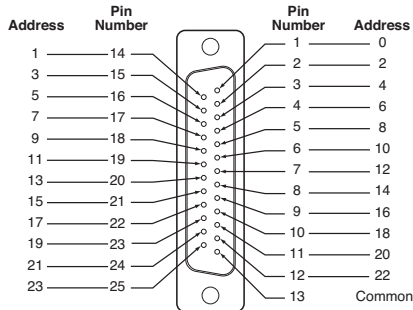

View into End Plate Connector - Male D-Sub, 25-Pin

Single Solenoid Valves Shown
Solenoid is De-energized

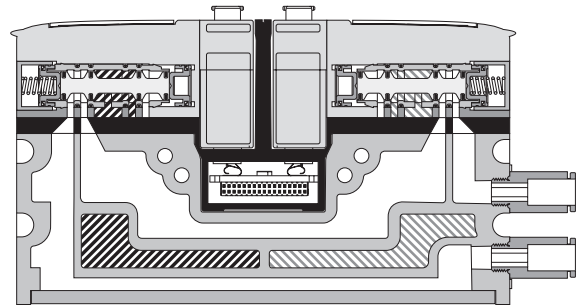

Side Exhaust
 4 Ports Connected to Exhaust Port
 (5 & 3 Common)

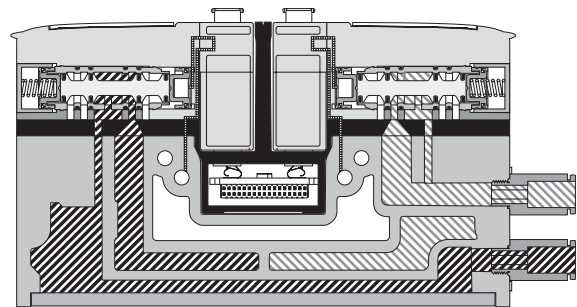

Side Pressure
 2 Ports Connected to Inlet Port 1



D

Subbase & Manual
Valves

H Series
Micro

Moduflex
Series

H Series
ISO

Network
Connectivity

DX ISOMAX
Series

Valvair II
Series

Cv Values - H Series Micro

The charts below represent the minimum required Cv values for pneumatic systems operating at 80 PSI with a 5 PSI pressure drop.

To use the chart, locate the diameter of the cylinder across the horizontal axis, then the average required rod speed of the cycle. The intersection point is Cv value needed.

Grayed out values are not attainable with H Series Micro. Please select a larger Parker valve.

Average Rod Speed (mm/s)	Cylinder Diameter (mm)												
	6	8	10	12	16	20	25	32	40	50	63	80	100
25	0.000	0.001	0.001	0.002	0.003	0.005	0.008	0.013	0.021	0.032	0.051	0.083	0.129
50	0.001	0.002	0.003	0.004	0.007	0.010	0.016	0.026	0.041	0.065	0.103	0.166	0.259
75	0.001	0.002	0.004	0.006	0.010	0.016	0.024	0.040	0.062	0.097	0.154	0.248	0.388
100	0.002	0.003	0.005	0.007	0.013	0.021	0.032	0.053	0.083	0.129	0.205	0.331	0.517
125	0.002	0.004	0.006	0.009	0.017	0.026	0.040	0.066	0.103	0.162	0.257	0.414	0.647
150	0.003	0.005	0.008	0.011	0.020	0.031	0.049	0.079	0.124	0.194	0.308	0.497	0.776
175	0.003	0.006	0.009	0.013	0.023	0.036	0.057	0.093	0.145	0.226	0.359	0.580	0.906
200	0.004	0.007	0.010	0.015	0.026	0.041	0.065	0.106	0.166	0.259	0.411	0.662	1.035
225	0.004	0.007	0.012	0.017	0.030	0.047	0.073	0.119	0.186	0.291	0.462	0.745	1.164
250	0.005	0.008	0.013	0.019	0.033	0.052	0.081	0.132	0.207	0.323	0.513	0.828	1.294
275	0.005	0.009	0.014	0.020	0.036	0.057	0.089	0.146	0.228	0.356	0.565	0.911	1.423
300	0.006	0.010	0.016	0.022	0.040	0.062	0.097	0.159	0.248	0.388	0.616	0.994	1.552
350	0.007	0.012	0.018	0.026	0.046	0.072	0.113	0.185	0.290	0.453	0.719	1.159	1.811
400	0.007	0.013	0.021	0.030	0.053	0.083	0.129	0.212	0.331	0.517	0.822	1.325	2.070
450	0.008	0.015	0.023	0.034	0.060	0.093	0.146	0.238	0.373	0.582	0.924	1.490	2.329
500	0.009	0.017	0.026	0.037	0.066	0.103	0.162	0.265	0.414	0.647	1.027	1.656	2.587

Average Rod Speed (in/s)	Cylinder Diameter (in)																
	5/16"	7/16"	9/16"	3/4"	7/8"	1"	1-1/16"	1-1/8"	1-1/4"	1-1/2"	1-3/4"	2"	2-1/2"	3"	3-1/4"	3-5/8"	4"
1	0.001	0.002	0.003	0.005	0.006	0.008	0.010	0.011	0.013	0.019	0.026	0.034	0.053	0.076	0.090	0.111	0.136
2	0.002	0.003	0.005	0.010	0.013	0.017	0.019	0.021	0.026	0.038	0.052	0.068	0.106	0.153	0.179	0.223	0.271
3	0.002	0.005	0.008	0.014	0.019	0.025	0.029	0.032	0.040	0.057	0.078	0.102	0.159	0.229	0.269	0.334	0.407
4	0.003	0.006	0.011	0.019	0.026	0.034	0.038	0.043	0.053	0.076	0.104	0.136	0.212	0.305	0.358	0.446	0.543
5	0.004	0.008	0.013	0.024	0.032	0.042	0.048	0.054	0.066	0.095	0.130	0.170	0.265	0.382	0.448	0.557	0.678
6	0.005	0.010	0.016	0.029	0.039	0.051	0.057	0.064	0.079	0.114	0.156	0.204	0.318	0.458	0.537	0.669	0.814
7	0.006	0.011	0.019	0.033	0.045	0.059	0.067	0.075	0.093	0.134	0.182	0.237	0.371	0.534	0.627	0.780	0.950
8	0.007	0.013	0.021	0.038	0.052	0.068	0.077	0.086	0.106	0.153	0.208	0.271	0.424	0.611	0.717	0.891	1.085
9	0.007	0.015	0.024	0.043	0.058	0.076	0.086	0.097	0.119	0.172	0.234	0.305	0.477	0.687	0.806	1.003	1.221
10	0.008	0.016	0.027	0.048	0.065	0.085	0.096	0.107	0.132	0.191	0.260	0.339	0.530	0.763	0.896	1.114	1.357
11	0.009	0.018	0.030	0.052	0.071	0.093	0.105	0.118	0.146	0.210	0.286	0.373	0.583	0.839	0.985	1.226	1.492
12	0.010	0.019	0.032	0.057	0.078	0.102	0.115	0.129	0.159	0.229	0.312	0.407	0.636	0.916	1.075	1.337	1.628
14	0.012	0.023	0.038	0.067	0.091	0.119	0.134	0.150	0.185	0.267	0.364	0.475	0.742	1.068	1.254	1.560	1.899
16	0.013	0.026	0.043	0.076	0.104	0.136	0.153	0.172	0.212	0.305	0.415	0.543	0.848	1.221	1.433	1.783	2.171
18	0.015	0.029	0.048	0.086	0.117	0.153	0.172	0.193	0.238	0.343	0.467	0.611	0.954	1.374	1.612	2.006	2.442
20	0.017	0.032	0.054	0.095	0.130	0.170	0.191	0.215	0.265	0.382	0.519	0.678	1.060	1.526	1.791	2.229	2.713

D
 Subbase & Manual Valves
 H Series Micro
 Modulflex Series
 H Series ISO
 Network Connectivity
 DX ISOMAX Series
 Valvair II Series



For inventory, lead times, and kit lookup, visit www.pdnplu.com

D20

Parker Hannifin Corporation
 Pneumatic Division
 Richland, Michigan
www.parker.com/pneumatics

Flow Characteristics

Dual 3/2

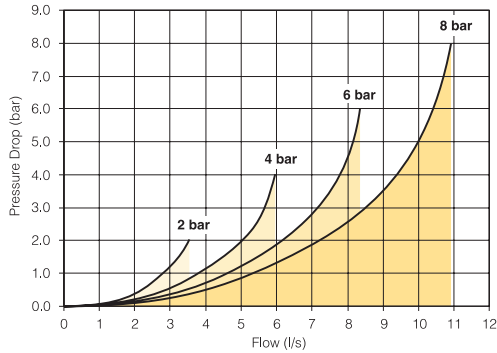

Operating pressure: 39 to 120.3 PSI (2.7 to 8.3 bar)
 Change-over time (side 14): Actuation 15 ms
 Return 20 ms P = 6b
 Change-over time (side 12): 15 ms / 25 ms P = 6b
 Flow (acc. to ISO 6358): c = 1.2 NI/s x bar
 b = 0.13
 Qn = 4.6 NI/s
 Qmax = 8.4 NI/s

5/2 single and double solenoid

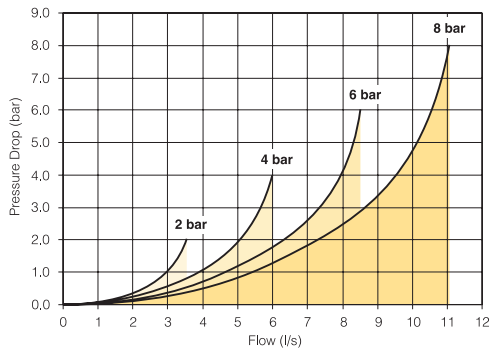

Operating pressure: Single solenoid 39 to 120.3 PSI (2.7 to 8.3 bar)
 Double solenoid 24.6 to 120.3 PSI (1.7 to 8.3 bar)
 Change-over time: Single solenoid Actuation 15 ms
 Return 20 ms P = 6b
 Double solenoid 13 ms / 13 ms P = 6b
 Flow (acc. to ISO 6358): c = 1.2 NI/s x bar
 b = 0.13
 Qn = 4.7 NI/s
 Qmax = 8.5 NI/s

5/3 all ports blocked

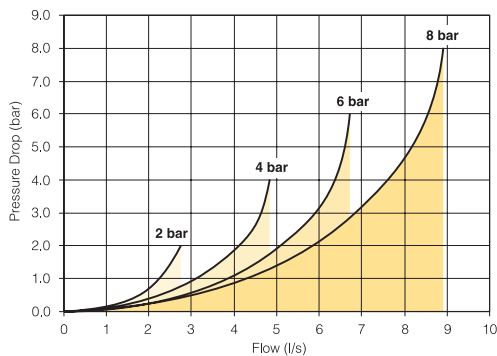

Operating pressure: 39 to 120.3 PSI (2.7 to 8.3 bar)
 Change-over time: Actuation 20 ms
 Return 20 ms P = 6b
 Flow (acc. to ISO 6358): c = 1 NI/s x bar
 b = 0.14
 Qn = 3.8 NI/s
 Qmax = 6.7 NI/s

Characteristics

Fluid: Air or inert gas
 Filtered 40 μ
 Class 5 (according to ISO 8573-1)
 Dry class 4 (according to ISO 8573-1)
 Non-lubricated or lubricated
 Storage temperature: 104°F to 158°F (-40°C to 70°C)
 Working temperature: 5°F to 122°F (-15°C to 50°C)
 Vibration: according to IEC 68-2-6
 2G to 150 Hz
 Shock: according to IEC 68-2-27
 15G 11 ms

Operating pressure: -13 to 120.3 PSI (-0.9 to 8.3 bar)
 with external pressure 87 PSI (6 bar)
 Piloting pressure: 37 to 120.3 PSI (2.7 to 8.3 bar)
 Exhaust collection: Independent exhaust collection
 Rated coil voltage: 24 VDC -15 % / +10 %
 Electrical connection: Not polarized
 Coil insulation: Class B
 Power consumption: 1 W (42 mA) with LED
 Duty factor: 100 % at 68°F (20°C)



For inventory, lead times, and kit lookup, visit www.pdnplu.com

D21

Parker Hannifin Corporation
 Pneumatic Division
 Richland, Michigan
www.parker.com/pneumatics

D

Subbase & Manual Valves

H Series Micro

Moduflex Series

H Series ISO

Network Connectivity

DX ISOMAX Series

Valvair II Series

25-pin, D-Sub with H Series Micro Valves, Side Ported

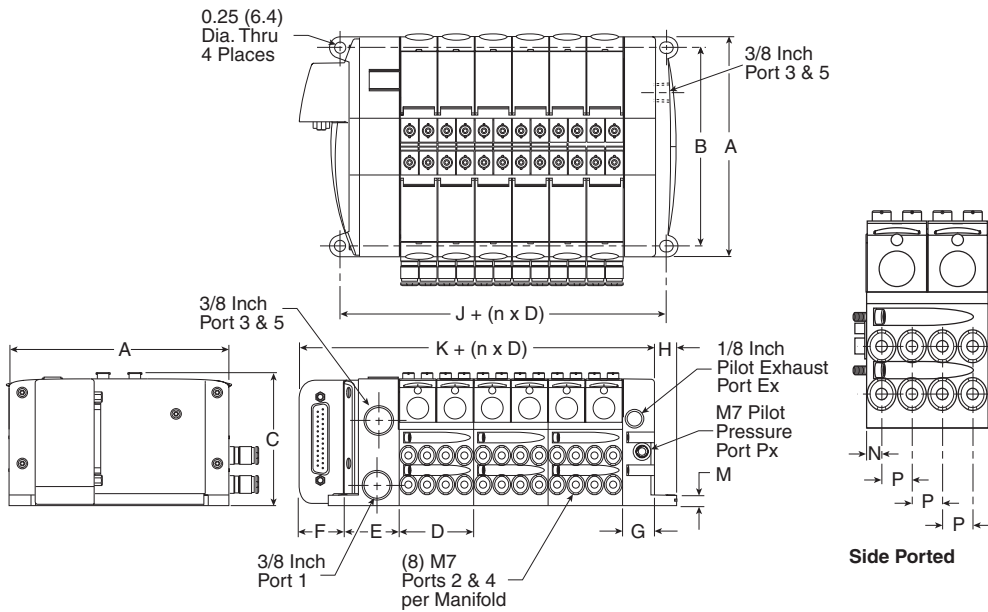

Dimensions

A	B	C	D
4.88	4.41	2.95	1.65
(124.0)	(112.0)	(75.0)	(42.0)

E	F	G	H
1.22	1.02	0.71	0.49
(31.0)	(26.0)	(18.0)	(12.5)

J	K	M	N
2.28	3.44	0.24	0.21
(58.0)	(87.5)	(6.1)	(5.2)

P
0.41
(10.5)

Inches (mm)
 n = Number of manifolds

Side Ported

25-pin, D-Sub with H Series Micro Valves, Bottom Ported

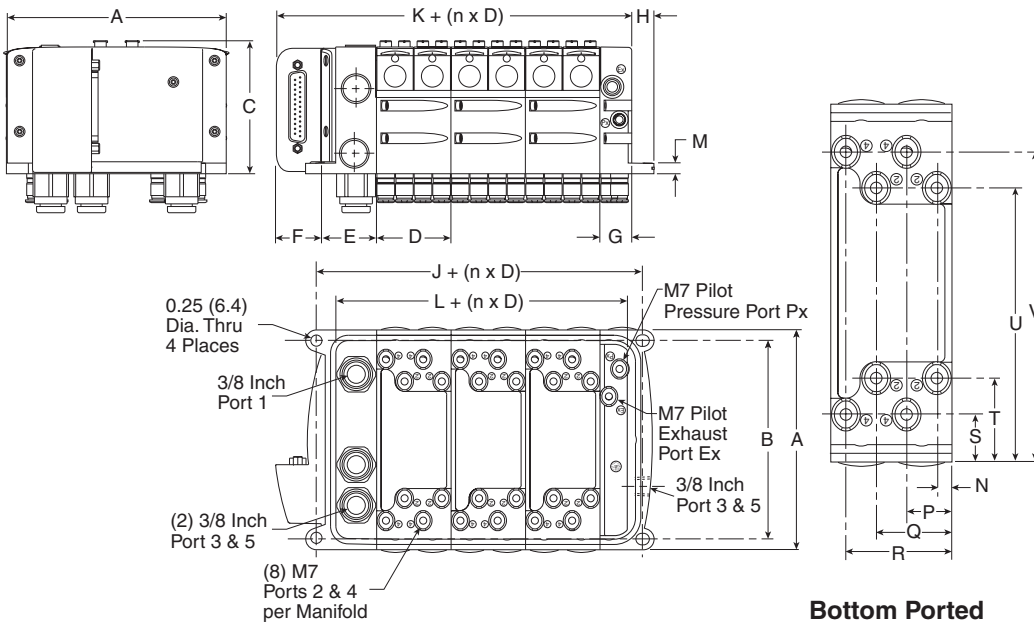

Dimensions

A	B	C	D
4.88	4.41	2.95	1.65
(124.0)	(112.0)	(75.0)	(42.0)

E	F	G	H
1.22	1.02	0.71	0.49
(31.0)	(26.0)	(18.0)	(12.5)

J	K	L	M
2.28	3.44	1.69	0.24
(58.0)	(87.5)	(43.0)	(6.1)

N	P	Q	R
0.21	0.62	1.03	1.45
(5.3)	(15.8)	(26.3)	(36.8)

S	T	U	V
0.64	1.14	3.73	4.23
(16.40)	(29.0)	(94.9)	(107.4)

Inches (mm)
 n = Number of manifolds

Bottom Ported Detail

Note:
 See Fieldbus Section for the dimensions of manifolds utilizing the H Series Fieldbus, Turck, or Modflex end plate type.



For inventory, lead times, and kit lookup, visit www.pdnplu.com

D22

Parker Hannifin Corporation
 Pneumatic Division
 Richland, Michigan
www.parker.com/pneumatics

D
 Subbase & Manual Valves
 H Series Micro
 Modflex Series
 H Series ISO
 Network Connectivity
 DX ISOMAX Series
 Valvair II Series

H Series Fieldbus with H Series Micro Valves, Side Ported

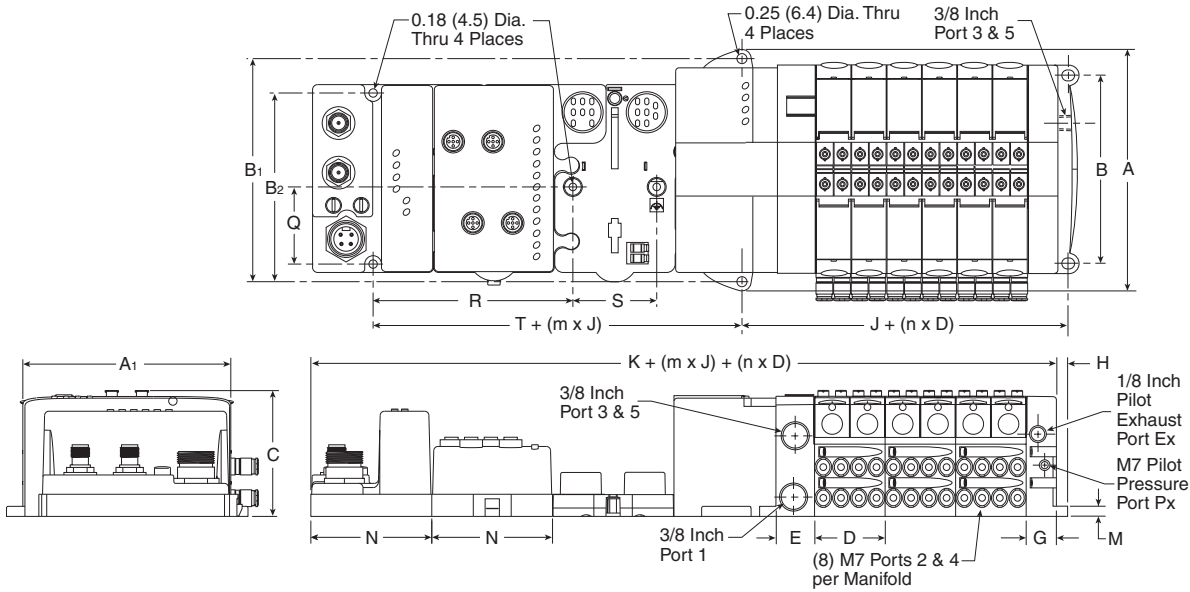

Dimensions

A	A₁	B	B₁	B₂	C	D	E	G
5.67 (144.0)	4.88 (124.0)	4.41 (112.0)	5.24 (133.0)	4.02 (102.0)	2.95 (75.0)	1.65 (42.0)	0.91 (23.0)	0.71 (18.0)
H	J	K	M	N	Q	R	S	T
0.49 (12.5)	2.72 (69.0)	7.32 (186.0)	0.24 (6.1)	2.83 (72.0)	1.81 (46.0)	4.72 (120.0)	2.01 (51.0)	2.01 (51.0)

Inches (mm)
 n = Number of Manifolds
 m = Number of Modules

H Series Fieldbus with H Series Micro Valves, Bottom Ported

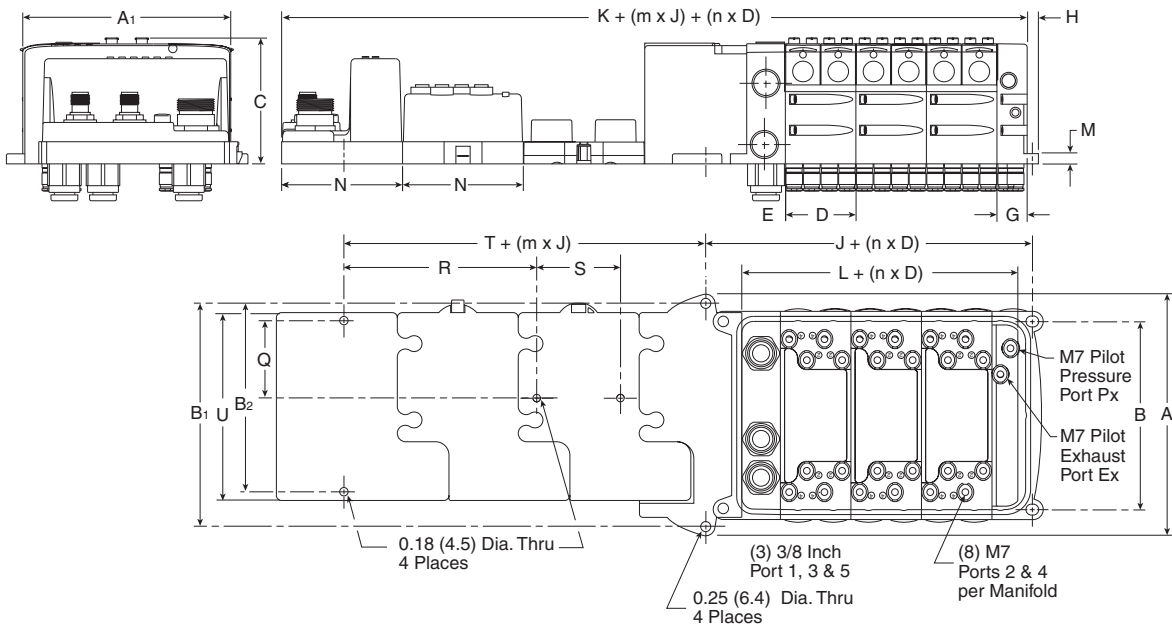

Dimensions

A	A₁	B	B₁	B₂	C	D	E	G	H
5.67 (144.0)	4.88 (124.0)	4.41 (112.0)	5.24 (133.0)	4.02 (102.0)	2.95 (75.0)	1.65 (42.0)	0.91 (23.0)	0.71 (18.0)	0.49 (12.5)
J	K	L	M	N	Q	R	S	T	U
2.72 (69.0)	7.32 (186.0)	1.69 (43.0)	0.24 (6.1)	2.83 (72.0)	1.81 (46.0)	4.72 (120.0)	2.01 (51.0)	2.01 (51.0)	4.41 (112)

Inches (mm)
 n = Number of Manifolds
 m = Number of Modules



For inventory, lead times, and kit lookup, visit www.pdnplu.com

D23

Parker Hannifin Corporation
 Pneumatic Division
 Richland, Michigan
www.parker.com/pneumatics

D

Subbase & Manual Valves

H Series Micro

Modulflex Series

H Series ISO

Network Connectivity

DX ISOMAX Series

Valvair II Series

Moduflex with H Series Micro Valves, Side Ported

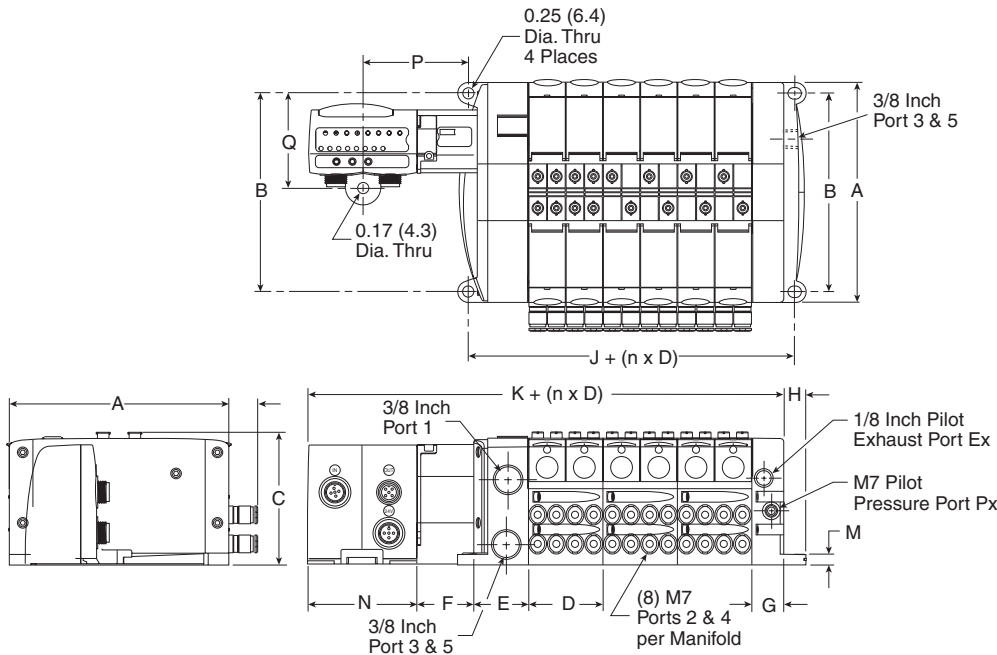

Dimensions

A	B	C	D
4.88 (124.0)	4.41 (112.0)	2.95 (75.0)	1.65 (42.0)
E	F	G	H
1.22 (31.0)	1.28 (32.5)	0.71 (18.0)	0.49 (12.5)
J	K	M	N
2.28 (58.0)	6.10 (155.0)	0.24 (6.1)	2.40 (61.0)
P	Q		
2.36 (60.0)	2.07 (52.55)		

Inches (mm)
 n = Number of manifolds

Moduflex with H Series Micro Valves, Bottom Ported

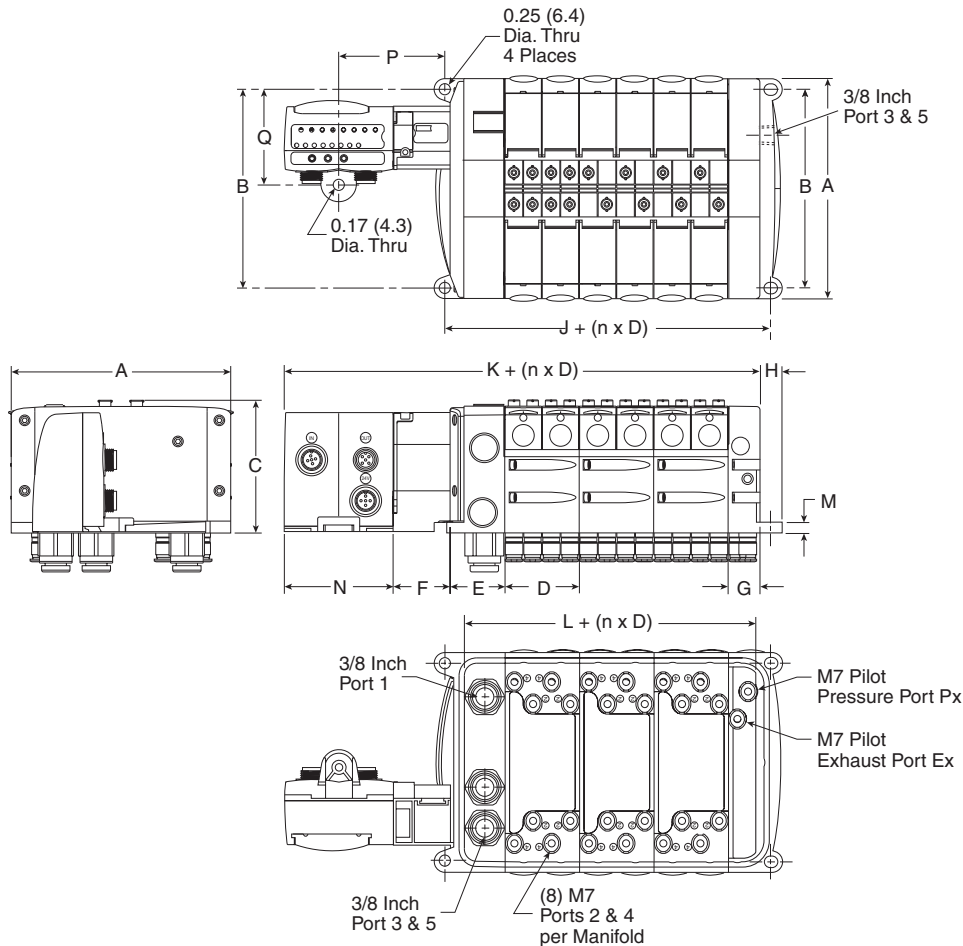

Dimensions

A	B	C	D
4.88 (124.0)	4.41 (112.0)	2.95 (75.0)	1.65 (42.0)
E	F	G	H
1.22 (31.0)	1.02 (26.0)	0.71 (18.0)	0.49 (12.5)
J	K	L	M
2.28 (58.0)	6.10 (155.0)	1.69 (43.0)	0.24 (6.1)
N	P	Q	
2.40 (61.0)	2.36 (60.0)	2.07 (52.55)	

Inches (mm)
 n = Number of manifolds

D
 Subbase & Manual Valves
 H Series Micro
 Moduflex Series
 H Series ISO
 Network Connectivity
 DX ISOMAX Series
 Valvair II Series



For inventory, lead times, and kit lookup, visit www.pdnplu.com

D24

Parker Hannifin Corporation
 Pneumatic Division
 Richland, Michigan
www.parker.com/pneumatics

Turck with H Series Micro Valves, Side Ported

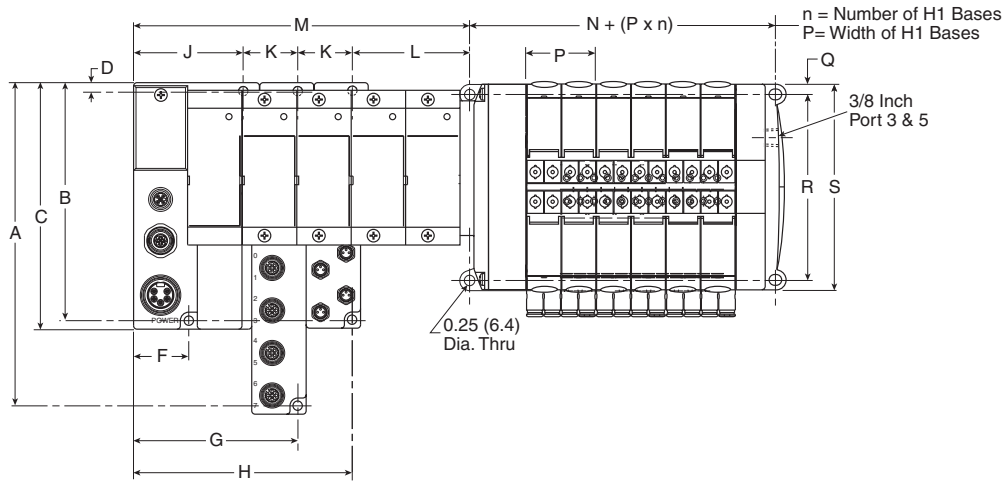

Dimensions

A	B	C	D
7.48 (190)	5.51 (140)	5.71 (145)	0.20 (5)
F	G	H	J
1.28 (32.5)	3.79 (96.5)	5.06 (128.5)	2.53 (64.5)
K	L	M	N
1.26 (32)	2.54 (64)	See note 1	2.28 (58)
P	Q	R	S
1.65 (42)	.19 (4.9)	4.41 (112)	4.88 (124)

Note 1: $M = J + L + n_2 \times K$, where n_2 = Number of Turck input / output modules
 Inches (mm)

Sandwich Regulator

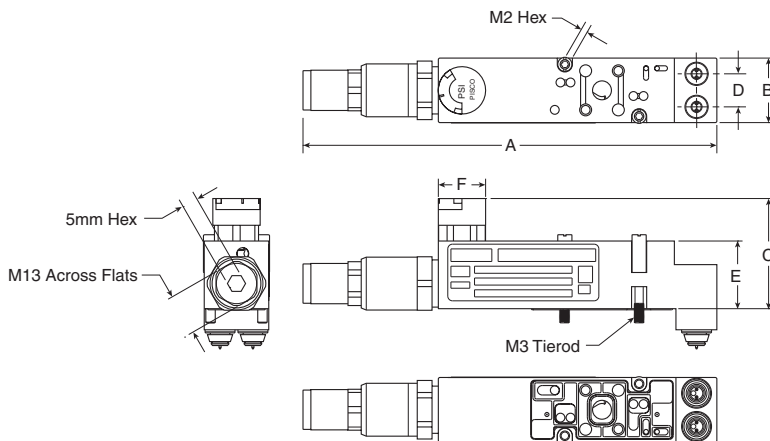

Dimensions

A	B	C	D
5.20 (132)	0.81 (20.5)	1.38 (35)	0.41 (10.5)
E	F		
0.85 (21.5)	0.59Ø (15Ø)		

Inches (mm)

M7 Fittings

PS567900 – Kit PSM0013

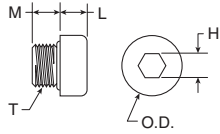

Part no.	L	M	H hex	T thread	O.D.
PS567900	0.18 (4.5)	0.20 (5)	0.16 (4)	M7 x 1	0.39 (10)

PS567906

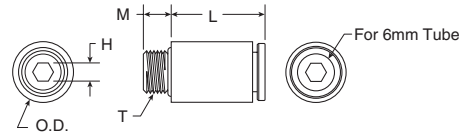

Part no.	Tube size	L	M	H Hex	T thread	O.D.
PS567906	6mm	0.63 (16)	0.20 (5)	0.12 (3)	M7 x 1	0.39 (10)

PS567904

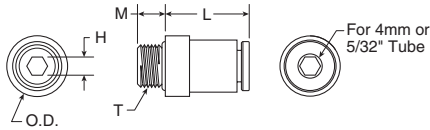

Part no.	Tube size	L	M	H Hex	T thread	O.D.
PS567904	4mm or 5/32"	0.55 (14)	0.20 (5)	0.12 (3)	M7 x 1	0.39 (10)

PS567925

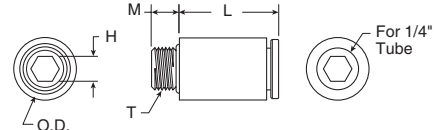

Part no.	Tube size	L	M	H Hex	T thread	O.D.
PS567925	1/4"	0.65 (16.5)	0.18 (4.6)	0.16 (4)	M7 x 1	0.41 (10.3)

1/8 Inch Fittings

PS568204

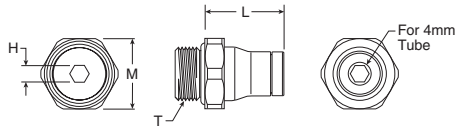

Part No.	Tube Size	L	M Hex	H Hex	T Thread
PS568204	4mm	0.57 (14.5)	0.51 (13)	0.12 (3)	G1 /8

PS568215

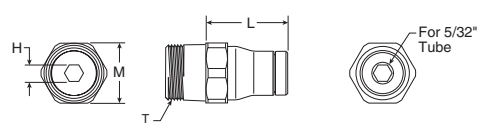

Part No.	Tube Size	L	M Hex	H Hex	T Thread
PS568215	5/32"	0.59 (15)	0.43 (11)	0.12 (3)	1/8 NPT

PS568206

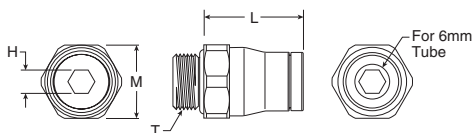

Part no.	Tube size	L	M Hex	H Hex	T thread
PS568206	6mm	0.69 (17.5)	0.51 (13)	0.16 (4)	G1/8

PS568225

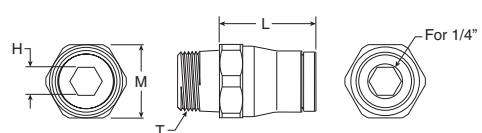

Part no.	Tube size	L	M Hex	H Hex	T thread
PS568225	1/4"	0.67 (17)	0.51 (13)	0.20 (5)	1/8 NPT

D
 Subbase & Manual Valves
 H Series Micro
 Modulflex Series
 H Series ISO
 Network Connectivity
 DX ISOMAX Series
 Valvair II Series



For inventory, lead times, and kit lookup, visit www.pdnplu.com

3/8 Inch Fittings

PS568308

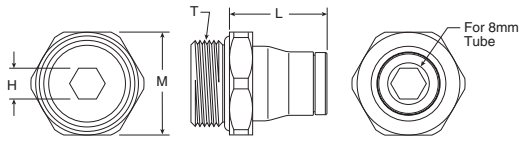

Part no.	Tube size	L	M Hex	H Hex	T thread
PS568308	8mm	0.75 (19)	0.79 (20)	0.24 (6)	G3/8

PS568325

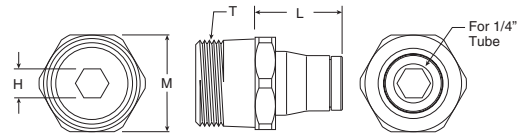

Part no.	Tube size	L	M Hex	H Hex	T thread
PS568325	1/4"	0.67 (17)	0.71 (18)	0.20 (5)	3/8 NPT

PS568310

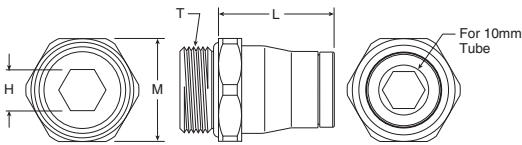

Part no.	Tube size	L	M Hex	H Hex	T thread
PS568310	10mm	0.89 (22.5)	0.79 (20)	0.31 (8)	G3/8

PS568338

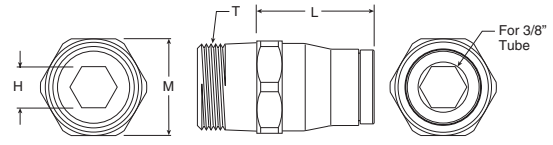

Part no.	Tube size	L	M Hex	H Hex	T thread
PS568338	3/8"	0.91 (23)	0.71 (18)	0.31 (8)	3/8 NPT

D

Subbase & Manual
Valves

H Series
Micro

Moduflex
Series

H Series
ISO

Network
Connectivity

DX ISOMAX
Series

Valvair II
Series



For inventory, lead times, and kit lookup, visit www.pdnplu.com

Features

Moduflex Series

The Moduflex Valve System redefines flexibility for pneumatic users. Whether configured from basic components or ordered as a pre-assembled and tested valve manifold, Moduflex flexibility is unmatched in the market place.

Ports

- Size 1: Push-in connectors for 5/32, 1/4 inch, 4, 6mm OD tube
- Size 2: Push-in connectors for 1/4, 3/8, 1/2 inch, 6, 8, 10 OD tube

Mounting

- S Series – Individual subbase
- T Series – Manifold mount with individual connectors
- V Series – Manifold mount with collective wiring or fieldbus

Network Connectivity Options

- Industrial Ethernet – EtherNet/IP, PROFINET, Modbus TCP, PowerLink, EtherCAT
- IO-Link – Class A & Class B

Solenoids

- 1.0 Watt
- 24 VDC
- Compatible with PNP or NPN outputs

Certification / approval

- IP65 rated
- CE, as marked

Material specifications

End plates (T and V series)	Plastic
Fasteners	Nickel plated steel
Spool	Aluminum and nitrile rubber or ceramic plate
Subbase or manifold	Plastic
Valve body	Plastic

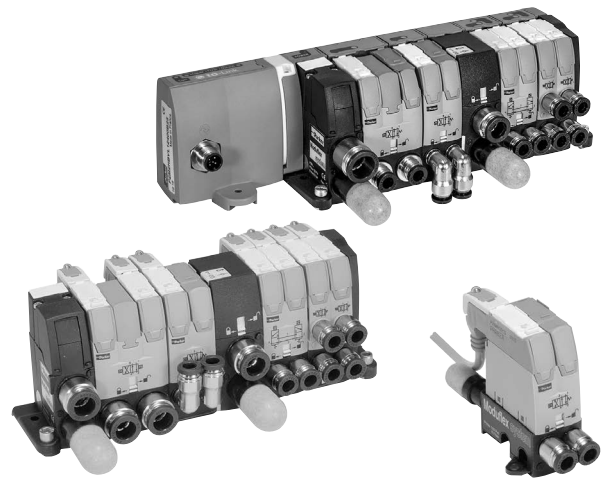

Operating information

Operating pressure:	Vacuum to 123 PSIG (Vacuum to 8.3 bar)
Operating temperature:	5°F to 140°F (-15°C to 60°C)
Fieldbus operating temperature:	32°F to 130°F (0°C to 55°C)

Most popular.

D	Subbase & Manual Valves
H Series Micro	
Moduflex Series	
H Series ISO	
Network Connectivity	
DX ISOMAX Series	
Valvair II Series	



For inventory, lead times, and kit lookup, visit www.pdnplu.com

Features

Module Series Selection and Assembly Procedures

Moduflex system provides a complete choice of either stand-alone valves, short-build valve islands, or large valve island configurations. Electrical control connections may be individual or island integrated. Peripheral modules add complementary functions — flow control, pressure regulation, P.O. check valves and vacuum generators can be added directly to the valve or used as a stand alone product.

Moduflex gives machine builders maximum flexibility to assemble each automation system step by step using basic modules.

Valve islands can be easily assembled using the following procedure.

1. Assemble the required valve island with the basic modules.
2. Mount the valve island on the machine together with any stand-alone valves and peripheral modules.
3. Select and install the required clip-on pneumatic and electrical connectors.

“S” Series Stand Alone Valves

For isolated cylinders on a machine, it is preferable to locate the valve close by. Therefore a stand-alone module is ideal. Response time and air consumption are then reduced to a minimum. Peripheral modules can be installed directly into the valve.



“S” Series Size 1 Single Solenoid



“S” Series Size 1 Single Air Pilot

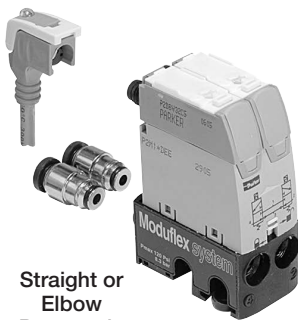

Straight or Elbow Pneumatic Connectors

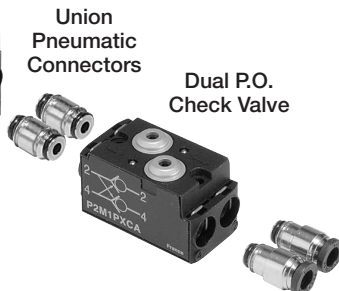

Union Pneumatic Connectors

Dual P.O. Check Valve

Subbase & Manifold Valve Products “S” & “T” Series

“T” Series Valve Island Modules with Individual Connectors

For small groups of cylinders requiring short localized valve islands, it is convenient to use individual electrical connector islands.



“T” Series Island Modules

“T” Series modules are easily assembled to form a complete manifold. All electrical connectors are individual and pneumatic connectors are of the push-in tube type. Modules with different functions and flow passages may be combined in the same island manifold, giving total flexibility to adapt to all machine requirements.

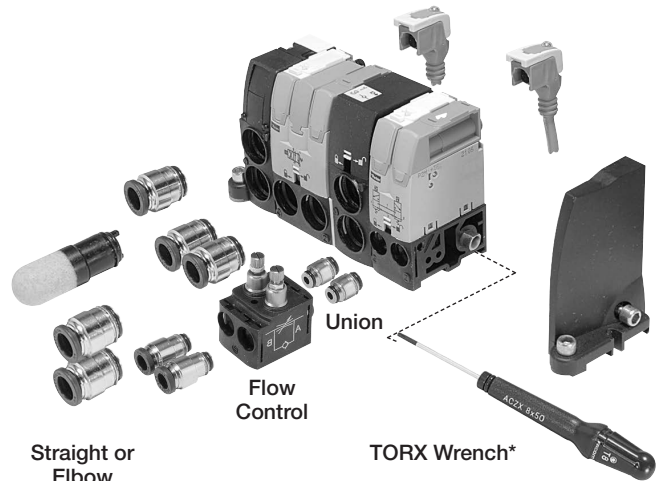

Straight or Elbow Pneumatic Connectors

Flow Control

Union

TORX Wrench*

* Maximum torque rating 10.6 in. lbs. (1.2 Nm).



M8 2-pin, male connector

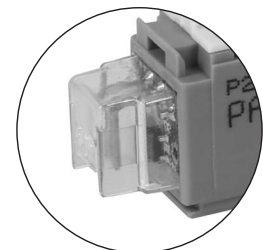

Clip Connector with LED & surge protection



For inventory, lead times, and kit lookup, visit www.pdnplu.com

Features

“V” Series Valve Island Modules with Integrated Connections

When the number of valves is larger, modular islands are easily assembled using the integrated electrical connection series. These islands are then connected to the control PLC, with a multi-connector cable or with a fieldbus connection.



“V” Series with 20-Pin Connector



“V” Series with Field Bus Connection

“V” Series modules are easily assembled to form a complete manifold. All pneumatic connectors are of the push-in tube type. When the valve island has been installed, it is a simple operation to separate the field bus module from the valve island using the quick release lever. Modules with different functions and flow passages may be combined in the same island manifold, giving total flexibility to adapt to all machine requirements.

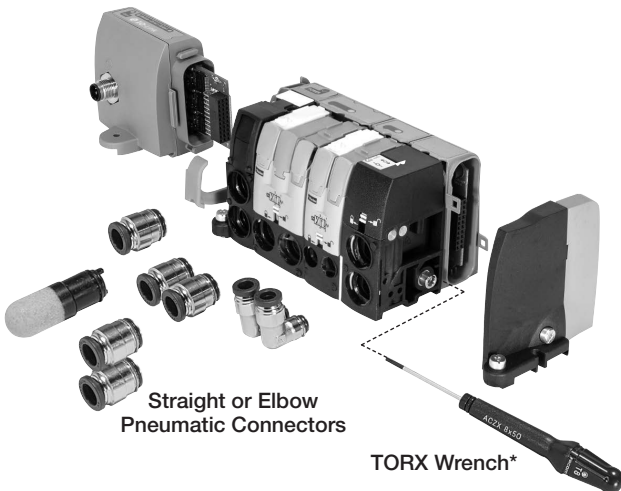

Straight or Elbow Pneumatic Connectors

TORX Wrench*

* Maximum torque rating 10.6 in. lbs. (1.2 Nm).

“P” Series Peripheral Modules

Peripheral Modules are available and can be mounted directly to valves or used as a stand alone product. These modules answer the complementary needs of the cylinders, flow controls, pressure regulation or positioning.

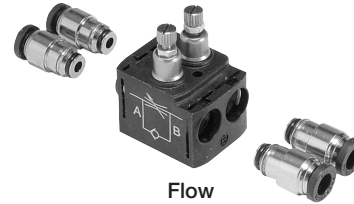

Flow Control



Pressure Regulator



Dual P.O. Check Valve



Vacuum Generator

D	Subbase & Manual Valves
H Series Micro	
Modulflex Series	
H Series ISO	
Network Connectivity	
DX ISOMAX Series	
Valvair-II Series	



For inventory, lead times, and kit lookup, visit www.pdnplu.com

Valve Function

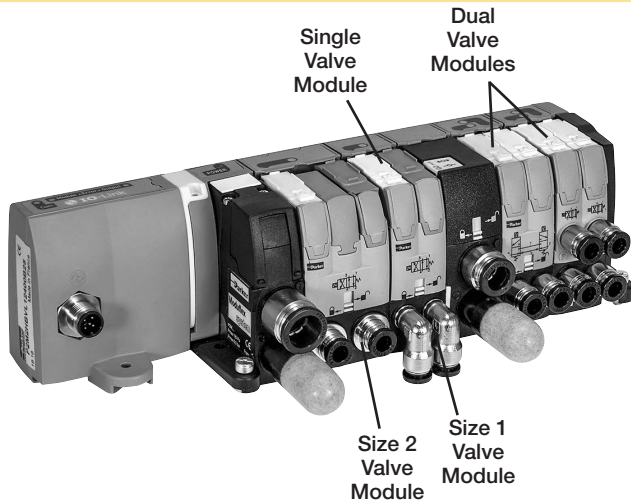

Modulflex Valve Islands offer the greatest flexibility for your design requirements.

Valve Modules are available as 4-Way or 3-Way valves and can be ordered as single or dual valves. A Single Valve Module has one valve in one valve body. A Dual Valve Module will have 2 valves in one valve body. Each Valve in the Dual Valve Body is controlled by a solenoid or air pilot and can be operated independently from the other valve in the same body. There are no dimensional difference between a single and a dual valve. Flow Rates are reduced on the dual valves.

Single valve modules offer Ceramic Slide Valve Technology while dual valve modules offer WCS – Wear Compensation System Technology. Both offer low friction shift forces, fast response and less spool wear.

Valve Modules are available in two different valve body sizes. Size 1 and Size 2 Valve Modules can be combined in both “T” and “V” Series Valve Islands without transition kits.

4/2, 4-Way, 2-Position Valves

Single Valves	ANSI Symbol	Description	Size 1 Body	Size 2 Body
		Single Solenoid, Spring Return Valve	Cv = .32	Cv = .80
		Single Air Pilot, Spring Return Valve		
		Double Solenoid Valve	Cv = .32	Cv = .80
		Double Air Pilot Valve		
Dual Valves	ANSI Symbol	Description	Size 1 Body	Size 2 Body
		(2) Single Solenoid, Spring Return Valve with Exhaust Check. Double Solenoid Valve Body	Cv = .18	N/A
		(2) Single Air Pilot, Spring Return Valve with Exhaust Check. Double Air Pilot Valve Body		

D

Subbase & Manual Valves

H Series Micro

Modulflex Series

H Series ISO

Network Connectivity

DX ISOMAX Series

Valvair II Series











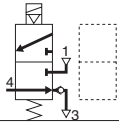

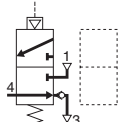
For inventory, lead times, and kit lookup, visit www.pdnplu.com

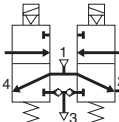
D31

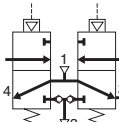
Parker Hannifin Corporation
 Pneumatic Division
 Richland, Michigan
www.parker.com/pneumatics

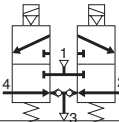
3/2, 3-Way, 2-Position Valves

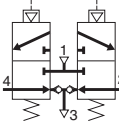
Single Valves	ANSI Symbol	Description	Size 1 Body	Size 2 Body
		Single Solenoid, NC, Spring Return Valve with Exhaust Check.	Cv = .22	Cv = .44
		Single Air Pilot, NC, Spring Return Valve with Exhaust Check.		
Dual Valves	ANSI Symbol	Description	Size 1 Body	Size 2 Body
		(2) Single Solenoid, NO, Spring Return Valve with Exhaust Check. Double Solenoid Valve Body	Cv = .22	Cv = .44
		(2) Single Air Pilot, NO, Spring Return Valve with Exhaust Check. Double Air Pilot Valve Body		
		(2) Single Solenoid, NC, Spring Return Valve with Exhaust Check. Double Solenoid Valve Body	Cv = .22	Cv = .44
		(2) Single Air Pilot, NC, Spring Return Valve with Exhaust Check. Double Air Pilot Valve Body		

Dual 3/2 Valves Replace All 3-Position Valves for a Better Performance

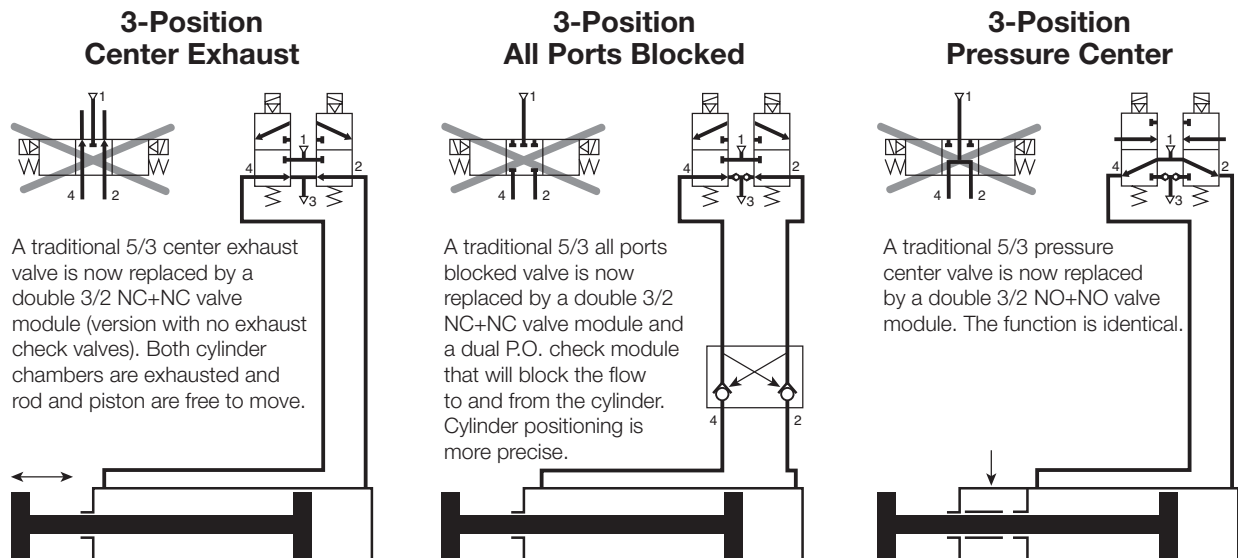











For inventory, lead times, and kit lookup, visit www.pdnplu.com

D32

Parker Hannifin Corporation
Pneumatic Division
Richland, Michigan
www.parker.com/pneumatics

D
 Subbase & Manifold Valves
 H Series Micro
 Moduflex Series
 H Series ISO
 Network Connectivity
 DX ISOMAX Series
 Valvair-II Series

"S" Series Individual Subbase Valves (Valve & Base without Pneumatic Connectors)

	Symbol	Type	Operator	Pilot connector	Cv	Part number	
						Size 1	Size 2
 Single Solenoid		4-way, 2-position	Single solenoid	M8 Lockable	0.32	P2M1S4ES2C	P2M2S4ES2C
				Clip		P2M1S4ES2CW	P2M2S4ES2CW
			Single air pilot			P2M1S4PS	P2M2S4PS
		4-way, 2-position	Double solenoid	M8 Lockable	0.32	P2M1S4EE2C	P2M2S4EE2C
				Clip		P2M1S4EE2CW	P2M2S4EE2CW
			Double air pilot			P2M1S4PP	P2M2S4PP
 Double Solenoid		3-way, 2-position, dual valve, NC/NC w/ exhaust check	Double solenoid	M8 Lockable	0.22	P2M1SDEE2C	P2M2SDEE2C
				Clip		P2M1SDEE2CW	P2M2SDEE2CW
			Double air pilot			P2M1SDPP	P2M2SDPP
		3-way, 2-position, dual valve, NO/NO w/ exhaust check	Double solenoid	M8 Lockable	0.22	P2M1SCEE2C	P2M2SCEE2C
				Clip		P2M1SCEE2CW	P2M2SCEE2CW
			Double air pilot			P2M1SCPP	P2M2SCPP
 Single Air Pilot		3-way, 2-position, dual valve, NC/NO w/ exhaust check	Double solenoid	M8 Lockable	0.22	P2M1SEEE2C	P2M2SEEE2C
				Clip		P2M1SEEE2CW	P2M2SEEE2CW
				3-way, 2-position, NC w/ exhaust check		Single solenoid	M8 Lockable
		Clip			P2M1S3ES2CW	P2M2S3ES2CW	
	Single air pilot				P2M1S3PS	P2M2S3PS	
		3-way, 2-position, dual valve, NC/NC	Double solenoid	M8 Lockable	0.22	P2M1SGEE2C	P2M2SGEE2C
			Clip	P2M1SGEE2CW		P2M2SGEE2CW	

Note: Includes 5/32" (4mm) Air Pilot Connectors.



M8 2-pin, male connector

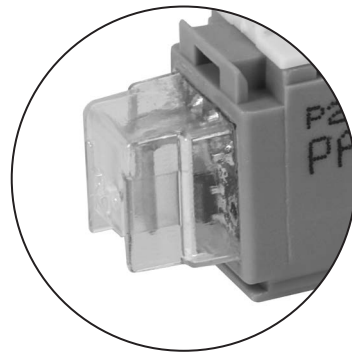

Clip Connector with LED & surge protection

 Most popular.



For inventory, lead times, and kit lookup, visit www.pdnplu.com

D33

Parker Hannifin Corporation
Pneumatic Division
Richland, Michigan
www.parker.com/pneumatics

D

Subbase & Manual Valves

H Series Micro

Moduflex Series

H Series ISO







Network Connectivity

DX ISOMAX Series

Valvair II Series

Part Numbers

"S" Series Accessories

Description	Tube Size (OD)	Option	Part Number	Part Number		
			Size 1	Size 2		
 <p>Push to connect fitting</p>	5/32"	Elbow	CMD04-1	—		
		Straight	FMD04-1	—		
	1/4"	Elbow	CMD07-1B	CMD07-2B		
		Straight	FMD07-1B	FMD07-2B		
	3/8"	Elbow	—	CMD09-2B		
		Straight	—	FMD09-2B		
	1/2"	Straight	—	FMD13-2B		
	6mm	Elbow	CMD06-1	CMD06-2		
		Straight	FMD06-1	FMD06-2		
	8mm	Elbow	—	CMD08-2		
		Straight	—	FMD08-2		
	10mm	Elbow	—	CMD10-2		
		Straight	—	FMD10-2		
	 <p>Muffler for exhaust port</p>			MMDVA1	MMDVA2	
 <p>Plug</p>			—	PMDYY2		
 <p>Double male union</p>		Connecting peripheral modules	HMDXX1	HMDXX2		
	 <p>M8 female connector to flying lead - IP67 LED and surge protection</p>	2m Cable	P8LS08L226C	P8LS08L226C		
		5m Cable	P8LS08L526C	P8LS08L526C		
9m Cable		P8LS08L926C	P8LS08L926C			
 <p>Clip connector – IP40</p>	1 x Clip connector	1 meter	P8LW021C	P8LW021C		
	Individual: including 2 flying leads		2 x Clip connector	1 meter	P8LW021C02	P8LW021C02
	Multiple: 1 common (0 VDC) and 1 flying lead per connector		4 x Clip connector	1 meter	P8LW021C04	P8LW021C04
			8 x Clip connector	1 meter	P8LW021C08	P8LW021C08
			M8 Connector	P8CS0803J	P8CS0803J	
 <p>Field wireable connector</p>			M12 Connector	P8CS1204J	P8CS1204J	

Note: 85 Durometer minimum for pneumatic connectors.

D
 Subbase & Manual Valves
 H Series Micro
 Moduflex Series
 H Series ISO
 Network Connectivity
 DX ISOMAX Series
 Valvair II Series

 Most popular.



For inventory, lead times, and kit lookup, visit www.pdnplu.com

"S" Series Individual Subbase Valve
(Complete with Pneumatic and Electrical Connectors)

	P2M	1	S	4ES	2C	00	A	F4
Basic Series								
Moduflex	P2M							
Size								
Size 1	1							
Size 2	2							
Valve Series								
Individual Subbase	S							
Valve Type / Function								
3-Way / 2-Position								
Single Solenoid, Nc Spring Return	3ES							
Single Air Pilot, Nc Spring Return	3PS							
4-Way / 2-Position								
Single Solenoid, Spring Return	4ES							
Single Air Pilot, Spring Return	4PS							
Double Solenoid	4EE							
Double Air Pilot	4PP							
Dual 3-Way, 2-Position, Spring Return								
Solenoid, NC / NC + PO Check (4/3 APB)	BEE*							
Air Pilot, NC / NC + PO Check (4/3 APB)	BPP*							
Solenoid, NO / NO (4/3 Pressure Ctr.)	CEE							
Air pilot NO / NO (4/3 Pressure Ctr.)	CPP							
Solenoid, NC / NC with Exhaust Check	DEE							
Air Pilot, NC / NC with Exhaust Check	DPP							
Solenoid, NO / NC with Exhaust Check	EEE							
Solenoid, NC / NC without Check (4/3 Exh. Ctr.)	GEE							
* Valve includes peripheral P. O. Check Valve and union fittings.								
Ports (all ports)								
C0*	10mm Elbow Fitting							
C4	5/32" (4mm) Elbow Fitting							
C6	6mm Elbow Fitting							
C7	1/4" Elbow Fitting							
C8*	8mm Elbow Fitting							
C9*	3/8" Elbow Fitting							
F0*	10mm Straight Fitting							
F3*	1/2" Straight Fitting							
F4	5/32" (4mm) Straight Fitting							
F6	6mm Straight Fitting							
F7	1/4" Straight Fitting							
F8*	8mm Straight Fitting							
F9*	3/8" Straight Fitting							
* Only available with size 2 valves.								
Fitting Configuration								
A*	Straight Fittings							
B*	Elbow Fittings							
C*†	Straight Fitting & Muffler							
D*†	Elbow Fitting & Muffler							
* Ports 1 & 3 fittings sizes are same as ports 2 & 4 (see example at left.)								
† Fitting in port 1, muffler in port 3.								
Operator Voltage								
24VDC	2C							
Remote Pilot - 5/32" (4mm) Tube	00							
LED / Cable								
00	No Cable, No LED, No Surge Suppression							
V2	2 Meter Cable with LED and Surge Suppression							
V5	5 Meter Cable with LED and Surge Suppression							
V9	9 Meter Cable with LED and Surge Suppression							
W0	No Cable / Clip Ready							
W1	1 Meter Cable, Clip Connector							

Example for fitting configuration:

Size 1

CF7 Ports 1 & 3
1/4" straight fitting & muffler

Ports 2 & 4
1/4" straight fittings

Size 2

AC0 Ports 1 & 3
10mm elbow fittings

Ports 2 & 4
10mm elbow fittings

Operator Voltage

24VDC	2C
Remote Pilot - 5/32" (4mm) Tube	00

Fitting Configuration

A*	Straight Fittings
B*	Elbow Fittings
C*†	Straight Fitting & Muffler
D*†	Elbow Fitting & Muffler

* Ports 1 & 3 fittings sizes are same as ports 2 & 4 (see example at left.)

† Fitting in port 1, muffler in port 3.

With only one universal solenoid pilot for all configurations

24VDC is now a global standard for all machines. The Moduflex 24VDC unique solenoid pilot is supplied with the multi-function manual override that can be adapted to all requirements, as explained by the drawings.

Multi-function adaptable manual override

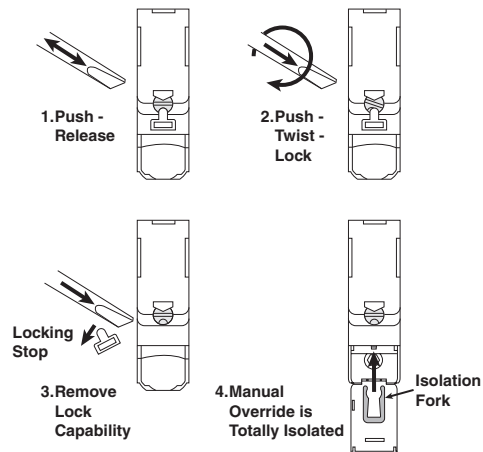

 Most popular.



For inventory, lead times, and kit lookup, visit www.pdnplu.com

D35

Parker Hannifin Corporation
 Pneumatic Division
 Richland, Michigan
www.parker.com/pneumatics

D

Subbase & Manual Valves

H Series Micro

Moduflex Series

H Series ISO

Network Connectivity

DX ISOMAX Series

Valvair II Series



Example:

Size 1, 4-Way Single Solenoid valve with 1/4" Straight Connectors in Ports 1, 2 and 4. Exhaust Muffler in Port 3. Valve to include 2m cable with LED and surge suppression.

“S” Series Single Solenoid

How to Order Complete Valve Assembly

Line Item	Quantity	Part Number	Description
1	1	P2M1S4ES2CV2CF7	Size 1, Individual Subbase Valve, 4 Way, Single Solenoid, 2m Cable with LED / Surge Suppression, Exhaust Muffler with 1/4" OD Straight Port Fittings

Notes:

1. Cables supplied loose with valve.
2. For LED and Surge Suppressor, cable must be supplied with valve.

How to Order Components











Line Item	Quantity	Part Number	Description
1	1	P2M1S4ES2C	Size 1, Individual Subbase Valve, Single Solenoid, 4 Way
2	1	P8LS08L226C	2m Cable with LED / Surge Suppression
3	3	FMD07-1B	Size 1, 1/4" OD Tube Push In Connector
4	1	MMDVA1	Size 1, Muffler for Exhaust Port

D
 Subbase & Manual Valves
 H Series Micro
 Moduflex Series
 H Series ISO
 Network Connectivity
 DX ISOMAX Series
 Valvair II Series

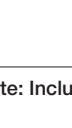

For inventory, lead times, and kit lookup, visit www.pdnplu.com

"T" Series Manifold Valves with Individual Connectors

	Symbol	Type	Operator	Pilot Connector	Cv	Part number	
						Size 1	Size 2
		4-way, 2-position	Single solenoid	M8 Lockable	0.32	P2M1T4ES2C	P2M2T4ES2C
			Clip			P2M1T4ES2CW	P2M2T4ES2CW
			Single air pilot		P2M1T4PS	P2M2T4PS	
		4-way, 2-position	Double solenoid	M8 Lockable	0.32	P2M1T4EE2C	P2M2T4EE2C
			Clip			P2M1T4EE2CW	P2M2T4EE2CW
			Double air pilot		P2M1T4PP	P2M2T4PP	
		4-way, 2-position, dual valve w/ exhaust check	Double solenoid	M8 Lockable	0.18	P2M1TJEE2C	—
			Clip			P2M1TJEE2CW	—
			Double air pilot		P2M1TJPP	—	
		3-way, 2-position, dual valve, NC/NC w/ exhaust check	Double solenoid	M8 Lockable	0.22	P2M1TDEE2C	P2M2TDEE2C
			Clip			P2M1TDEE2CW	P2M2TDEE2CW
			Double air pilot		P2M1TDPP	P2M2TDPP	
		3-way, 2-position, dual valve, NO/NO w/ exhaust check	Double solenoid	M8 Lockable	0.22	P2M1TC EE2C	P2M2TCEE2C
			Clip			P2M1TC EE2CW	P2M2TCEE2CW
			Double air pilot		P2M1TCPP	P2M2TCPP	
		3-way, 2-position, dual valve, NC/NO w/ exhaust check	Double solenoid	M8 Lockable	0.22	P2M1TEEE2C	P2M2TEEE2C
			Clip			P2M1TEEE2CW	P2M2TEEE2CW
			Double air pilot		P2M1TEPP	P2M2TEPP	
		3-way, 2-position, NC w/ exhaust check	Single solenoid	M8 Lockable	0.22	P2M1T3ES2C	P2M2T3ES2C
			Clip			P2M1T3ES2CW	P2M2T3ES2CW
			Single air pilot		P2M1T3PS	P2M2T3PS	
		3-way, 2-position, dual valve, NC/NC	Double solenoid	M8 Lockable	0.22	P2M1TGEE2C	P2M2TGEE2C
Clip				P2M1TGEE2CW		P2M2TGEE2CW	

Note: Includes 5/32" (4mm) Air Pilot Connectors.

Manifold Options

Module	Part Number
Pneumatic end plate kit	P2M2HXT01*
Pneumatic end plate kit with torx screwdriver	P2M2HXT0T*
Intermediate supply module (Includes 4 configuration plates)	P2M2BXT0A*

* Use Fittings for Size 2 Modules Only



P2M2HXT01

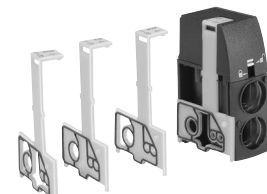

P2M2BXT0A



M8 2-pin, male connector

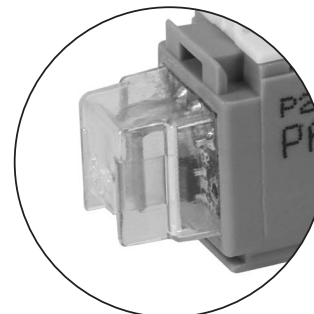

Clip Connector with LED & surge protection

 Most popular.



For inventory, lead times, and kit lookup, visit www.pdnplu.com

D37

Parker Hannifin Corporation
Pneumatic Division
Richland, Michigan
www.parker.com/pneumatics

D

Subbase & Manual Valves

H Series Micro

Moduflex Series

H Series ISO









Network Connectivity

DX ISOMAX Series

Valvair II Series

Part Numbers

"T" Series Size Accessories

Description	Tube size OD	Option	Part Number	Part Number
			Size 1	Size 2
 Push to connect fitting	5/32" or 4mm	Elbow	CMD04-1	—
		Straight	FMD04-1	—
	1/4"	Elbow	CMD07-1B	CMD07-2B
		Straight	FMD07-1B	FMD07-2B
	3/8"	Elbow	—	CMD09-2B
		Straight	—	FMD09-2B
	1/2"	Straight	—	FMD13-2B
	6mm	Elbow	CMD06-1	CMD06-2
		Straight	FMD06-1	FMD06-2
	8mm	Elbow	—	CMD08-2
		Straight	—	FMD08-2
	10mm	Elbow	—	CMD10-2
Straight		—	FMD10-2	
12mm	Elbow	—	CMD12-2 **	
	Straight	—	FMD12-2 **	
 Muffler for exhaust port			MMDVA1	MMDVA2
 Plug			PMDYY1	PMDYY2
 Double male union		Connecting peripheral modules	HMDXX1	HMDXX2
	 M8 female connector to flying lead - IP67 LED and surge protection	2M cable	P8LS08L226C	P8LS08L226C
		5M cable	P8LS08L526C	P8LS08L526C
9M cable		P8LS08L926C	P8LS08L926C	
 Clip connector – IP40 Individual: including 2 flying leads Multiple: 1 common (0 VDC) and 1 flying lead per connector	1 x Clip connector	1 meter	P8LW021C	P8LW021C
	2 x Clip connector	1 meter	P8LW021C02	P8LW021C02
	4 x Clip connector	1 meter	P8LW021C04	P8LW021C04
	8 x Clip connector	1 meter	P8LW021C08	P8LW021C08
 Field wireable connector		M8 connector	P8CS0803J	P8CS0803J
		M12 connector	P8CS1204J	P8CS1204J
 Torx screwdriver			P2M1K0TASD	P2M1K0TASD

Note: 85 Durometer minimum for pneumatic connectors.

** 12mm OD fittings can not be used with valves. 12mm OD fittings can only be used in pneumatic end plate kit and intermediate air supply module.

D

Subbase & Manual Valves

H Series Micro

Moduflex Series

H Series ISO

Network Connectivity

DX ISOMAX Series

Valvair-II Series

 Most popular.



For inventory, lead times, and kit lookup, visit www.pdnplu.com

Ordering Information

"T" Series Valve Manifold with Individual Connectors
(Complete with Pneumatic and Electrical Connectors)

P2M 1 T 4ES 2C 00 0 F4

Basic Series	Valvetronic Modules	P2M
Size	Size 1	1
Size	Size 2	2
Valve Series	Individual Wire	
Valve Series	T	
Valve Type / Function		
<i>3-Way / 2-Position</i>		
Single Solenoid, NC Spring Return	3ES	
Single Air Pilot, NC Spring Return	3PS	
<i>4-Way / 2-Position</i>		
Single Solenoid, Spring Return	4es	
Single Air Pilot, Spring Return	4ps	
Double Solenoid	4ee	
Double Air Pilot	4pp	
<i>Dual 3-Way, 2-Position, Spring Return</i>		
Solenoid, NC / NC + PO Check (4/3 APB)	BEE*	
Air Pilot, NC / NC + PO Check (4/3 APB)	BPP*	
Solenoid, NO / NO (4/3 Pressure Ctr.)	CEE	
Air Pilot NO / NO (4/3 Pressure Ctr.)	CPP	
Solenoid, NC / NC with Exhaust Check	DEE	
Air Pilot, NC / NC with Exhaust Check	DPP	
Solenoid, NO / NC with Exhaust Check	EEE	
Solenoid, NC / NC without Check (4/3 Exh. Ctr.)	GEE	
<i>Dual 4-Way, 2-Position, Spring Return</i>		
Solenoid	JEE**	
Air Pilot	JPP**	

* Valve includes peripheral P.O. check valve and union fittings.
** Size 1 only.

Ports 2 & 4	
C0*	10mm Elbow Fitting
C4	5/32" (4mm) Elbow Fitting
C6	6mm Elbow Fitting
C7	1/4" Elbow Fitting
C8*	8mm Elbow Fitting
C9*	3/8" Elbow Fitting
F0*	10mm Straight Fitting
F3*	1/2" Straight Fitting
F4	5/32" (4mm) Straight Fitting
F6	6mm Straight Fitting
F7	1/4" Straight Fitting
F8*	8mm Straight Fitting
F9*	3/8" Straight Fitting

* Only available with size 2 valves.

Ports 1 & 3	
0	None

LED / Cable	
00	No Cable, no LED, no Surge Suppression
V2	2 Meter Cable with LED and Surge Suppression
V5	5 Meter Cable with LED and Surge Suppression
V9	9 Meter Cable with LED and Surge Suppression
W0	No Cable / Clip Ready
W1	1 Meter Cable, Clip Connector

Operator Voltage	
2C	24VDC
00	Remote Pilot - 5/32" (4mm) Tube

With only one universal solenoid pilot for all configurations

24VDC is now a global standard for all machines. The Moduflex 24VDC unique solenoid pilot is supplied with the multi-function manual override that can be adapted to all requirements, as explained by the drawings.

Multi-function adaptable manual override

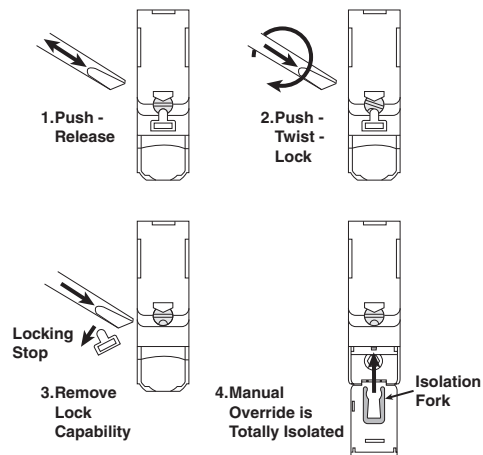

 Most popular.



For inventory, lead times, and kit lookup, visit www.pdnplu.com

D39

Parker Hannifin Corporation
Pneumatic Division
Richland, Michigan
www.parker.com/pneumatics

D

Subbase & Manual Valves

H Series Micro

Moduflex Series

H Series ISO

Network Connectivity

DX ISOMAX Series

Valvair II Series

Ordering Information

Subbase & Manifold Valve Products Moduflex "T" Series



Example:

Size 1, 4-Way Single Solenoid valve with 1/4" Straight Connectors in Ports 2 and 4. Valve to include 2m cable with LED and surge suppression.

"T" Series Single Solenoid

How to Order Complete Valve Assembly

Line Item	Quantity	Part Number	Description
1	1	P2M1T4ES2CV20F7	Size 1, T Series Manifold Valves, 4 Way, Single Solenoid, 2m Cable with LED / Surge Suppression, 1/4" OD Straight Port Fittings

Notes:

1. Cables supplied loose with valve.
2. For LED and Surge Suppressor, cable must be supplied with valve.
3. To assemble into a manifold, Pneumatic Head and Tail Set must be ordered separately.

How to Order Components

Line Item	Quantity	Part Number	Description
1	1	P2M1T4ES2C	Size 1, T Series Manifold Valves, Single Solenoid, 4 Way
2	1	P8LS08L226C	2m Cable with LED / Surge Suppression
3	2	FMD07-1B	Size 1, 1/4" OD Tube Push In Connector

D

Subbase & Manual Valves

H Series Micro

Moduflex Series

H Series ISO

Network Connectivity











DX ISOMAX Series

Valvair II Series



For inventory, lead times, and kit lookup, visit www.pdnplu.com

"V" Series Manifold Valves with Collective Wiring

	Symbol	Type	Operator	Cv	Part Number	
					Size 1	Size 2
 <p>Single Solenoid</p>		4-way, 2-position	Single solenoid	0.32	P2M1V4ES2CV	0.8 P2M2V4ES2CV
		4-way, 2-position	Double solenoid	0.32	P2M1V4EE2CV	0.8 P2M2V4EE2CV
		4-way, 2-position, dual valve, w/ exhaust check	Double solenoid	0.18	P2M1VJEE2CV	
		3-way, 2-position, dual valve, NC/NC w/ exhaust check	Double solenoid	0.22	P2M1VDEE2CV	0.44 P2M2VDEE2CV
 <p>Double Solenoid</p>		3-way, 2-position, dual valve, NO/NO w/ exhaust check	Double solenoid	0.22	P2M1VCEE2CV	0.44 P2M2VCEE2CV
		3-way, 2-position, dual valve, NC/NO w/ exhaust check	Double solenoid	0.22	P2M1VEEE2CV	0.44 P2M2VEEE2CV
		3-way, 2-position, NC w/ exhaust check	Single solenoid	0.22	P2M1V3ES2CV	0.44 P2M2V3ES2CV
		3-way, 2-position, dual valve, NC/NC	Double solenoid	0.22	P2M1VGEE2CV	0.44 P2M2VGEE2CV

 Most popular.



For inventory, lead times, and kit lookup, visit www.pdnplu.com

"V" Series Accessories

	Description	Tube size OD	Option	Part Number	
				Size 1	Size 2
	Push to connect fitting	5/32"	Elbow	CMD04-1	—
			Straight	FMD04-1	—
		1/4"	Elbow	CMD07-1B	CMD07-2B
			Straight	FMD07-1B	FMD07-2B
		3/8"	Elbow	—	CMD09-2B
			Straight	—	FMD09-2B
		1/2"	Straight	—	FMD13-2B
			6mm	Elbow	CMD06-1
		8mm	Straight	FMD06-1	FMD06-2
			Elbow	—	CMD08-2
		10mm	Straight	—	FMD08-2
			Elbow	—	CMD10-2
		12mm	Straight	—	FMD10-2
			Elbow	—	CMD12-2 **
			Straight	—	FMD12-2 **
	Muffler for exhaust port		—	MMDVA1	MMDVA2
	Plug		—	PMDYY1	PMDYY2
	Double male union		Connecting peripheral modules	HMDXX1	HMDXX2
	Electrical 20-pin multi-connector cable with flying leads	IP65 rated	2M cable	P8LMH20M2A	P8LMH20M2A
			5M cable	P8LMH20M5A	P8LMH20M5A
			9M cable	P8LMH20M9A	P8LMH20M9A
	Electrical 25-pin D-sub cable	IP20 rated	3M cable	P8LMH25M3A	P8LMH25M3A
			9M cable	SCD259D	SCD259D
			IP65 rated	3M cable	SCD253W
			9M cable	SCD259WE	SCD259WE
	Field wireable connector for power supply	Female	M12 - A code	P8CS1205AA	
	Power & Communication Cable	IO-Link	5-pin male to female cable, TPE	RKC 4.5T*-RSC 4.5T/S1587	
	Torx screwdriver		—	P2M1K0TASD	P2M1K0TASD

Where * = 1, 2, 3, 4, 5, 10, 20 meter standard lengths

Note: 85 Durometer minimum for pneumatic connectors.

** 12mm OD fittings can not be used with valves. 12mm OD fittings can only be used in pneumatic end plate kit and intermediate air supply module.

D

Subbase & Manual Valves

H Series Micro

Moduflex Series

H Series ISO

Network Connectivity

DX ISOMAX Series

Valvair II Series



For inventory, lead times, and kit lookup, visit www.pdnplu.com

Electrical Connections

Description	Part Number
20-pin, Multi-connector electrical head module	P2M2HEV0A
25-pin, D-sub, electrical head module	P2M2HEV0D



P2M2HEV0A



P2M2HEV0D

Network Connectivity Connections

Description	Part Number	
EtherNet I/P	P2M2HBVE12400	
PROFINET	P2M2HBVN12400	
EtherCAT	P2M2HBVT12400	
Modbus TCP	P2M2HBVM12400	
PowerLink	P2M2HBVW12400	
IO-Link Class A	3-Pin, Aux power 1 & 3	P2M2HBVL12400A13
IO-Link Class A	3-Pin, Aux power 4 & 3	P2M2HBVL12400A43
IO-Link Class A	3-Pin, Aux power 4 & 2	P2M2HBVL12400A42
IO-Link Class B	5-Pin, Aux power 2 & 5	P2M2HBVL12400B25

Manifold Options

Module	Part Number
Pneumatic end plate kit	P2M2HXT01*
Pneumatic end plate kit with torx screwdriver	P2M2HXT0T*
Intermediate supply module (Includes 4 configuration plates)	P2M2BXV0A*

* Use Fittings for Size 2 Modules Only



P2M2HXT01

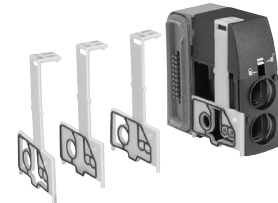

P2M2BXV0A

Most popular.



For inventory, lead times, and kit lookup, visit www.pdnplu.com

Ordering Information

"V" Series Valve Manifold with Collective Wiring
(Complete with Pneumatic Connectors)

P2M 1 V 4ES 2C V0 0 F4

Basic Series	
Valvetronic Modules	P2M

Size	
Size 1	1
Size 2	2

Valve Series	
Collective Wiring	V

Valve Type / Function	
3-Way / 2-Position	
Single Solenoid, NC Spring Return	3ES
4-Way / 2-Position	
Single Solenoid, Spring Return	4es
Double Solenoid	4ee
Dual 3-Way, 2-Position, Spring Return	
Solenoid, NC / NC + PD Check (4/3 APB)	BEE*
Solenoid, NO / NO (4/3 Pressure Ctr.)	CEE
Solenoid, NC / NC with Exhaust Check	DEE
Solenoid, NO / NC with Exhaust Check	EEE
Solenoid, NC / NC without Check (4/3 Exh. Ctr.)	GEE
Dual 4-Way, 2-Position, Spring Return	
Solenoid	JEE**

* Valve includes peripheral P. O. Check valve and union fittings.
** Size 1 Only.

Ports 2 & 4	
C0*	10mm Elbow Fitting
C4	5/32" (4mm) Elbow Fitting
C6	6mm Elbow Fitting
C7	1/4" Elbow Fitting
C8*	8mm Elbow Fitting
C9*	3/8" Elbow Fitting
F0*	10mm Straight Fitting
F3*	1/2" Straight Fitting
F4	5/32" (4mm) Straight Fitting
F6	6mm Straight Fitting
F7	1/4" Straight Fitting
F8*	8mm Straight Fitting
F9*	3/8" Straight Fitting

* Only available with size 2 valves.

Ports 1 & 3	
0	None

LED / Cable	
V0	No Cable with LED and Surge Suppression

Operator Voltage	
2C	24VDC

D
 Subbase & Manual Valves
 H Series Micro
 Moduflex Series
 H Series ISO
 Network Connectivity
 DX ISOMAX Series
 Valvair II Series

With only one universal solenoid pilot for all configurations

24VDC is now a global standard for all machines. The Moduflex 24VDC unique solenoid pilot is supplied with the multi-function manual override that can be adapted to all requirements, as explained by the drawings.

Multi-function adaptable manual override

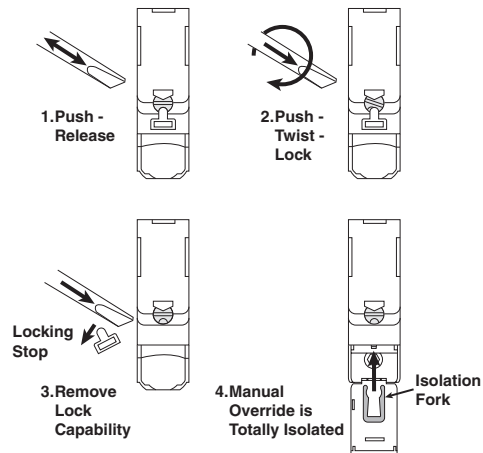

Most popular.



For inventory, lead times, and kit lookup, visit www.pdnplu.com

"V" Series Single Solenoid



How to Order -

Example: Size 1, 4-Way Single Solenoid valve with 1/4" Straight Connectors in Ports 2 and 4. Valve to include LED and surge suppression.

Line Item	Quantity	Part number	Description
Complete Peripheral Module			
1	1	P2M2V4ES2CV00F7	Size 1, V Series Manifold Valves, 4 Way, Single Solenoid, LED / Surge Suppression, 1/4" OD Straight Port Fittings
Components			
1	1	P2M1V4ES2CV	Size 1, V Series Manifold Valves, Single Solenoid, 4 Way
2	2	FMD07-1B	Size 1, 1/4" OD Tube Push In Connector

D

Subbase & Manual Valves

H Series Micro

Moduflex Series

H Series ISO

Network Connectivity

DX ISOMAX Series

Valvair II Series



For inventory, lead times, and kit lookup, visit www.pdnplu.com

D45

Parker Hannifin Corporation
 Pneumatic Division
 Richland, Michigan
www.parker.com/pneumatics

"V" Series 25-Pin, D-Sub Addressing



Valve Island Head 25-Pin, Multi-Connector

On the island head module, the multi-connector integrates the HE10 connector standard in its 25-Pin version.

Its plug-in function is secured in position with a guillotine lock with easy access from the front of the island.

The 25-Pin, D-Sub multi-connector is rated for IP40.

25-Pin, Multi-Connector Addressing

When assembling a **V Series** island, modules are automatically connected to the head module through the modular principle of the integrated electrical connections.

Each wire color code corresponds a solenoid pilot position in the island.



P8LMH25M3A - Cable

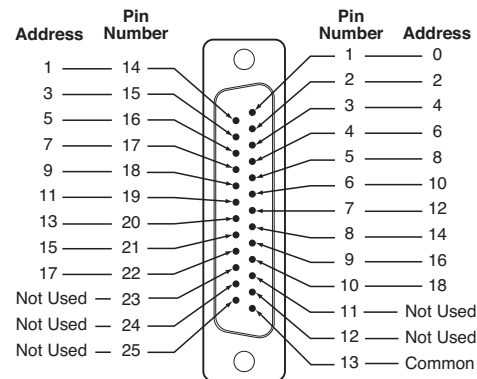

Face View - Male D-Sub, 25-Pin Head Module Connector

Electrical 25-Pin D-Sub Cable

Length (meters)	Weight (oz)	IP	Part Number
3	14.3	20	P8LMH25M3A
3	14.3	65	SCD253W
9	55.8	20	SCD259D
9	55.8	65	SCD259WE

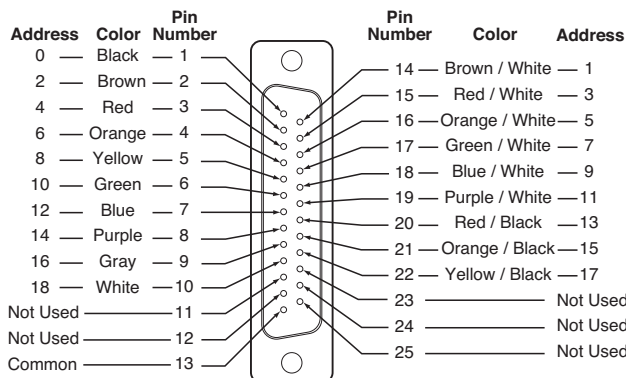

Face View - Female D-Sub, 25-Pin Cable Connector

Electrical Specifications

Rated voltage	24VDC
Maximum addresses	19
Maximum energized simultaneously	19
Electrical connection	25-Pin, D-Sub DIN41652, MIL-C-24308, NFC93425 Type HE5
Polarity	Insensitive: PNP and NPN compatible
Dust and water protection	IP40 / IP65

D
 Subbase & Manual Valves
 H Series Micro
 Moduflex Series
 H Series ISO
 Network Connectivity
 DX ISOMAX Series
 Valvair II Series



For inventory, lead times, and kit lookup, visit www.pdnplu.com

"V" Series 20-Pin, Multi-Connector and Addressing



Valve Island Head 20-Pin, Multi-Connector

On the island head module, the multi-connector integrates the HE10 connector standard in its 20-Pin version.

Its plug-in function is secured in position with a guillotine lock with easy access from the front of the island.

Just like the whole island, the multi-connector follows the IP65 protection standard.

Cable Specification:

8.6 mm dia., UL, 20 wires, 0.22mm², AWG 24

Minimum Static Radius: 6.5 mm (.255")

Available with 6.56 ft. (2 m), 16.4 ft. (5 m) and 29.5 ft. (9 m) lengths.



P8LMH20M2A - Cable

Electrical 20-Pin Multi-Connector with Flying Lead Cable

Cable Length	Weight (oz)	IP	Part Number
2 m	10.97	65	P8LMH20M2A
5 m	27.41	65	P8LMH20M5A
9 m	49.38	65	P8LMH20M9A

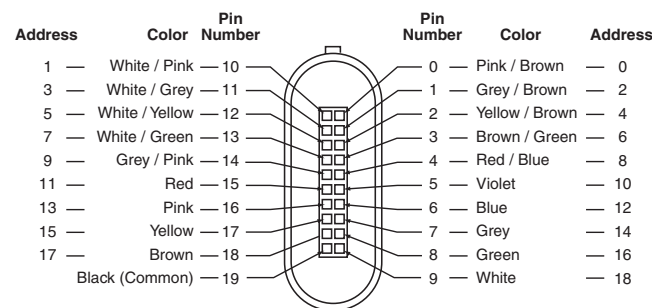

Face View - Female 20-Pin Cable Connector

20-Pin, Multi-Connector Addressing

When assembling a **V Series** island, modules are automatically connected to the head module through the modular principle of the integrated electrical connections.

The color code addressing given below conforms to the DIN 47100 standard.

Each wire color code corresponds a solenoid pilot position in the island.

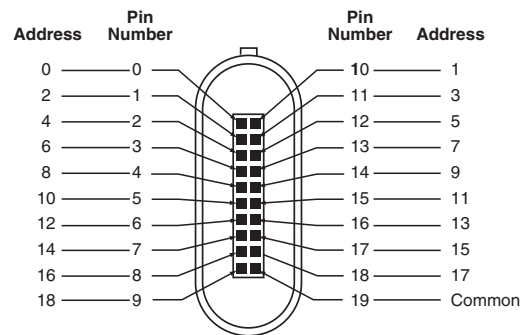

Face View - Male 20-Pin Head Module Connector

Electrical Specifications

Rated Voltage	24VDC
Maximum Addresses	19
Maximum Energized Simultaneously	19
Electrical Connection	Type HE10
Polarity	Insensitive: PNP and NPN compatible
Dust and Water Protection	IP65

P2M Network Nodes

P2M communication modules directly attach to the Moduflex valve series as well as the P2M endplates of the H Series Micro and H Series ISO valve products. It offers a compact and low cost network solution.

Features

- Small, compact product design
- IO-Link Class A & Class B nodes
- Broad protocol offering
- Channel-level diagnostics (LED and Electronic)
- Horizontal and vertical mounting without derating
- 5g vibration
- Quick-disconnects for I/O and network connectivity
- Built-in panel grounding
- CE certification



D
Subbase & Manual Valves
H Series Micro
Moduflex Series
H Series ISO
Network Connectivity
DX ISOMAX Series
Valvair-II Series



For inventory, lead times, and kit lookup, visit www.pdnplu.com

P2M Industrial Ethernet Node

The P2M Industrial Ethernet 24 DO node allows a very simple and cost efficient connection to the most popular Industrial Ethernet networks.

Designed with isolated auxiliary power, it can easily be adapted to all power supply architectures and follow any required machine directives as Safe Power Capable.



Industrial Ethernet Protocol	Part Number
EtherNet/IP (Safe Power Capable)	P2M2HBVE12400
PROFINET (Safe Power Capable)	P2M2HBVN12400
EtherCAT (Safe Power Capable)	P2M2HBVT12400
Modbus/TCP (Safe Power Capable)	P2M2HBVM12400
PowerLink (Safe Power Capable)	P2M2HBVW12400

Simple Product Set-Up

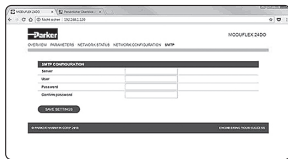

The P2M Industrial Ethernet node offers IP addressing through 3 rotary switches located on the top side.

The 3 rotary switches also allow for Factory Reset, IP address storage, and DHCP addressing.

If supported by the protocol used, the IP address can be modified through the embedded web page.

For an application requiring a regular disconnection / reconnection of communication & power, PROFINET and EtherNet/IP protocols allow respectively a Fast Start-Up (FSU) and Quick Connect mode. This mode can be enabled or disabled.

Topology / Integrated Ethernet Switch

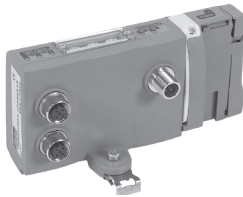

The P2M Industrial Ethernet 24 DO node offers 2 Ethernet ports allowing a line topology without external switch. The Ring topology can also be supported (enable/disable) for PROFINET, EtherNet/IP and Modbus TCP/IP.

The integrated Ethernet switch supports Class C services allowing use in an isochronous real time (IRT) structure.

Easy Diagnostics – Local LEDs, Process (cyclic) data, Parameter (acyclic) data

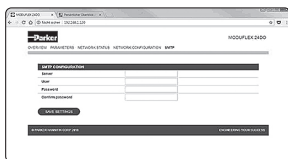

The P2M Industrial Ethernet 24 DO node offers local diagnostics through 7 LED's located on the visible top side, showing:

- Logic status
- Ethernet activity on both ports
- Standard Status due to protocol
- Output error / Auxiliary power

This local information as well as configuration and predictive maintenance diagnostics (Power monitoring, Solenoid cycle counting, etc) are available via both Process Data (cyclic) and Parameter Data (acyclic) via the PLC through the network and also easily viewable from the embedded web page.

When the PLC is NOT in control, the web page allows the user to force ON/OFF the solenoids state. This function has password protection.

P2M Industrial Ethernet Connections & Configuration

Ethernet ports and Auxiliary power connection

Ethernet ports: 2 x Standard Female M12 D-Coded – 5 pins
 Auxiliary Power: Standard Male M12 A-Coded – 4 pins

Configuration file

The configuration files (.EDS, .GDS, etc) can be download from the product web page.

Add on Instructions & Function Blocks

Add on Instructions & Function Blocks to assist in the configuration and programming of the P2M Node are available on the product web page – www.parker.com/pdn/P2M_IE

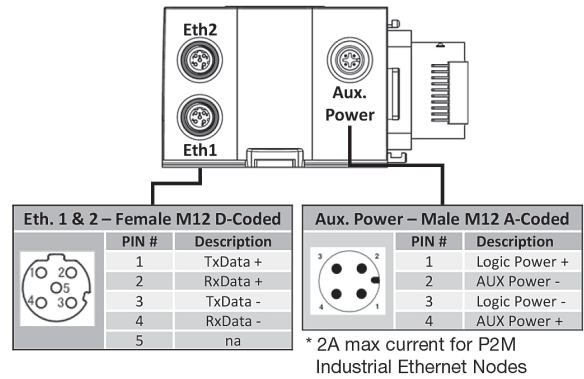

Safe Power Capable

Auxiliary power of P2M Industrial Ethernet 24 DO node can be supplied from a safe output device following machinery directives. This includes:

- Output Signal Switch Device (OSSD) test pulse compatible
- Galvanic isolation between 0 Vdc Logic and Auxiliary power
- PP or PM cabling modes

For more details, refer to the user manuals located at www.parker.com/pdn/P2M_IE

P2M Industrial Ethernet Valve Control

All P2M Industrial Ethernet Nodes can easily connect to and control pneumatic valves sizes ranging from 0.18 Cv to 6.0 Cv utilizing the Moduflex, H Micro, or H ISO valve series including the new H ISO Universal manifold which can mix ISO sizes 15407 (sizes 02 & 01) and 5599 (sizes 1 & 2) without transition plates.

P2M on Moduflex

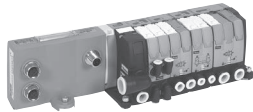

P2M on H Series Micro

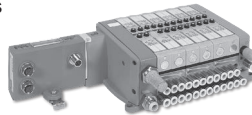

P2M on H Series ISO Universal

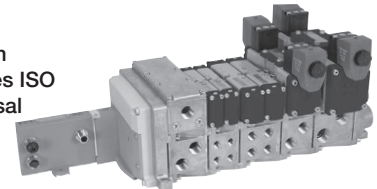

P2M Industrial Ethernet Node Output (Solenoid) data mapping - shown on Moduflex valve series

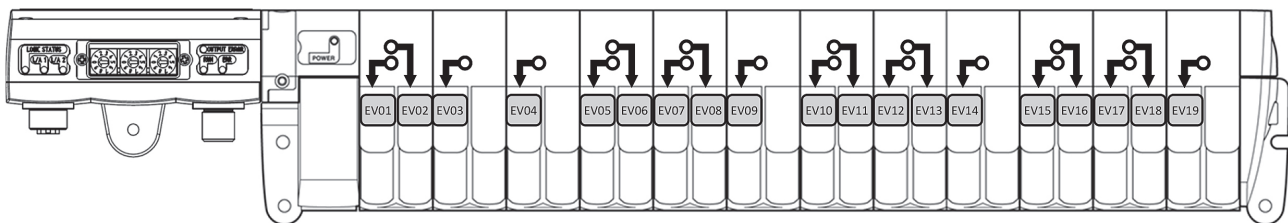

	7 3	2 0
Byte 0	EV08	EV01
Byte 1	EV16	EV09
Byte 2*	EV24 EV20	EV19 EV17

* Byte 2 / Bits 3 to 7 are only available when connected to H Series Micro or H Series ISO valve manifolds. The Moduflex valve series is limited to 19.

Process (Cyclic) Diagnostic through network via ADI #9 – “Module Error Input”

Easy to access diagnostic data transmitted to the PLC as Application Device Instance (ADI) #9

- Voltage warning, short circuit condition, module error, etc
- For more details refer to user manual on product web page – www.parker.com/pdn/P2M_IE

ADI	Instance name	Data type	Access
#9	Module error input	Unit 16	Read

Byte 0	Diag 7 Diag 0
Byte 1	Reserved

D
 Subbase & Manual Valves
 H Series Micro
 Moduflex Series
 H Series ISO
 Network Connectivity
 DX ISOMAX Series
 Valvair II Series



For inventory, lead times, and kit lookup, visit www.pdnplu.com

Valve Island V Series with Industrial Ethernet connection

EtherNet/IP™

EtherCAT®

The P2M Industrial Ethernet Lite node 24DO allows a very simple and cost efficient connection to the most popular Industrial Ethernet networks.

In its compact IP40 version equipped with two RJ45 Ethernet ports, it saves size in cabinet applications and offers an easy connection to the network in a line topology.

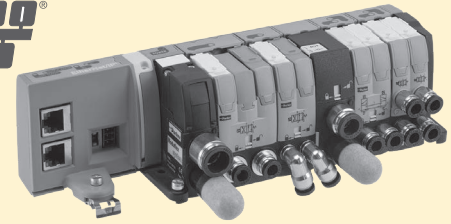

Industrial Ethernet Protocol	Part Number
Profinet IO	P2M2HBVE12400RJ
EtherNet/IP	P2M2HBVN12400RJ
EtherCAT	P2M2HBVT12400RJ

Product Set-Up

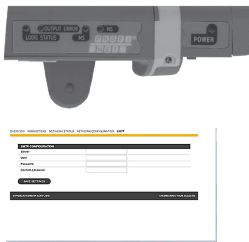

The P2M Lite Node 24DO is by default in DHCP mode. The module must be assigned to a static IP-Address in order to be controlled via the network.

The Network Configuration settings can be done through the embedded web server of the node as well as "IPconfig", "TIA Portal" or similar methods.

For an application requiring a regular disconnection / reconnection of the node, Profinet and EtherNet/IP protocols allow respectively a Fast Start-Up (FSU) and Quick Connect mode. This mode can be enable or disable.

Technology / Integrated Ethernet Switch



The P2M Industrial Ethernet Lite node 24DO offers 2 RJ45 ports allowing a line topology without external switch. The Ring topology can also be supported (enable/disable) for Profinet and EtherNet/IP.

The integrated Ethernet switch support Class C Services allowing used in an isochronous real time (IRT) structure.

Diagnostic

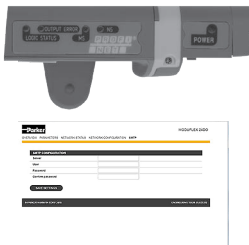

The P2M Industrial Ethernet Lite node 24DO offers a local diagnostic through 5 LED's located on the visible top side and 4 additional on both Ethernet connectors showing:

- Logic status
- Ethernet activity on both ports
- Standard Status due to protocol
- Output error / Power Supply

This local information as well as trouble shooting and predictive maintenance diagnostics (Power monitoring, Life cycle counting, ...) are available in PLC through the network and reported on imbedded web page.

When PLC is in "STOP", the web page allows to force ON/OFF solenoids state. This function has a password protection.

Save 1.31 inches with P2M Lite Node compared to P2M Ethernet Node

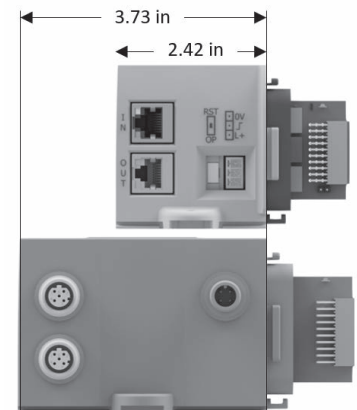

For inventory, lead times, and kit lookup, visit www.pdnplu.com

D51

Parker Hannifin Corporation
 Pneumatic Division
 Richland, Michigan
www.parker.com/pneumatics

D

Subbase & Manual Valves

H Series Micro

Modulflex Series

H Series ISO

Network Connectivity

DX ISOMAX Series

Valvair II Series

Industrial Ethernet Lite Node Connections and Diagnostic Functions

Ethernet and Power Connections

Network Communication Ports:

2 x Standard RJ45 Female connectors

Usage of standard manufactured cables available from your usual electrical supplier is recommended.

Power Supply:

Standard 3-Pin Male Connector - 3,81 mm pitch

Working mode selector:

DIP-switch

Configuration Files

The configuration files can be download from the product web page: www.parker.com/pde/P2M_IE

IP Address Setting

For both Profinet IO and EtherNet/IP protocols, the P2M Lite 24DO Node is by default in DHCP mode. The module must be assigned to a static IP-Address in order to be controlled via network. Please, refer to the user manual for IP-Address assignment process.

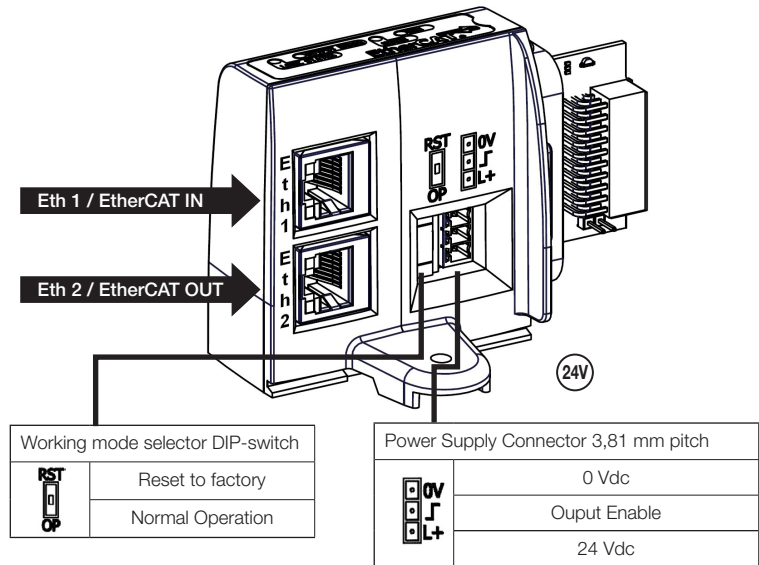

Local and Network Diagnostic Functions

Local Diagnostic

The P2M Lite 24DO node offers a local diagnostic via 9 LED's. Please refer to user manual with interpretation table.

Network Diagnostic

The P2M Lite 24DO Node offers additional useful module status information:

- Pilot overload or short circuit
- Power Voltage out of tolerance
- Cycle counter for every pilot
- Module temperature

For detailed technical information on the P2M Lite 24DO Node and a complete interpretation of node's diagnostic functionalities, please refer to the User Manual available from the product web page: www.parker.com/pde/P2M_IE

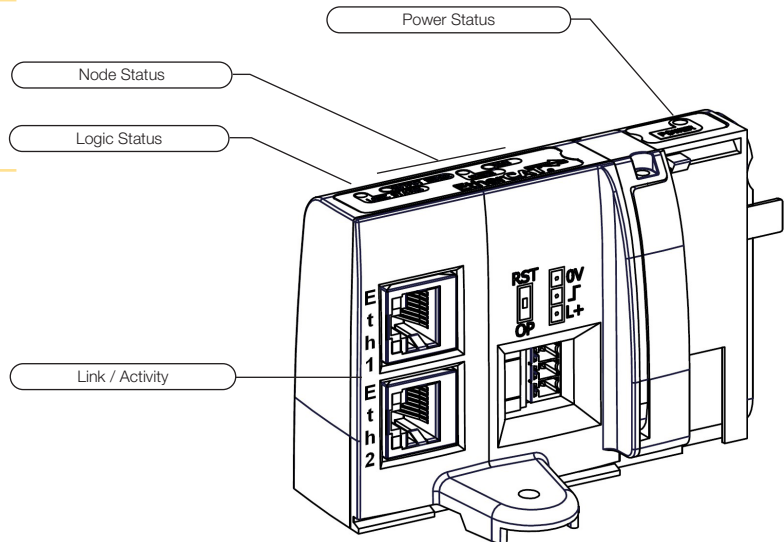

EtherNet/IP™



EtherCAT®

D
 Subbase & Manifold Valves
 H Series Micro
 Modulflex Series
 H Series ISO
 Network Connectivity
 DX ISOMAX Series
 Valvair II Series



For inventory, lead times, and kit lookup, visit www.pdnplu.com

Valve Island V Series with IO-Link connection

The P2M Moduflex IO-Link 24 DO node allows a very simple and cost efficient connection to any IO-Link master, centralised into the PLC or decentralised through an industrial Ethernet network.

Designed in both Class A and Class B versions with an isolated auxiliary power, it can easily be adapted to all power supply architectures and follow machine directives.

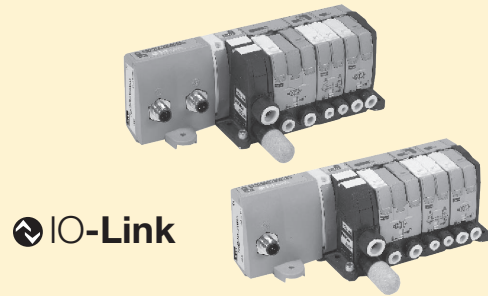

“V” Series Valve Island - P2M head module for IO-Link

Electrical Module for 24 outputs
 (The last 5 outputs of this 24 DO module can not be used with Moduflex Valve)



M12 A coded Connector connection

Description	IO-Link class	IO-Link	Aux. power	Aux. power pinout	Weight (g)	Part number	
						Standard	Safe power capable
Class A P2M IO-Link communication module	Class A	3 Pin's	3 Pin's	1 & 3	160	P2M2HBVL12400A13	P2M2HBVL12400A13-SPC
		3 Pin's	3 Pin's	4 & 3	160	P2M2HBVL12400A43	P2M2HBVL12400A43-SPC
		3 Pin's	5 Pin's	4 & 2	160	P2M2HBVL12400A42	P2M2HBVL12400A42-SPC
Class B	Class B	5 Pin's		2 & 5	140	P2M2HBVL12400B25	P2M2HBVL12400B25-SPC
Power & communication cable						RKC 4.5T*-RSC 4.5T/S1587	

IODD file can be downloaded from IODD Finder or the Moduflex web site:
<https://ioddfinder.io-link.com> or www.parker.com/pdn/io-link

Where * = 1, 2, 3, 4, 5, 10, 20 meter standard lengths

P2M Class A Module with Independent Auxiliary Power Supply

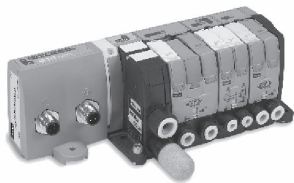

The P2M IO-Link Class A module can handle a Moduflex valve manifold having up to 19 solenoid outputs, or H Series Micro / ISO up to 24 solenoid outputs.

Thanks to its 2 x M12 A coded male connectors, the P2M node can be connected to any IO-Link Class A master and separately receive its auxiliary power supply for valves from an independent source.

The P2M IO-Link Class A module exists in 3 versions with the auxiliary power M12 connector pin out adapted to any sourcing through a standard M12 cable:

- P2M2HBVL12400A13 version: 24VDC / 0VDC on pins 1 & 3 – Standard version
- P2M2HBVL12400A43 version: 24VDC / 0VDC on pins 4 & 3 – Compatible with Siemens wiring
- P2M2HBVL12400A42 version: 24VDC / 0VDC on pins 4 & 2 – Compatible with Rockwell wiring and Turck wiring

P2M Class B Module

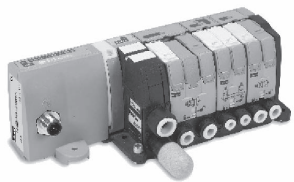

The P2M IO-Link Class B module can handle a Moduflex valve manifold having up to 19 solenoid outputs, or H Series Micro / ISO up to 24 solenoid outputs.

Thanks to its single M12 A coded male connectors, P2M node can be connected to any IO-Link Class B master receiving its auxiliary power supply for valves on pins 2 & 5 from the only cable simplifying the connection.

- P2M2HBVL12400B25 version: 24VDC / 0VDC on pins 2 & 5

Valve Series

Check the total maximum solenoid current consumption against the limit of the power supply and P2M module (standard version 4A, SPC version 2A).



Moduflex Valve
 Cv: .18 - 0.80
 19 Solenoids
 42mA per Sol.

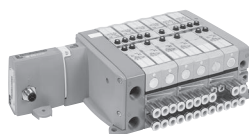

H Micro
 Cv: 0.35
 24 Solenoids
 42mA per Sol.

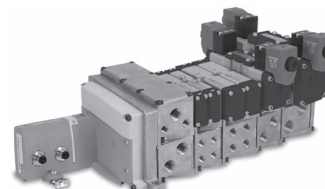

H ISO 15407-2 & 5599-2
 Cv: 0.55 - 6.0
 24 Solenoids
 42mA (15407) / 133mA (5599) per Sol.



For inventory, lead times, and kit lookup, visit www.pdnplu.com

IO-Link Module Connection and Diagnostic Functions



IO-Link Module Connection

Standard male M12 – type A

Usage of standard manufactured cables available from your usual electrical supplier is recommended.

Note: Auxiliary power for solenoids can be wired allowing the user to turn outputs off while the communications remains on.

Configuration

IODD file can be downloaded from IODD Finder or the P2M web site:
<https://ioddfinder.io-link.com>
www.parker.com/pdn/P2M_IOL

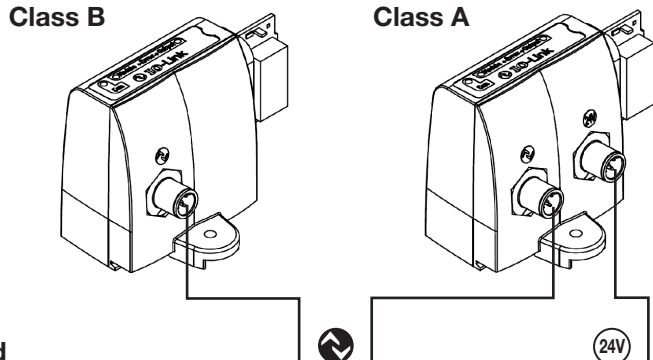

Legend

Symbol	Description
L+	IO-Link power supply "+"
L-	IO-Link power supply "-"
C/Q	IO-Link communication
Aux +	Auxiliary power supply 24 VDC
Aux -	Auxiliary power supply 0 VDC

M12 pin's	Class A		
	3 pin's	3 pin's	5 pin's
	P2M...A13	P2M...A43	P2M...A42
1	Aux +	Not used	Not used
2	-	-	Aux -
3	Aux -	Aux -	Not used
4	n.c.	Aux +	Aux +
5	-	-	Not used

Auxiliary Power Supply Compatibility

The P2M IO-Link Node can be powered from a 24VDC auxiliary source in PP or PM mode as grounds are isolated.

The P2M Safe Power Capable (-SPC) versions can be connected from a SAFE OSSD test pulsed power source.

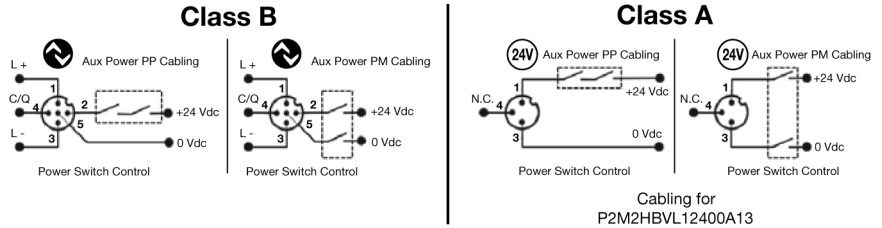

IO-Link Module Diagnostic Functions

The P2M IO-Link module offers additional useful module status information:

- Solenoid overload or short circuit
- Auxiliary voltage out of tolerance
- Cycle counter for each solenoid
- Module temperature

For more information on product technical information and module diagnostic functionalities, please refer to the user manual available from the product web page:

www.parker.com/pdn/P2M_IOL

COM Green LED			Module - Error Red LED			Error - Output Red LED			POWER Green LED		
LED Status	Description	Solving	LED Status	Description	Solving	LED Status	Description	Solving	LED Status	Description	Solving
OFF	IO-Link L+ / L- not powered	Check connection	OFF	Standard mode	NA	OFF	Standard mode	NA	OFF	AUX power failure	Check Auxiliary Power Supply
ON	IOL L+ / L- powered IO mode	Set IO-Link mode in IO-Link master	ON	24 VDC AUX power missing or any active malfunction	Check power supply or change module	ON	Any driver error (overload, over temperature, etc.)	Fix solenoid issue then acknowledge error	ON	Standard	NA
Blinking	IO-Link communication active	NA							Blinking	Aux Power is out of range, alarm level	Check Auxiliary Power Supply

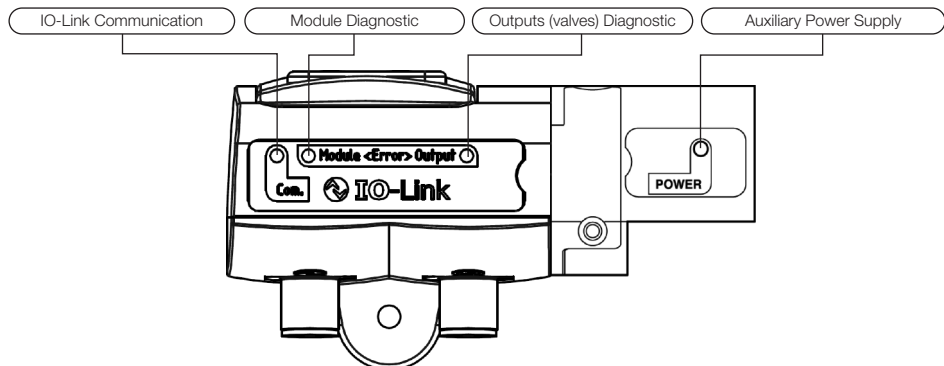

For inventory, lead times, and kit lookup, visit www.pdnplu.com

D
 Subbase & Manual
 Valves
 H Series
 Micro
 Modutefx
 Series
 H Series
 ISO
 Network
 Connectivity
 DX ISOMAX
 Series
 Valvair II
 Series

Input Data

One byte of diagnostic input data is transferred from P2M IO-Link to the IO-Link Master.

Process input data

7	6	5	4	3	2	1	0
Output driver SPI error	Output driver channel error	Polyfuse tripped	Temperature warning	SPI error	AUX voltage error	AUX voltage warning	Acknowledge Required

Output Data

Three bytes of process data are received by P2M IO-Link from the IO-Link Master for control of solenoids.

Process output data (Byte 0)

7	6	5	4	3	2	1	0
EV8	EV7	EV6	EV5	EV4	EV3	EV2	EV1

Process output data (Byte 1)

7	6	5	4	3	2	1	0
EV16	EV15	EV14	EV13	EV12	EV11	EV10	EV9

Process output data (Byte 2)

7	6	5	4	3	2	1	0
EV24	EV23	EV22	EV21	EV20	EV19	EV18	EV17

Solenoid Pilots Addressing and Process Mapping

P2M IO-Link node addressing used with Moduflex Valve System

The P2M IO-Link node, when used with Moduflex Valve System can handle up to 19 pilot solenoid valves. Addressing will be done as shown below.

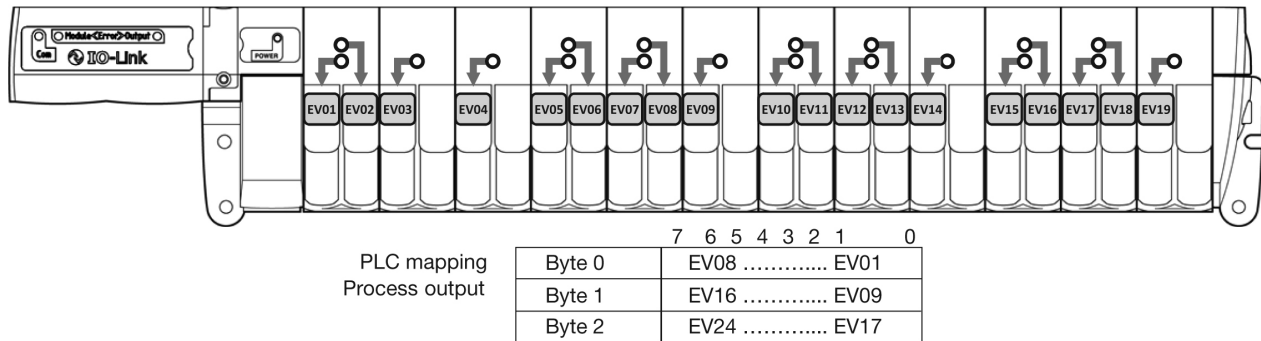

P2M IO-Link Module Electrical Specifications

IO-Link power supply	According to IO-Link standard V1.1.2
Speed communication	Com 2 – 38 kBd
Auxiliary power supply	20.4 VDC to 26.4 VDC
Current limit per channel	150 mA
Max current limit	4 A
Polarity inversion	YES
Short circuit protection	YES
Operating temperature	0°C to 55°C
Storage temperature	-25°C to 70°C
Shock according to IEC	60068-2-27:2008
Vibration according to IEC	60068-2-6:2007
EMC according to IEC	61000-4-2 up to -4-6

Network Diagnostic Through Process Mapping:

The P2M IO-Link module offers diagnostic data transmitted to the PLC through the master:

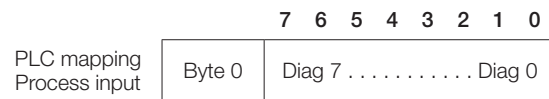

Diag bit	Error message	Detail
Diag 0.....	Fail-safe status	Acknowledgement required
Diag 1.....	Auxiliary voltage warning.....	Check auxiliary power
Diag 2.....	Auxiliary voltage failure.....	Check auxiliary power
Diag 3.....	Module failure	Module HS. must be replaced
Diag 4.....	Module over-temperature	
Diag 5.....	Module over-load	
Diag 6.....	Pilot solenoid(s) short circuit.....	Solenoid must be replaced
Diag 7.....	Outputs stage failure	







For further details, refer to the user manual: can be downloaded from www.parker.com/pdn/P2M_IOL



For inventory, lead times, and kit lookup, visit www.pdnplu.com

Accessories

Peripheral Modules

Accessories	Description	Option	Part Number		
			Size 1	Size 2	
	Pressure regulator without gauge	0 to 30 PSI	P2M1PXST	P2M2PXST	
		0 to 60 PSI	P2M1PXSL	P2M2PXSL	
		0 to 120 PSI	P2M1PXSN	P2M2PXSN	
	Pressure regulator with gauge	0 to 30 PSI	P2M1PXSR	P2M2PXSR	
		0 to 60 PSI	P2M1PXSM	P2M2PXSM	
		0 to 120 PSI	P2M1PXSG	P2M2PXSG	
	Gauge	0 to 30 PSI	P2M1K0GT	P2M1K0GT	
		0 to 60 PSI	P2M1K0GL	P2M1K0GL	
		0 to 120 PSI	P2M1K0GN	P2M1K0GN	
	Push to connect fitting	5/32" or 4mm OD tube	Elbow	CMD04-1	
			Straight	FMD04-1	
		1/4" OD tube	Elbow	CMD07-1B	CMD07-2B
			Straight	FMD07-1B	FMD07-2B
		3/8" OD tube	Elbow		CMD09-2B
			Straight		FMD09-2B
		1/2" OD tube	Straight		FMD13-2B
			6mm OD tube	Elbow	CMD06-1
		8mm OD tube	Straight	FMD06-1	FMD06-2
			Elbow		CMD08-2
		10mm OD tube	Straight		FMD08-2
			Elbow		CMD10-2
	Double male union	Straight		FMD10-2	
		Connecting peripheral modules	HMDXX1	HMDXX2	
	Muffler for vacuum exhaust port		MMDVA1	MMDVA2	
	Plug		PMDYY1	PMDYY2	

Note: 85 Durometer minimum for pneumatic connectors.

D

Subbase & Manual Valves

H Series Micro

Moduflex Series

H Series ISO

Network Connectivity

DX ISOMAX Series

Valvair II Series



For inventory, lead times, and kit lookup, visit www.pdnplu.com

Dual P.O. Check Valve

Combined with a double 3/2 NC + NC valve, this module will block both flows and stop cylinder movement as soon as the valve's outputs are both exhausted. Better than a 3-Position valve, it provides more precise positioning when fitted close to the cylinder. Standard with manual release buttons.

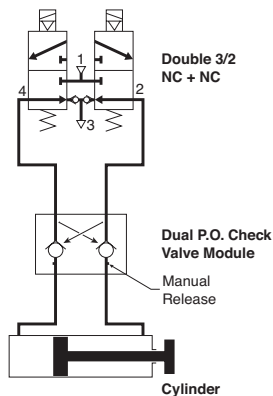

P2M1PXCA

Application

At the outputs of a double 3/2 NC + NC valve, the dual P.O. check valve module achieves efficient and stable cylinder positioning. As soon as both lines are exhausted by the main control valve, the two internally piloted check valves close tight. The cylinder is then stabilized.

The manual pressure releases may then eventually be used for an adequate machine positioning.

Dual P.O. Check Valve

	Part Number
Size 1	P2M1PXCA
Size 2	P2M2PXCA

Dual Flow Control

By controlling the exhaust flows of a double-acting cylinder, this module can adjust both speeds — extend and retract. It may be plugged into the valve module output ports or mounted close to the cylinder in its in-line version.

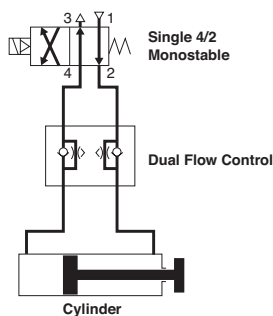

P2M1PXFA

Application

On a double-acting cylinder, extend and retract speeds are adjusted separately by control of air flow exhaust. The control becomes more precise when the flow adjustment is close to the cylinder. The examples show different solutions which are dependent upon the valve-to-cylinder distance and accessibility to the cylinder

Dual Flow Control Module

	Weight	Part Number
Size 1	1.06 oz	P2M1PXFA
Size 2	1.59 oz	P2M2PXFA



For inventory, lead times, and kit lookup, visit www.pdnplu.com

Accessories

“P” Series Peripheral Modules Model Number Index
(Complete with Pneumatic Connectors)

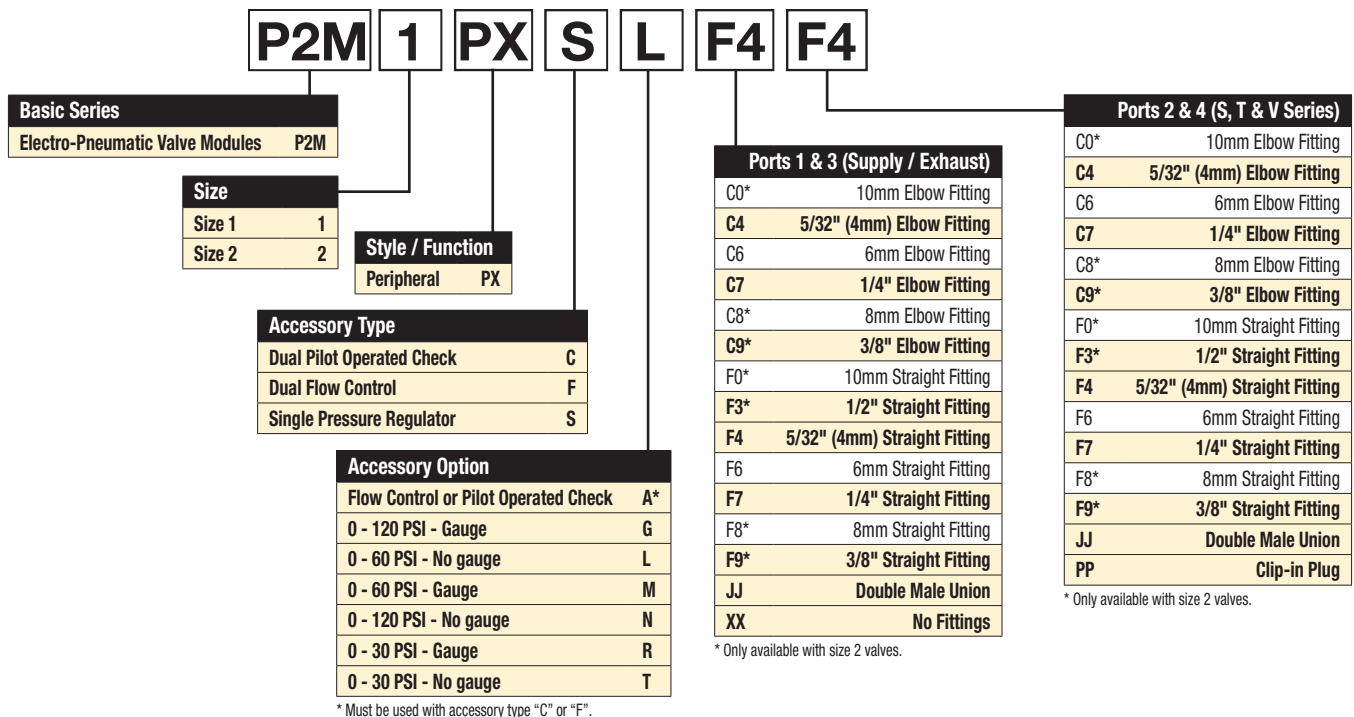

D
 Subbase & Manual Valves
 H Series Micro
 Moduflex Series
 H Series ISO
 Network Connectivity
 DX ISOMAX Series
 Valvair II Series

Regulator with Gauge



How to Order - Example: Size 1, Regulator with gauge, 1/4" OD straight fittings.

Line item	Quantity	Part Number	Description
Complete Peripheral Module			
1	1	P2M1PXSGF7F7	Size 1, Regulator with 0-160 PSI Gauge, 1/4" OD Straight Port Fittings in port 1, 2, 3, 4
Components			
1	1	P2M1PXSG	Size 1, Regulator with 0-160 PSI Gauge
2	4	FMD07-1B	Size 1-1/4" OD Tube Push-In Connector

Flow Control with Fittings



How to Order - Example: Size 1, Dual Flow Control, 1/4" OD straight fittings.

Line item	Quantity	Part Number	Description
Complete Peripheral Module			
1	1	P2M1PXFAF7F7	Size 1, Dual Flow Control, 1/4" OD Straight Port Fittings in Port 1, 2, 3, 4
Components			
1	1	P2M1PXFA	Size 1, Dual Flow Control
2	4	FMD07-1B	Size 1-1/4" OD Tube Push-In Connector



For inventory, lead times, and kit lookup, visit www.pdnplu.com

Vacuum Generator Applications

Depending on the application requirements, this vacuum generator may be controlled by single or by a dual 3/2 Moduflex valve. The Vacuum Generator has an integrated blow-off chamber that helps destroy the degree of vacuum. Blow-off can be increased with the addition of a control air input to the blow-off port on the vacuum module. A Ø6 mm port is available for an optional plug-in vacuum sensor for delivering a vacuum feedback signal.



Description	Weight	Size
Vacuum Generator	.88 oz	P2M1PXVA

Single 3/2 NC Air Control Valve

The 3/2 valve delivers the air supply to generate vacuum through the venturi. It also pressurizes the integrated blow-off chamber. When the 3/2 valve cuts-off the air supply, this chamber is automatically exhausted into the vacuum channel in order to speed-up the part release. In this type of application, it is preferred to have the vacuum generator mounted away from the control valve.

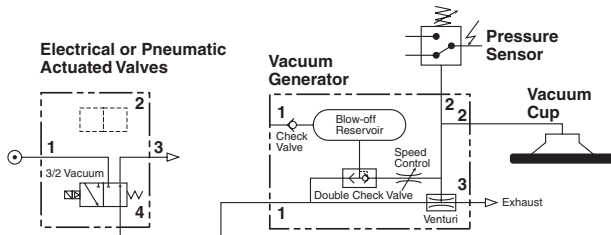

Dual 3/2 3/2 Valve Control

One 3/2 valve controls air supply for vacuum. The other 3/2 valve will generate an additional blow-off that may prove necessary to obtain quick part release from large vacuum pads. The effect of the blow-off can be controlled with an adjustable screw. In this type of circuit, the Vacuum Generator can be mounted directly to the valve by using Double Male Unions or as a stand alone item away from the control valve.

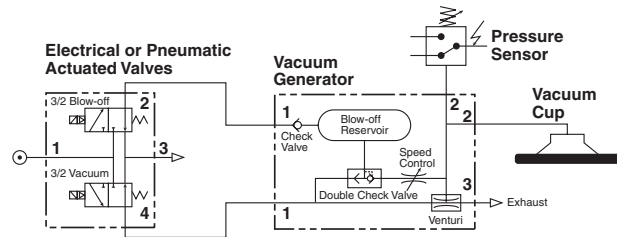

Vacuum Flow (SCFM)

Nozzle Diameter	inHg										
	0	3	6	9	12	15	18	21	24	27	30
P2M1PXVA	0.84	0.76	0.67	0.55	0.42	0.30	0.18	0.06	—	—	—

Evacuation Time

Series / Nozzle Diameter	Air Supply Pressure	Air Consumption	Evacuation Time in Sec / ft ³ * to Reach Different Vacuum Levels (inHg)								
	PSI	SCFM	3	6	9	12	15	18	21	24	27
P2M1PXVA	70	1.60	5.6	14.2	22.0	42.4	62.3	85.0	116	198	—

* 1 ft³ = 28.31 liters

Vacuum Generator Model Number Index

P2M1PXVA F7 A F7 C MA

Basic Configuration	#1 Pressure Port	#2 Sensor Port	#2 Vacuum Port	#3 Exhaust Port
Basic Unit: P2M1PXVA	5/32" (4mm) Elbow: C4 6mm Elbow: C6 1/4" Elbow: C7 Joint Fitting: JJ 5/32" (4mm) Straight: F4 6mm Straight: F6 1/4" Straight: F7 No Fittings: XX	A: 6mm Plug B: Plug K: 1/4" Straight L: 1/4" Elbow M: 6mm Elbow	C4: 5/32" (4mm) Elbow C6: 6mm Elbow C7: 1/4" Elbow F4: 5/32" (4mm) Straight F6: 6mm Straight F7: 1/4" Straight MA: Muffler	
Port #1 Configuration	Fitting in Pressure Port and Blow-Off Port: A Fitting in Pressure Port and Blow-Off Port Plugged*: B			

* Can not be directly mounting to valve.



For inventory, lead times, and kit lookup, visit www.pdnplu.com

Intermediate Supply Module Model Number Index

P2M2BX V 0 4 F9 MM

Intermediate Supply Module	
Basic Unit	P2M2BX

Valve Type	
Individually Wired	T
Collective Wiring	V

Wiring Style	
No Cable	0

Plate Configuration	
#1 & #3 Blocked	1
#1 Open & #3 Blocked	2
#1 Blocked & #3 Open	3
#1 & #3 Open	4

Inlet Port Type (#1 pressure)*	
C0	10mm Elbow Fitting
C2	12mm Elbow Fitting
C6	6mm Elbow Fitting
C7	1/4" Elbow Fitting
C8	8mm Elbow Fitting
C9	3/8" Elbow Fitting
F0	10mm Straight Fitting
F2	12mm Straight Fitting
F3	1/2" Straight Fitting
F6	6mm Straight Fitting
F7	1/4" Straight Fitting
F8	8mm Straight Fitting
F9	3/8" Straight Fitting
MM	Clip-in Muffler
PP	Clip-in Plug

Exhaust Port Type (#3 exhaust)*	
C0	10mm Elbow Fitting
C2	12mm Elbow Fitting
C6	6mm Elbow Fitting
C7	1/4" Elbow Fitting
C8	8mm Elbow Fitting
C9	3/8" Elbow Fitting
F0	10mm Straight Fitting
F2	12mm Straight Fitting
F3	1/2" Straight Fitting
F6	6mm Straight Fitting
F7	1/4" Straight Fitting
F8	8mm Straight Fitting
F9	3/8" Straight Fitting
MM	Clip-in Muffler
PP	Clip-in Plug

* Elbow fittings face up.

* Elbow fittings face up.

D
 Subbase & Manual Valves
 H Series Micro
 Moduflex Series
 H Series ISO
 Network Connectivity
 DX ISOMAX Series
 Valvair II Series

Plate Configuration



#1 & #3 Blocked

#1 Port connected to valves on the right only. Left is blocked.
 #3 Port connected to valves on the right only. Left is blocked.



#1 Open, #3 Blocked

#1 Port connected to valves on the right and the left.
 #3 Port connected to valves on the right only. Left is blocked.



#1 Blocked, #3 Open

#1 Port connected to valves on the right only. Left is blocked.
 #3 Port connected to valves on the right and the left.



#1 & #3 Open

#1 Port connected to valves on the right and the left.
 #3 Port connected to valves on the right and the left.



For inventory, lead times, and kit lookup, visit www.pdnplu.com

D60

Parker Hannifin Corporation
 Pneumatic Division
 Richland, Michigan
www.parker.com/pneumatics

Solenoid Pilot 24VDC

Description	Part Number
Solenoid pilot (without plug-in electrical connector)	P2D8V32C5
Air pilot with 5/32" (4mm) tube fitting	P2M2K0PA
Solenoid pilot (without clip connector)	P2D2W3226C5



P2D2W3226C5



P2D8V32C5



P2M2K0PA

Size 1 Valve
Without Solenoid Pilot
and Without Subbase
4-way / 2-position / Single Valve

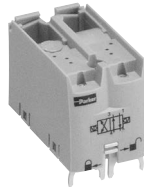

P2M1X4EE

Solenoid	Part Number
Single solenoid (Monostable)	P2M1X4ES
Double solenoid (Bistable)	P2M1X4EE

4-way / 2-position / Dual Valve

Solenoid	Part Number
Solenoid spring with exhaust check	P2M1XJEE

3-way / 2-position / Dual Valve

Solenoid	Part Number
Double solenoid NC + NC with exhaust check	P2M1XDDEE
Double solenoid NO + NO with exhaust check	P2M1XCDEE
Double solenoid NC + NO with exhaust check	P2M1XDEEE
Single solenoid NC with exhaust check	P2M1X3DES

Set of Maintenance Parts

Description	Part Number
Clips Set of 14 clips: 6 for size 1 valves, 2 for size 2 valves, 4 for dual 4/2 valves, 2 for end plate and intermediate modules	P2M2K0CA
Seals Set of 10 seals: 3 for manifold to manifold seals, 3 under solenoid pilot seals, 4 under valve seals (two size 1 seals, two size 2 seals)	P2M2K0JA
Forks Set of 10 isolation forks for solenoid pilot manual override	P2M2K0FA

Size 2 Valve
Without Solenoid Pilot
and Without Subbase
4-way / 2-position / Dual Valve

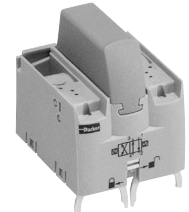

P2M2X4EE

Solenoid	Part Number
Single solenoid (Monostable)	P2M2X4ES
Double solenoid (Bistable)	P2M2X4EE

3-way / 2-position / Dual Valve

Solenoid	Part Number
Double solenoid NC + NC with exhaust check	P2M2XDDEE
Double solenoid NO + NO with exhaust check	P2M2XCDEE
Double solenoid NC + NO with exhaust check	P2M2XDEEE
Single solenoid NC with exhaust check	P2M2X3DES

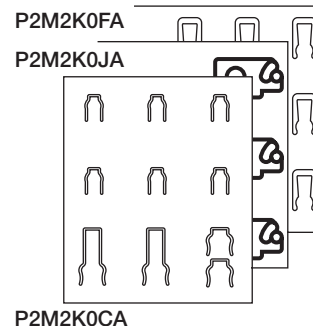

For inventory, lead times, and kit lookup, visit www.pdnplu.com

D61

Parker Hannifin Corporation
 Pneumatic Division
 Richland, Michigan
www.parker.com/pneumatics

D

Subbase & Manual Valves

H Series Micro

Moduflex Series

H Series ISO

Network Connectivity

DX ISOMAX Series

Valvair II Series

Ordering Information

Moduflex Add-A-Fold Assembly Model Number Index
(Complete with Pneumatic and Electrical Connectors)

How To Order Plug-in Add-A-Fold Assemblies

1. List Add-A-Fold Assembly call out. This automatically includes the end plate kit assembly.
2. List valves and manifolds. List left to right, LOOKING AT THE CYLINDER PORTS on the manifold.

P2MA V 0 1 C9 C9 ##

Moduflex Island Assembly	
Add-A-Fold	P2MA*

*Includes pneumatic H & T end plate kit.

Style	
Individually Wired	T
Collective Wiring	V*

* Includes 20-pin multi-connector or 25-pin, D-sub electrical head module.

Wiring / Bus Protocol	
No Cable (20-pin or multi-connector T series)	0 †
2 Meter Cable (20-pin)	2
5 Meter Cable (20-pin)	5
9 Meter Cable (20-pin)	9
Bus	B*
No Cable (25-pin, D-sub)	D
3 Meter Cable (25-pin, D-sub)	F

* Order bus module as a separate line item.
† Default to option "0" for T series.

Pilot Source	
Internal Supply / Internal Exhaust	1
Internal Supply / External Exhaust	2
External Supply / Internal Exhaust	3
External Supply / External Exhaust	4

Number of Stations ^f	
01 - 19*	V-Type
01 - 30	T-Type

* Max. number of addresses for V type is 19. Single solenoid valves equal one address. Double solenoid valves equal two addresses. Maximum address may depend upon choice of bus protocol.

† Intermediate modules are considered stations, but do not count against maximum number of addresses for manifold.

Exhaust Port Type (#3 Exhaust)*	
C0	10mm Elbow Fitting
C2	12mm Elbow Fitting
C6	6mm Elbow Fitting
C7	1/4" Elbow Fitting
C8	8mm Elbow Fitting
C9	3/8" Elbow Fitting
F0	10mm Straight Fitting
F2	12mm Straight Fitting
F3	1/2" Straight Fitting
F6	6mm Straight Fitting
F7	1/4" Straight Fitting
F8	8mm Straight Fitting
F9	3/8" Straight Fitting
MM	Clip-in Muffler
PP	Clip-in Plug

* Elbow fittings face up.

Inlet Port Type (#1 pressure)*	
C0	10mm Elbow Fitting
C2	12mm Elbow Fitting
C6	6mm Elbow Fitting
C7	1/4" Elbow Fitting
C8	8mm Elbow Fitting
C9	3/8" Elbow Fitting
F0	10mm Straight Fitting
F2	12mm Straight Fitting
F3	1/2" Straight Fitting
F6	6mm Straight Fitting
F7	1/4" Straight Fitting
F8	8mm Straight Fitting
F9	3/8" Straight Fitting
MM	Clip-in Muffler
PP	Clip-in Plug

* Elbow fittings face up.



"V" Series with 20-pin Connector



"V" Series with IO-Link

D
Subbase & Manual Valves
H Series Micro
Moduflex Series
H Series ISO
Network Connectivity
DX ISOMAX Series
Valvair-II Series



For inventory, lead times, and kit lookup, visit www.pdnplu.com

Ordering Information

How to Order -

Example: Application requires V Series valves with 20-Pin, D-Sub and 2 Meter cable. Manifold to include (1) Size 2, 4/2 Double Solenoid Valve - 3/8" OD fitting, (1) Size 1, 4/2 Single Solenoid Valve - 1/4" OD Elbow Fitting, Intermediate Module - 3/8" OD Fitting with Exhaust Muffler, Port 1 and 3 Blocked, (1) Size 1, Dual 3/2 NC Valve and (1) Size 1, 4-Way Double Solenoid Valve both with 1/4" OD Straight Fittings. Includes 3/8 OD Inlet Fitting and Exhaust Muffler.

Line Item	Quantity	Part Number	Description
Complete Manifold Assembly			
1	1	P2MAV21F9MM05	Moduflex Island Assembly, Pneumatic Head and Tail Module Set, Internal Pilot Supply, Internal Pilot Exhaust, 3/8" Straight Fitting Port 1, Port 3 Muffler.
2	1	P2M2V4EE2CV00F9	Size 2, Double Solenoid, 4/2, 3/8" Straight Pneumatic Connectors.
3	1	P2M1V4ES2CV00C7	Size 1, Single Solenoid, 1/4" Elbow Pneumatic Connectors.
4	1	P2M2BXV0A1F9MM	Intermediate Module 3/8" Straight Fitting with Exhaust Muffler
5	1	P2M1VDEE2CV00C7	Size 1, Dual 3/2 NC + NC, 1/4" Elbow Pneumatic Connectors.
6	2	P2M1VJEE2CV00F7	Size 1, Dual 4/2, 1/4" Straight Pneumatic Connectors.

Components

1	1	P2M2HXT01	Pneumatic Head and Tail Module Set
2	1	P2M2HEV0A	20-Pin, Multi-Connector Electrical Head Module
3	1	P8LMH20M2A	2 Meter, 20-Pin Cable
4	1	P2M2V4EE2CV	Size 2, V Series Island Valve Module, Double Solenoid, 4-Way
5	1	P2M1V4ES2CV	Size 1, V Series Island Valve Module, Single Solenoid, 4-Way
6	1	P2M2BXV0A	Intermediate Module
7	1	P2M1VGEE2CV	Size 1, V Series Island Valve Module, Dual 3/2 NC + NC
8	2	P2M1VJEE2CV	Size 1, V Series Island Valve Module, Dual 4/2
9	2	CMD07-1B	Size 1, 1/4" OD Tube Elbow Push-in Connector
10	6	FMD07-1B	Size 1, 1/4" OD Tube Straight Push-in Connector
11	4	FMD09-2B	Size 2, 3/8" OD Tube Straight Push-in Connector
12	2	MMDVA2	Clip-on Muffler

How to Order -

Example: Application requires V Series valves with IO-Link Class A Module. Manifold to include (1) Size 2, 4/2 Double Solenoid Valve - 3/8" OD fitting, (1) Size 1, 4/2 Single Solenoid Valve - 1/4" OD Elbow Fitting, Intermediate Module - 3/8" OD fitting with Exhaust Muffler, Port 1 and 3 Blocked, (1) Size 1, Dual 3/2 NC Valve and (1) Size 1, 4-Way Double Solenoid Valve both with 1/4" OD Straight Fittings. Include 3/8 OD Inlet Fitting and Exhaust Muffler.

Line Item	Quantity	Part Number	Description
Complete Manifold Assembly			
1	1	P2MAVB1F9MM05	Moduflex Island Assembly, Pneumatic Head and Tail Module Set, Internal Pilot Supply, Internal Pilot Exhaust, 3/8" Straight Fitting Port 1, Port 3 Muffler.
2	1	P2M2HBVL12400AB	IO-Link Class A Module
3	1	P2M2V4EE2CV00F9	Size 2, Double Solenoid, 4/2, 3/8" Straight Pneumatic Connectors.
4	1	P2M1V4ES2CV00C7	Size 1, Single Solenoid, 1/4" Elbow Pneumatic Connectors.
5	1	P2M2BXV0A1F9MM	Intermediate Module 3/8" Straight Fitting with Exhaust Muffler
6	2	P2M1VDEE2CV00C7	Size 1, Dual 3/2 NC + NC, 1/4" Elbow Pneumatic Connectors.
7	1	P2M1VJEE2CV00F7	Size 1, Dual 4/2, 1/4" Straight Pneumatic Connectors.

Components

1	1	P2M2HXT01	Pneumatic Head and Tail Module Set
2	1	P2M2HBVL12400AB	IO-Link Class A Module
3	1	P2M2V4EE2CV	Size 2, V Series Island Valve Module, Double Solenoid, 4-Way
4	1	P2M1V4ES2CV	Size 1, V Series Island Valve Module, Single Solenoid, 4-Way
5	1	P2M2BXV0A	Intermediate Module
6	1	P2M1VGEE2CV	Size 1, V Series Island Valve Module, Dual 3/2 NC + NC
7	2	P2M1VJEE2CV	Size 1, V Series Island Valve Module, Dual 4/2
8	2	CMD07-1B	Size 1, 1/4" OD Tube Elbow Push-in Connector
9	6	FMD07-1B	Size 1, 1/4" OD Tube Straight Push-in Connector
10	4	FMD09-2B	Size 2, 3/8" OD Tube Straight Push-in Connector
11	2	MMDVA2	Clip-on Muffler



For inventory, lead times, and kit lookup, visit www.pdnplu.com

D63

Parker Hannifin Corporation
 Pneumatic Division
 Richland, Michigan
www.parker.com/pneumatics

D

Subbase & Manual Valves

H Series Micro

Moduflex Series

H Series ISO

Network Connectivity

DX ISOMAX Series

Valvair II Series

Internal and external pilot supply options

All T and V Series Valve bases incorporate an auxiliary channel "X" to supply pressure to the solenoid pilots. The "X" galley is pressurized from the left hand end plate. Depending on the configuration of the left hand end plate, this pressure is either supplied from the #1 port in the left hand end plate or supplied externally through a 4mm OD tube fitting in the left hand end plate. This fitting is supplied in all left hand end plates and can be converted in the field.

Internal and external solenoid pilot exhaust options

All T and V Series Valve bases incorporate an auxiliary channel "E" which is used to exhaust the solenoid pilot pressure from each solenoid valve. The "E" galley is connected to the left hand end plate. Depending on the configuration of the left hand end plate, this exhaust is either connected to the #3 exhaust port or is connected to a 4mm OD Tube fitting in the left hand end plate. This fitting is supplied in all left hand end plates and can be converted in the field.

To configure the left hand end plate, with pressure off, remove head cover to expose the selector section. Loosen selector section and rotate "X" or "E" channel selector to desired position. Tighten selector section and assemble cover.

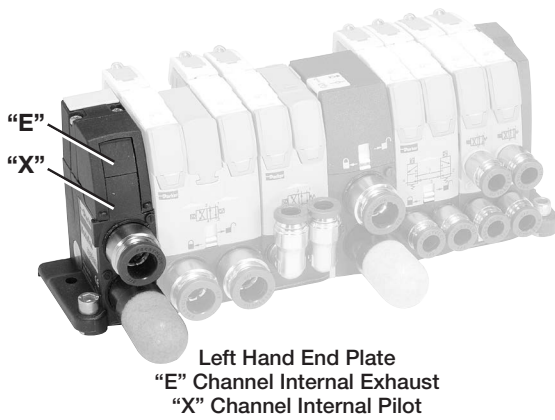
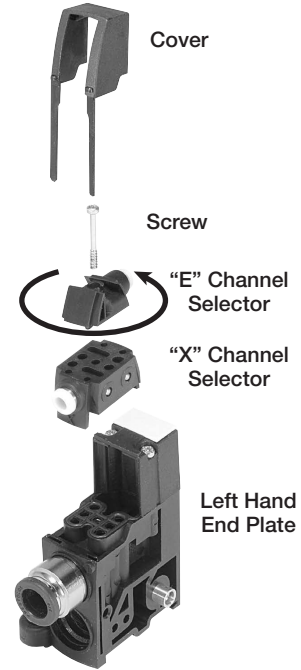

D	Subbase & Manual Valves
	H Series Micro
Moduflex Series	
H Series ISO	
Network Connectivity	
DX ISOMAX Series	
Valvair II Series	



For inventory, lead times, and kit lookup, visit www.pdnplu.com

“V”, “T” and “S” Series Maintenance

The latest generations of compact pneumatic valves have a life expectancy which generally exceeds the equipment they control. Therefore, maintenance is seldom required. When it

is necessary to change the solenoid pilot, valve or connector, they can be easily replaced without removing the island base, as shown below.

“S” Series

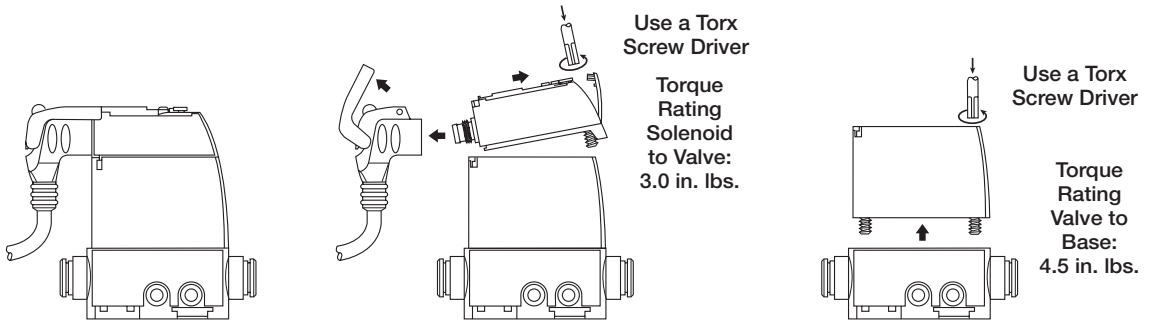

“T” Series

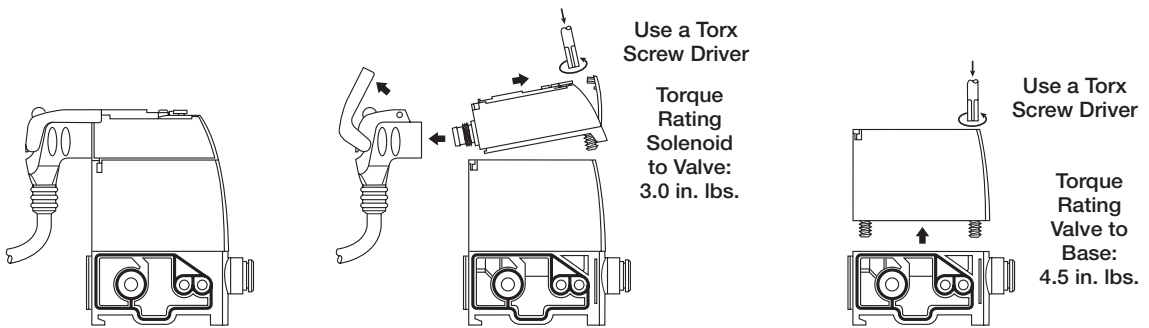

“V” Series

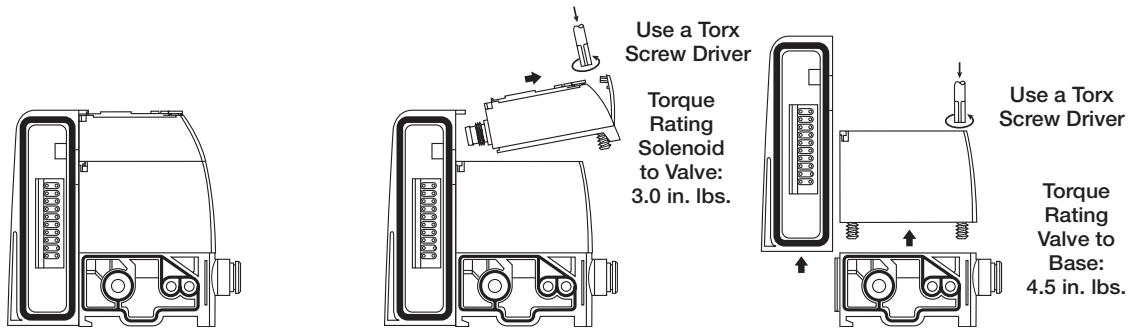

Fitting and Tubing Installation

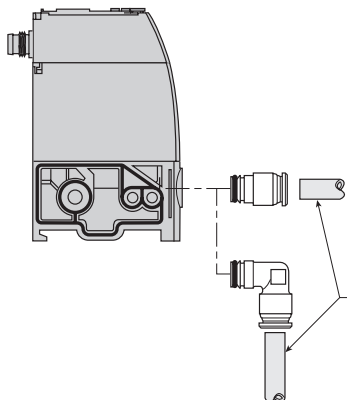

Fitting Assembly: Pneumatic Connectors are retained by a clip in each module. Assembly is achieved by pushing the fitting into the module and sliding the clip down over the groove in the fitting. Pull fitting to check that it is secure.

Tubing Assembly: Cut tubing squarely & cleanly. Inspect the tubing to insure there are no sharp edges that may nick or cut the o-ring seal. Insert tubing into fitting until it bottoms out. A slight pull on the tube afterwards can help verify it is properly retained / inserted.

Tubing Disassembly: When it is required to remove the tubing from the fitting push the release button in towards the fitting & remove the tubing.

Tubing Reassembly: Inspect the tubing before re-inserting it for any scoring or other damage that would affect the o-ring sealing. It is recommended that for every insertion, the tubing end be trimmed, especially if it has any scoring or damage.

Pneumatic Valve Specifications

Fluid	Air, inert gas, filtered 40µ ¹ , dry ² or lubricated ³		
Operating Pressures	Vacuum to 120 PSI		
Piloting Pressure	43 to 120 PSI for operating pressures below, use external pilot supply available on all head modules ⁵		
Pilot Supply	Internal with "S" Series, mixed internal / external with "T" and "V" Series		
Exhaust Collection	All exhausts are collectable, including solenoid pilot exhaust		
Life Cycle	100 million operations ⁴ (with dry air, 3 Hz, 20°C, 6 bar)		
Operating Temperatures	5°F to 140°F (32°F to 130°F for field bus systems)		
Stocking Temperatures	-40°F to 155°F		
Vibration Resistance	According to IEC 68 - 2 - 6	2G	2 to 150 Hz
Impact Resistance	According to IEC 68 - 2 - 27	15G	11 ms

1. Class 5 according to ISO 8573-1
2. Class 4 according to ISO 8573-1
3. 3. With main air supply lubricated, monitor lubrication rate so that valve bank is not flooded with lubricant.
4. 4/2 valve
5. Double 3/2 minimum 50 PSI

Electrical Specifications

Rated Coil Voltage	24VDC		
Allowable Voltage Fluctuation	-15% to +10 % of nominal voltage		
Electrical Connection	Polarity insensitive: PNP and NPN compatible		
Coil insulation Type	Class B		
Power Consumption	1W (42 mA)		
Manual Override	Locking or non-locking, isolated if required		
Response Time of the Complete Valve	9.6 ms ± 1.2 on 4/2 Double Solenoid Valve Size 1 12.0 ms ± 1.2 on 4/2 Single Solenoid Valve Size 1 14.8 ms ± 2 on 4/2 Double Solenoid Valve Size 2 17.0 ms ± 2 on 4/2 Single Solenoid Valve Size 2		According to ISO 12238
Type of Use	Continuous-duty Solenoid		
Dust and Water Protection	According to EN 60 529	"S" and "T" Series:	M8 IP67
			Clip IP40
		"V" Series:	IP65

Specifications

1/4", 3/8" and 1/2" Fittings

Construction

Nickel Plated Brass Body; O-ring: Nitrile (Buna N) lubricated with Silicone lubricant; Grab Ring: 301 Stainless Steel; One Piece Button Collet: PVDF – black

Recommended Parker Tubing Series:

E (Linear Low Density Polyethylene), PP (Polypropylene), N (Plasticized Polyamide, Nylon), NR (Unplasticized Polyamide, Rigid Nylon), U (Polyurethane 90 Durometer Shore A), HU (Polyurethane 95 Durometer Shore A)

Other materials: Polyurethane 85 Durometer Shore A – Applications and service conditions vary and therefore the use of a tube support may be required for any 85A PU tubing. The following commercially available O.D. – I.D. 85A tubing sizes require the use of a tube support regardless of application. (5/32" – 3/32", 3/16" – 1/8", 1/4" - .170", 1/4" – 3/16", 5/16" – 1/4", 3/8" – 5/16", 1/2" – 3/8")

Prestolok fittings should not be used for live swivel applications. Vacuum applications dependent upon temperature and type of tubing used.

6mm, 8mm, 10mm, 12mm Fittings

Construction

Polyamid HR Body (Right Angle), Nickel Plate Brass Body (Straight); O-ring: Nitrile (Buna N) lubricated with Silicone lubricant; Sleeve: Polyamide HR Body; Grab Ring: 301 Stainless Steel; One Piece Button Collet: Polyacetal - black

Recommended Parker Tubing Series for 6mm, 8mm, 10mm, 12mm Fittings:

E (Linear Low Density Polyethylene), N (Plasticized Polyamide, Nylon), U (Polyurethane 90 Durometer Shore A), HU (Polyurethane 95 Durometer Shore A)

Prestolok fittings should not be used for live swivel applications. Vacuum applications dependent upon temperature and type of tubing used.

D
 Subbase & Manual Valves
 H Series Micro
 Moduflex Series
 H Series ISO
 Network Connectivity
 DX ISOMAX Series
 Valvair II Series



For inventory, lead times, and kit lookup, visit www.pdnplu.com

D66

Parker Hannifin Corporation
 Pneumatic Division
 Richland, Michigan
www.parker.com/pneumatics

"S" Series Individual Subbase Valve Dimensions and Mounting

Subbase Valve Size 1



Subbase Valve Size 2



Surface Mounting with Screws 4 mm Dia. into Retractable Brackets 3mm Thick

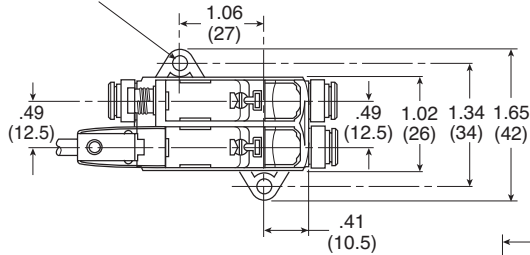

Surface Mounting with Screws 4 mm Dia. into Retractable Brackets 3mm Thick

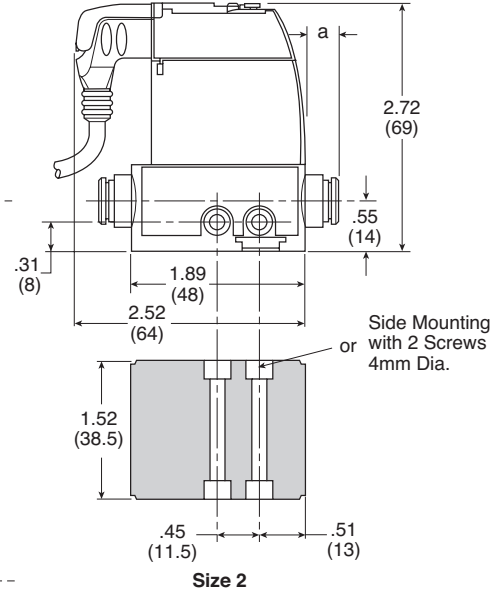
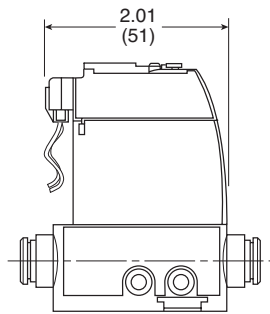
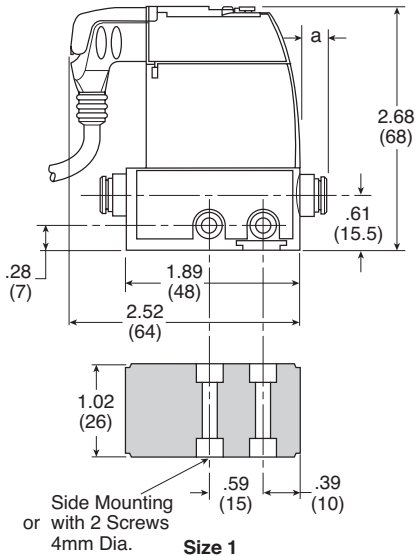
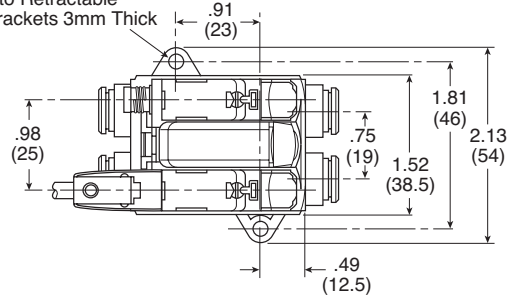

Side Mounting with 2 Screws 4mm Dia.

Air Pilot

OD Tube Ext.	a	b	c
5/32" (4 mm)	8	10	12
Size 1 Valves			
6 mm	8	13	16
1/4"	15	18	22
Muffler		31	
1/4"	12	18	22
Size 2 Valves			
8 mm	9	16	19
3/8"	16	23	26
10 mm	13	18	22
Muffler		40	

Special Case: 4/3 all ports blocked. Add the dual P.O. check valve that has been plugged in the basic valve.

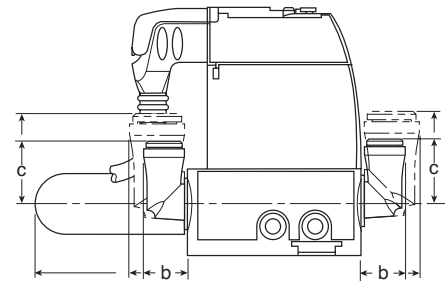

For inventory, lead times, and kit lookup, visit www.pdnplu.com

D67

Parker Hannifin Corporation
 Pneumatic Division
 Richland, Michigan
www.parker.com/pneumatics

D

Subbase & Manual Valves

H Series Micro

Moduflex Series

H Series ISO

Network Connectivity

DX ISOMAX Series

Valvair II Series

"T" Series Manifold Dimensions and Mounting



Total Width Depends on Valve Composition

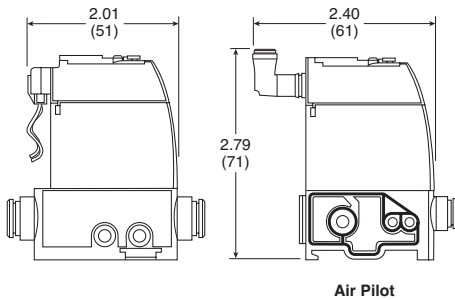
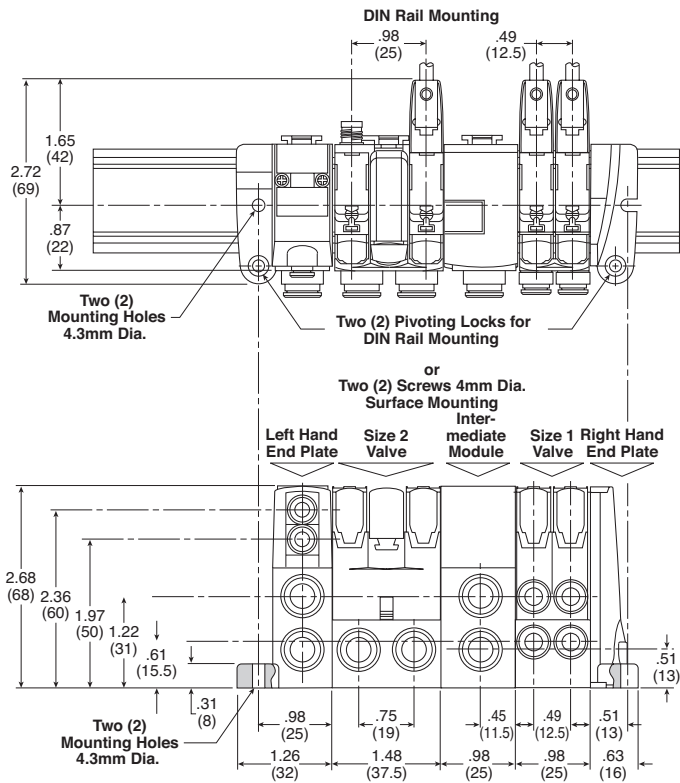
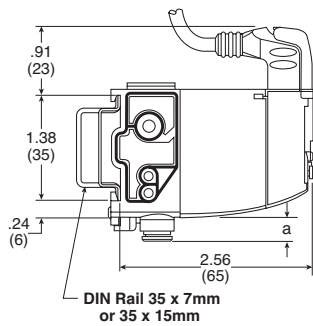

Special Case: 4/3 all ports blocked function within island version, add the dimensions of the dual P.O. check valve plugged into the island.

End Plate and Intermediate Modules

	a	b	c
6 mm Tube OD	8	13	16
1/4" Tube OD	12	18	22
8 mm Tube OD	9	16	19
3/8" Tube OD	16	23	26
10 mm Tube OD	13	18	25
12 mm Tube OD	13	19	25
1/2" Tube OD	13		
Muffler	40		

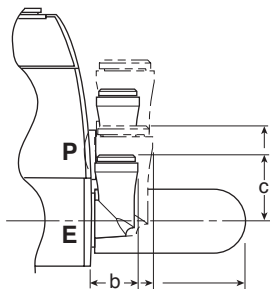

OD Tube	Ext.	a	b	c
Size 1 Valves	5/32" (4 mm)	8	10	12
	6 mm	8	13	16
Size 2 Valves	1/4"	15	18	22
	1/4"	12	18	22
	8 mm	9	16	19
	3/8"	16	23	26
	10 mm	13	18	22

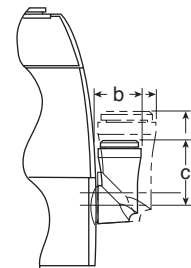

D
 Subbase & Manual Valves
 H Series Micro
 Moduflex Series
 H Series ISO
 Network Connectivity
 DX ISOMAX Series
 Valvair II Series



For inventory, lead times, and kit lookup, visit www.pdnplu.com

"V" Series Manifold Dimensions and Mounting
 20-pin, Multi-Connector Valve Manifold



Total Width Depends
 on Valve Composition

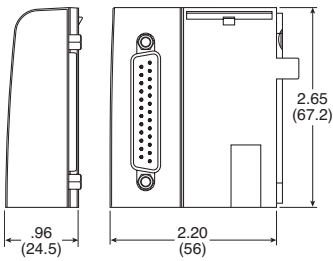
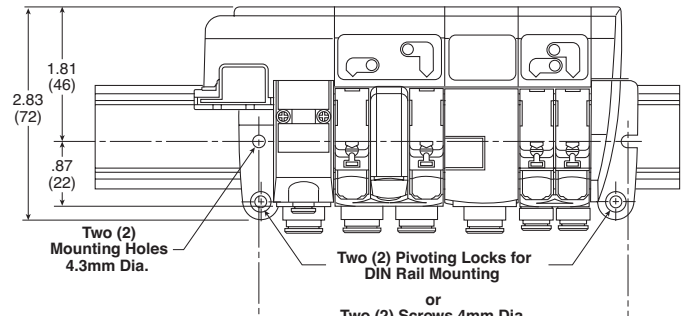
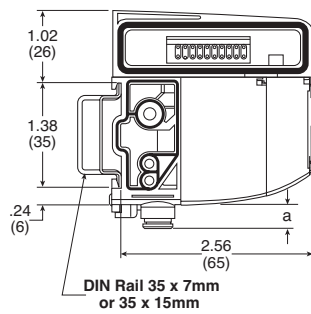

25-pin,
 D-Sub

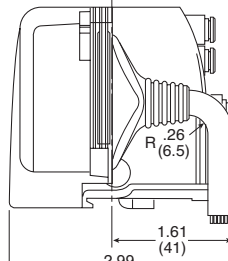

20-pin,
 Multi-Connector

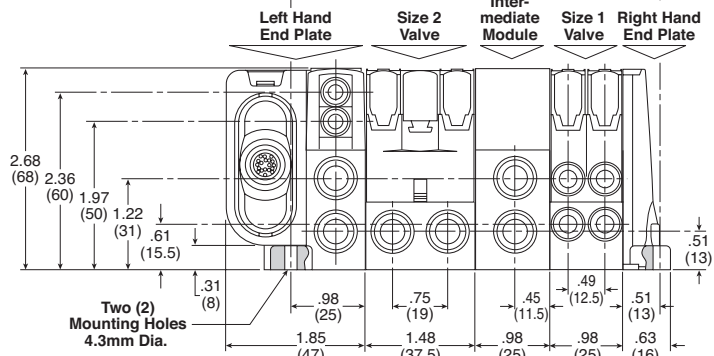

End Plate and Intermediate Modules

	a	b	c
6 mm Tube OD	8	13	16
1/4" Tube OD	12	18	22
8 mm Tube OD	9	16	19
3/8" Tube OD	16	23	26
10 mm Tube OD	13	18	25
12 mm Tube OD	13	19	25
1/2" Tube OD	13		
Muffler	40		

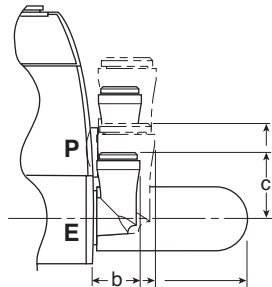

OD Tube	Ext.	a	b	c
	5/32" (4 mm)	8	10	12
Size 1 Modules	6 mm	8	13	16
	1/4"	15	18	22
Size 2 Modules	1/4"	12	18	22
	8 mm	9	16	19
	3/8"	16	23	26
	10 mm	13	18	22

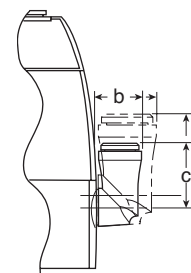

For inventory, lead times, and kit lookup, visit www.pdnplu.com

D69

Parker Hannifin Corporation
 Pneumatic Division
 Richland, Michigan
www.parker.com/pneumatics

D

Subbase & Manual Valves

H Series Micro

Moduflex Series

H Series ISO

Network Connectivity

DX ISOMAX Series

Valvair II Series

“V” Series Manifold Dimensions and Mounting
P2M Connected Valve Manifolds

Total Width Depends
 on Valve Composition



Industrial Ethernet and IO-Link P2M Network Nodes with Valve Manifold

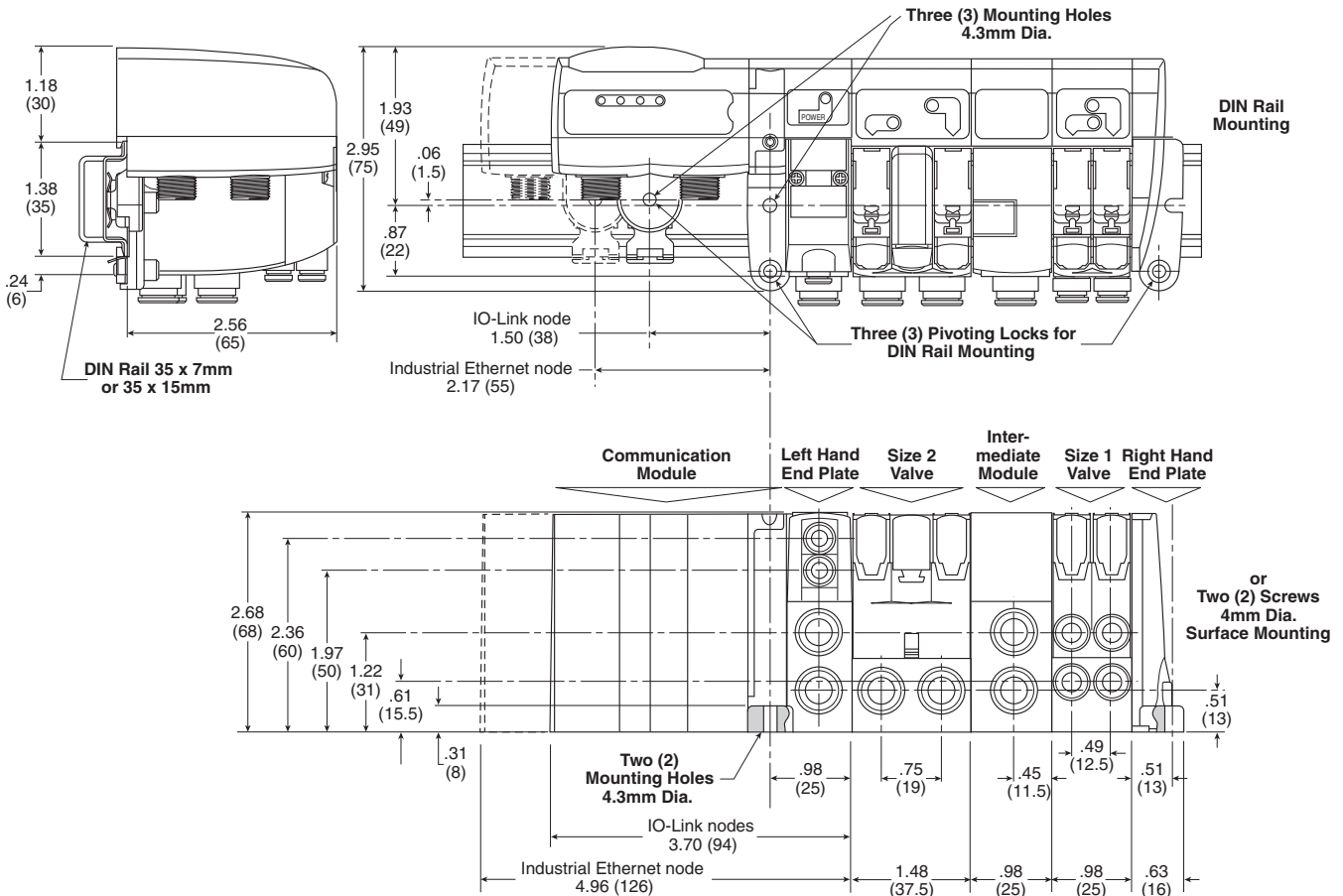

D	Subbase & Manual Valves
H Series Micro	
Modulflex Series	
H Series ISO	
Network Connectivity	
DX ISOMAX Series	
Valvair II Series	



For inventory, lead times, and kit lookup, visit www.pdnplu.com

D70

Parker Hannifin Corporation
 Pneumatic Division
 Richland, Michigan
www.parker.com/pneumatics

"P" Series Peripheral Modules Dimensions and Mounting

Reminder: Peripheral modules may either be plugged in the valve output ports or mounted in-line separate from the valve.

Peripheral Module Plugged in a Valve

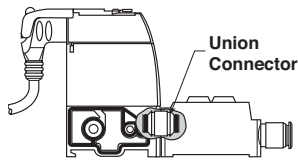

In-Line Peripheral Modules: Mounting is Required

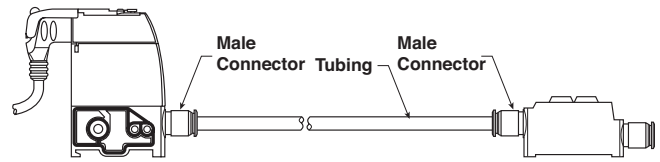

Dual Flow Control Size 1

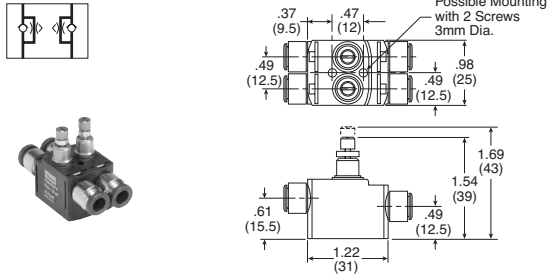

Dual Flow Control Size 2

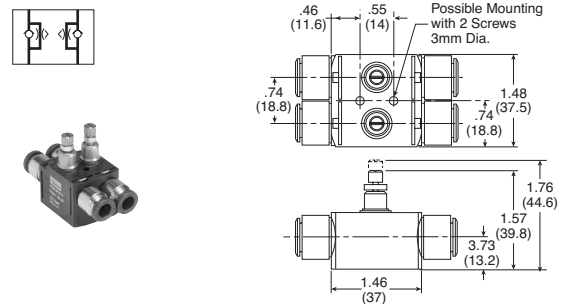

Pressure Regulator Size 1

With Gauge

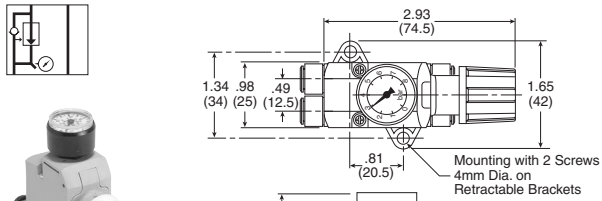

Pressure Regulator Size 2

With Gauge

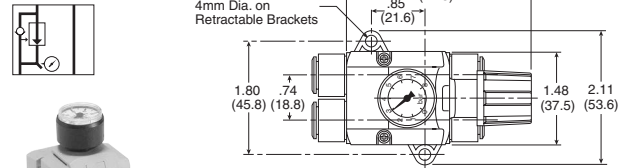

Without Gauge

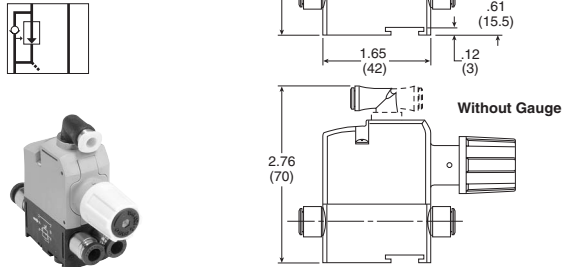

Without Gauge

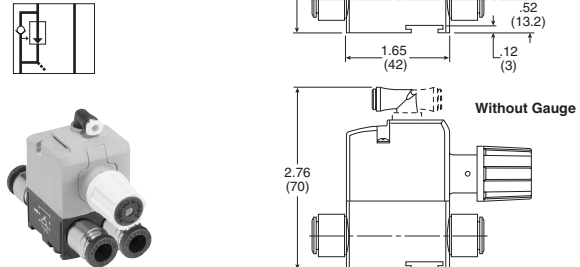

Dual P.O. Check Valve Size 1

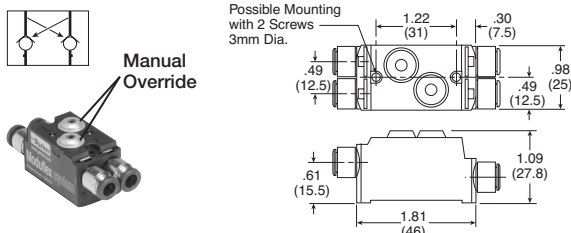

Dual P.O. Check Valve Size 2

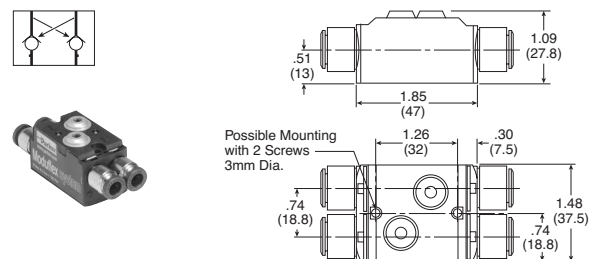

For inventory, lead times, and kit lookup, visit www.pdnplu.com

D

Subbase & Manual
Valves

H Series
Micro

Modulflex
Series

H Series
ISO

Network
Connectivity

DXISOMAX
Series

Valvair II
Series



For inventory, lead times, and kit lookup, visit www.pdnplu.com

D72

Parker Hannifin Corporation
Pneumatic Division
Richland, Michigan
www.parker.com/pneumatics

Features

H Series ISO

The H Series ISO valve conforms to international standards 15407 and 5599, providing maximum flexibility for end users. As Parker's premier manifold mount product offering, H Series ISO offers machine builders a complete offering with a wide variety of accessories and options in a valve family with flow ranges from 0.55 Cv up to 6.0 Cv. HB/HA/H1/H2/H3 can be mounted on the same manifold. Individual wiring is available with DIN or central connectors, and collective solutions offer installation time savings with either multi-pin connectors or network solutions.

Ports, Flow

- H Universal Manifold
 - HB: 1/8 inch, 0.55 Cv
 - HA: 1/4 inch, 1.1 Cv
 - H1: 3/8 inch, 1.5 Cv
 - H2: 1/2 inch, 3.0 Cv
- H Classic Manifold (not compatible with H Universal without H3 Transition Kit)
 - H3: 3/4 inch, 6.0 Cv
- NPT and BSPP "G" standard

Solenoids

- HB & HA: 24 VDC, 1.0 Watt, and 120 VAC, 1.0 VA
- H1, H2, & H3: 24 VDC, 3.2 Watt, 120 VAC, 4.5 VA, 24 VDC, 1.3 Watt

Certification / approval

- IP65 rated
- cCSAus approved voltages:
 - 15407-2 & 5599-2 24VDC manifolds only
 - 15407-2 & 5599-2 single subbase, all voltages
 - 15407-1 & 5599-1 manifold and single subbase, all voltages
- BSPP manifold and subbase ports meet ISO 1179 specifications

Operating Pressure

Maximum: 145 PSIG (1000 kPa)

Minimum: see below chart

Operator / Function	Internal Pilot	PSIG (Min. kPa) HB	PSIG (Min. kPa) HA	PSIG (Min. kPa) H1	PSIG (Min. kPa) H2	PSIG (Min. kPa) H3
1	Single solenoid - 2-position	30	25	25	25	35
2	Double solenoid- 2-position	(207)	(173)	(173)	(173)	(241)
3	Single remote pilot - 2-position**	Vacuum	Vacuum	Vacuum	Vacuum	Vacuum
4	Double remote pilot - 2-position**	Vacuum	Vacuum	Vacuum	Vacuum	Vacuum
5, 6, 7	Double solenoid - 3-position APB, CE, PC	35 (241)	35 (241)	35 (241)	50 (345)	50 (345)
8, 9, 0	Double remote pilot - 3-position** APB, CE, PC	Vacuum	Vacuum	Vacuum	Vacuum	Vacuum
E	Single solenoid pilot - 2-position					
	Air return / spring assist	30 (207)	30 (207)	35 (241)	45 (310)	45 (310)
F	Single remote pilot - 2-position**					
	Air return / spring assist					
N, P, Q	Double solenoid - dual 3/2	30 (207)	N/A	N/A	N/A	N/A
	External pilot*	*	*	*	*	*
All	H Series	Vacuum	Vacuum	Vacuum	Vacuum	Vacuum

* External Pilot Pressure / Remote Pilot Supply - Must meet or exceed minimum pilot pressure for internal pilot option. Not available on Operator / Function N, P, or Q.

** Must be equal to or greater than operating pressure.

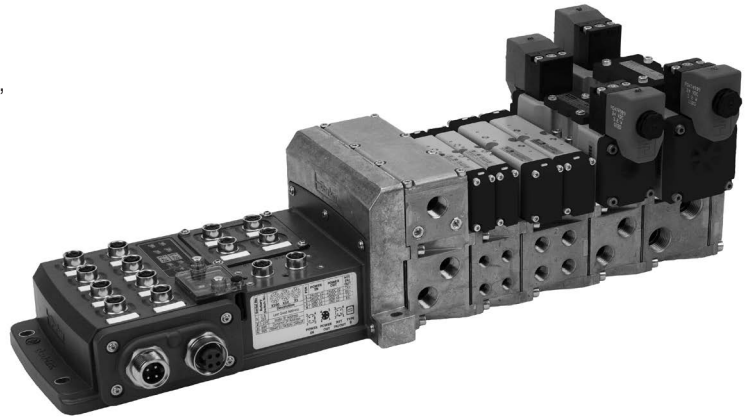

Operating information

Operating pressure:	Vacuum to 145 PSIG (Vacuum to 10 bar)
Pilot pressure:	See chart
Temperature range:	5°F to 120°F (-15°C to 49°C)

Material specifications

Body	Aluminum
End caps	PBT
End plates	Aluminum
Fasteners	Zinc plated steel
Manifolds	Aluminum
Seals	Nitrile
Spool	Aluminum





For inventory, lead times, and kit lookup, visit www.pdnplu.com

Features

H Series ISO

Right Sizing

-  ISO 15407-1 (Non Plug-in)
ISO 15407-2 (Plug-in)
-  ISO 5599-1 (Non Plug-in)
ISO 5599-2 (Plug-in)

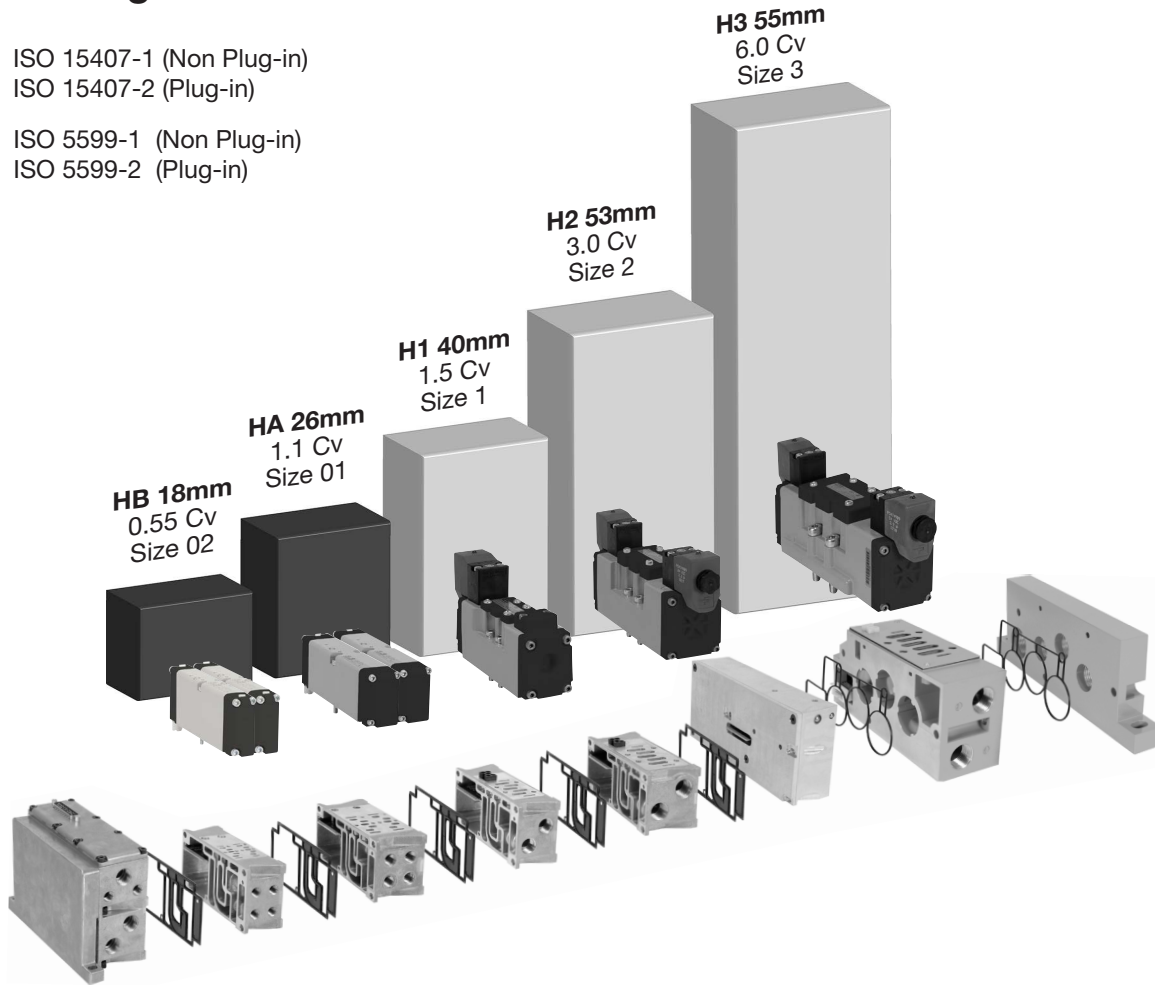

D
Subbase & Manual Valves

Cylinder Bore Size - inches (mm)

Cylinder Speed - in/s (mm/s)	Cylinder Bore Size - inches (mm)							
	1-1/4" (32 mm)	1-1/2" (40 mm)	2.00" (50 mm)	2-1/2" (63 mm)	3-1/4" (80 mm)	4.00" (100 mm)	5.00" (125 mm)	6.00" (150 mm)
1.96 (50)	0.03	0.04	0.06	0.10	0.17	0.26	0.41	0.59
3.93 (100)	0.05	0.08	0.13	0.21	0.35	0.53	0.82	1.19
5.90 (150)	0.08	0.12	0.20	0.31	0.52	0.79	1.24	1.78
7.87 (200)	0.10	0.16	0.26	0.41	0.69	1.05	1.64	2.37
9.84 (250)	0.13	0.20	0.33	0.52	0.87	1.32	2.06	2.97
11.81 (300)	0.16	0.25	0.40	0.62	1.05	1.58	2.47	3.56
13.77 (350)	0.18	0.29	0.46	0.72	1.22	1.85	2.88	4.15
15.74 (400)	0.21	0.33	0.53	0.82	1.39	2.11	3.30	4.75
17.71 (450)	0.24	0.37	0.59	0.93	1.57	2.37	3.71	5.34
19.68 (500)	0.26	0.41	0.66	1.03	1.74	2.64	4.12	5.94
	HB		HA		H1	H2	H3	



D74



For inventory, lead times, and kit lookup, visit www.pdnplu.com

Parker Hannifin Corporation
Pneumatic Division
Richland, Michigan
www.parker.com/pneumatics

Connectivity

EtherNet/IP DeviceNet

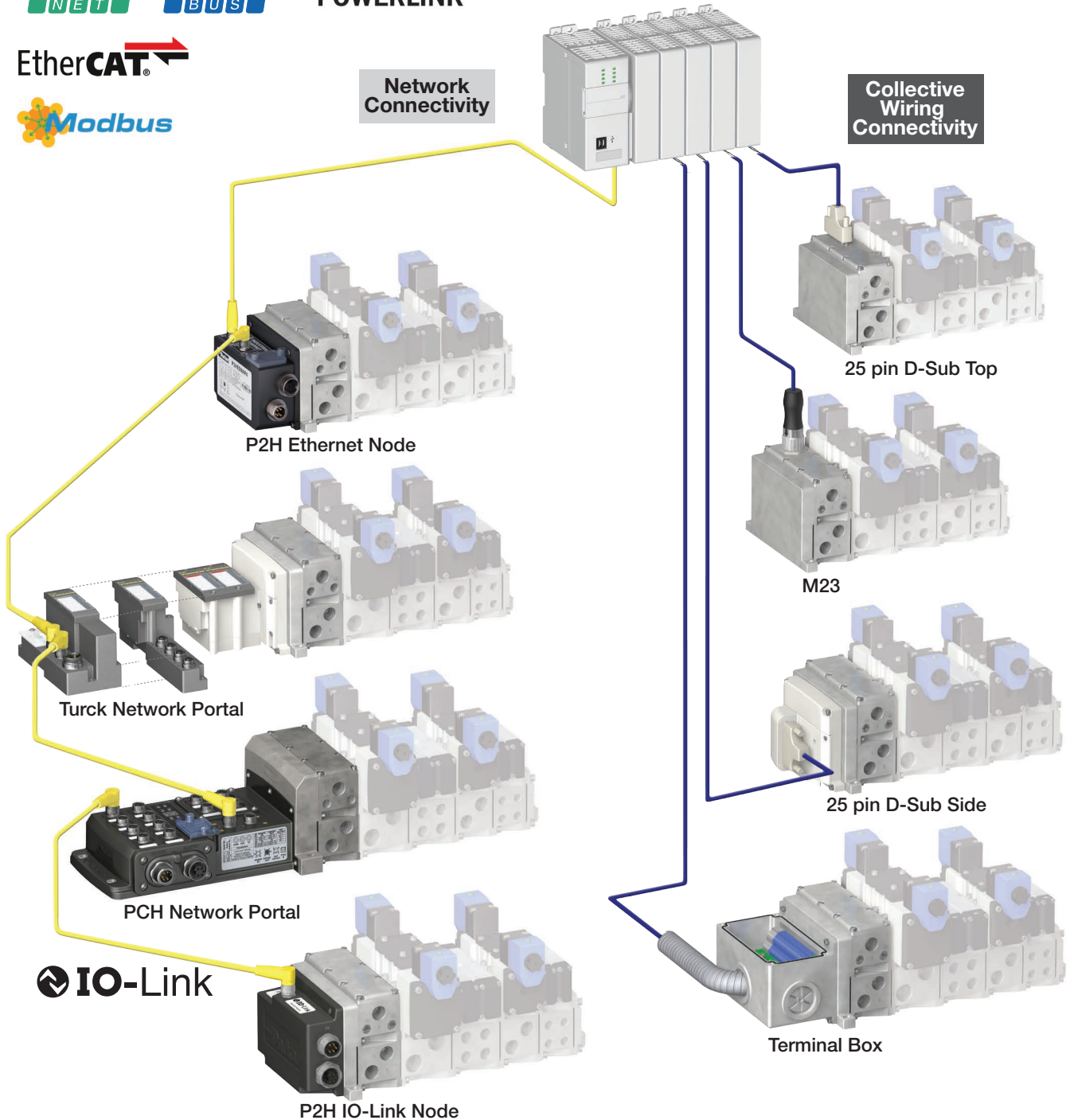

D
Subbase & Manual Valves
H Series Micro
Moduflex Series
H Series ISO
Network Connectivity
DX ISOMAX Series
Valvair II Series

Industrial Ethernet protocol offerings differ by product line



For inventory, lead times, and kit lookup, visit www.pdnplu.com

D75

Parker Hannifin Corporation
 Pneumatic Division
 Richland, Michigan
www.parker.com/pneumatics

Features

Two easy ways to order H Universal

1 Online Configuration

Navigate to the landing page
www.parker.com/pdn/HSeriesISO
Customize your manifold assembly
Create and save a unique assembled part number
Generate a CAD model

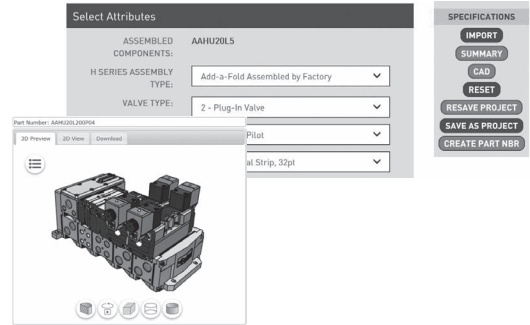

OR

2 Order Components

A Select Endplate Kit
Includes Left and Right Hand Endplate

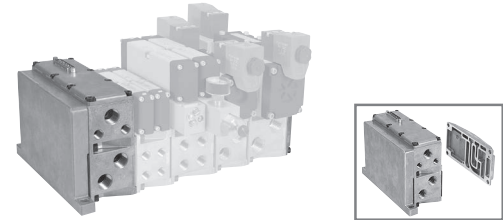

B Select Valve Stations
Valves (size HB, HA, H1 or H2)
Blanking Plate

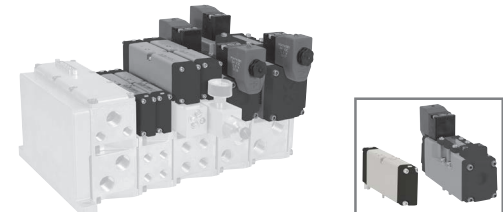

C Select Valve Manifold Segments
Manifold (size HB, HA, H1 or H2)
Air Supply Module

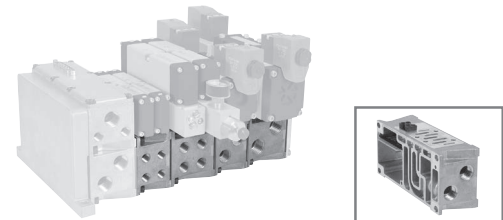

D Select Sandwich Accessories
Sandwich Regulators
Sandwich Flow Control
Pilot Exhaust

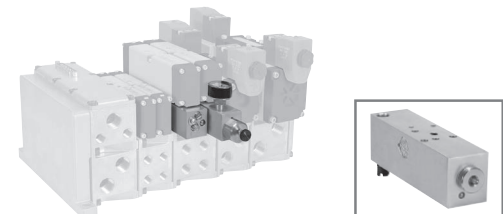











D	Subbase & Manual Valves
	H Series Micro
	Modulflex Series
	H Series ISO
	Network Connectivity
	DX ISOMAX Series
	Valvair II Series

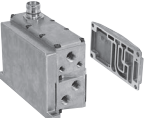

For inventory, lead times, and kit lookup, visit www.pdnplu.com

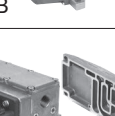
Common Part Numbers

End Plate Kits - Universal for use with HB, HA, H1 H2

	Electrical option	NPT port	BSPP port
	25-pin, D-Sub Side, 24 address	PSHU20L100P	PSHU20L101P
	25-pin, D-Sub Top, 24 address	PSHU20L200P	PSHU20L201P
	19-pin, round, Brad Harrison, 16 address	PSHU20L300P	PSHU20L301P
	12-pin, M23, 8 address	PSHU20L400P	PSHU20L401P
	19-pin, M23, 16 address	PSHU20M200P	PSHU20M201P
	Terminal box, 32 address	PSHU20L500P	PSHU20L501P
<div style="display: flex; flex-direction: column; align-items: flex-start;"> <div style="margin-bottom: 10px;"></div> <div style="margin-bottom: 10px;"></div> <div style="margin-bottom: 10px;"></div> <div></div> </div> <p>Class A</p> <p>Class B</p>	P2H IO Link Class B, standard version, 24 address	PSHU20N200P	PSHU20N201P
	P2H IO Link Class B, safe version, 24 address	PSHU20S200P	PSHU20S201P
	P2H IO Link Class A, 4-pin safe version, 24 address	PSHU20S400P	PSHU20S401P
	P2H IO Link Class A, 5-pin safe version, 24 address	PSHU20S500P	PSHU20S501P
	P2H Ethernet Node, 32 addresses, EtherNet/ IP™	PSHU20P200PE000A-P4	PSHU20P210PE000A-P4
	P2H Ethernet Node, 32 addresses, EtherCAT	PSHU20P200PT000A-P4	PSHU20P210PT000A-P4
	P2H Ethernet Node, 32 addresses, Profinet	PSHU20P200PN000A-P4	PSHU20P210PN000A-P4
	PCH Network Portal, 32 addresses with 2 Modules Variants, EtherNet/IP™	PSHU20P300PEAAN0-P4	PSHU20P301PEAAN0-P4
	PCH Network Portal, 32 addresses, with Modules Variants, EtherNet/IP™	PSHU20P300PEAAB0-P5	PSHU20P301PEAAB0-P5
	Turck Network with valve driver module, 16 address	PSHU20T100P	PSHU20T101P
	Turck Network with valve driver module, 32 address	PSHU20T200P	PSHU20T201P

 Most popular.



For inventory, lead times, and kit lookup, visit www.pdnplu.com

D77

Parker Hannifin Corporation
Pneumatic Division
Richland, Michigan
www.parker.com/pneumatics

D

Subbase & Manual Valves

H Series Micro

Modulflex Series

H Series ISO





Network Connectivity

DX ISOMAX Series

Valvair II Series

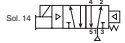
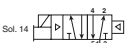
Common Part Numbers

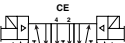
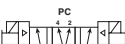
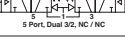



Valve - 15407-2, Plug-in, Size 18mm (HB)

Symbol	Type	Cv	Operator	Voltage	Pilot	Non-Locking	Locking						
	4-way, 2-position, spring return	0.55	Single solenoid	24 VDC	Internal	HBEVXBG0G9A	HBEVXBH0G9A						
					External	HBEVXLG0G9A	HBEVXLH0G9A						
						4-way, 2-position, air return	0.55	Single solenoid	24 VDC	Internal	HB1VXBG0G9A	HB1VXBH0G9A	
										External	HB1VXLG0G9A	HB1VXLH0G9A	
										120 VAC	Internal	HB1VXBG023A	HB1VXBH023A
											External	HB1VXLG023A	HB1VXLH023A
	4-way, 2-position	0.55	Double solenoid	24 VDC	Internal	HB2VXBG0G9A	HB2VXBH0G9A						
					External	HB2VXLG0G9A	HB2VXLH0G9A						
					120 VAC	Internal	HB2VXBG023A	HB2VXBH023A					
						External	HB2VXLG023A	HB2VXLH023A					
							4-way, 3-position, all ports blocked	0.5	Double solenoid	24 VDC	Internal	HB5VXBG0G9A	HB5VXBH0G9A
											External	HB5VXLG0G9A	HB5VXLH0G9A
120 VAC	Internal	HB5VXBG023A	HB5VXBH023A										
	External	HB5VXLG023A	HB5VXLH023A										
		4-way, 3-position, center exhaust	0.5	Double solenoid	24 VDC						Internal	HB6VXBG0G9A	HB6VXBH0G9A
											External	HB6VXLG0G9A	HB6VXLH0G9A
120 VAC						Internal	HB6VXBG023A	HB6VXBH023A					
						External	HB6VXLG023A	HB6VXLH023A					
							4-way, 3-position, pressure center	0.5	Double solenoid	24 VDC	Internal	HB7VXBG0G9A	HB7VXBH0G9A
											External	HB7VXLG0G9A	HB7VXLH0G9A
120 VAC	Internal	HB7VXBG023A	HB7VXBH023A										
	External	HB7VXLG023A	HB7VXLH023A										
		3-way, 2-position, dual valve, NC/NC	0.45	Double solenoid	24 VDC						Internal	HBNVXBG0G9A	HBNVXBH0G9A
											120 VAC	Internal	HBNVXBG023A
						3-way, 2-position, dual valve, NO/NO	0.45	Double solenoid	24 VDC	Internal	HBPVXBG0G9A	HBPVXBH0G9A	
										120 VAC	Internal	HBPVXBG023A	HBPVXBH023A

Manifold Base - 2-Station, 15407-2, Plug-in, Size 18mm (HB)

End Ported Bases	Enclosure / Lead Length	Solenoid Addresses	1/8" NPT	1/8" BSPP
	Circuit board	Single solenoid - 2 address	PSHU1151J1P	PSHU1152J1P
	Circuit board	Double solenoid - 4 addresses	PSHU1151M1P	PSHU1152M1P

Accessories - 15407-2, Plug-in, Size 18mm (HB)

Accessories	Description	Part Number
	Gauge adapter kit Includes 1/8" coupling, long nipple, and gauge	PS5651160P
	Blanking plate kit	PS5634P
	Sandwich flow control for individual valve Note: Do not use with Independent sandwich regulators	PS5635P
	Sandwich supply module	1/8" NPT PS561600P
		1/8" BSPP PS561601P
	Sandwich regulator	Common pressure PS5638155P
		Independent pressure PS5638255P
		2-60 PSIG w/ gauge PS5638166P
		5-125 PSIG w/ gauge PS5638266P

 Most popular.



For inventory, lead times, and kit lookup, visit www.pdnplu.com

D78

Parker Hannifin Corporation
 Pneumatic Division
 Richland, Michigan
www.parker.com/pneumatics

D
 Subbase & Manual Valves
 H Series Micro
 Modflex Series
 H Series ISO
 Network Connectivity
 DX ISOMAX Series
 Valvair II Series

Common Part Numbers

Valve - 15407-2, Plug-in, Size 26mm (HA)

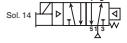
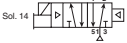
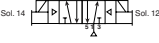
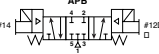
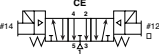
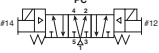
Symbol	Type	Cv	Operator	Voltage	Pilot	Non-Locking	Locking						
	4-way, 2-position, spring return	1.1	Single solenoid	24 VDC	Internal	HAEVXBG0G9A	HAEVXBH0G9A						
					External	HAEVXLG0G9A	HAEVXLH0G9A						
						4-way, 2-position, air return	1.1	Single solenoid	24 VDC	Internal	HA1VXBG0G9A	HA1VXBH0G9A	
										External	HA1VXLG0G9A	HA1VXLH0G9A	
										120 VAC	Internal	HA1VXBG023A	HA1VXBH023A
											External	HA1VXLG023A	HA1VXLH023A
	4-way, 2-position	1.1	Double solenoid	24 VDC	Internal	HA2VXBG0G9A	HA2VXBH0G9A						
					External	HA2VXLG0G9A	HA2VXLH0G9A						
					120 VAC	Internal	HA2VXBG023A	HA2VXBH023A					
						External	HA2VXLG023A	HA2VXLH023A					
							4-way, 3-position, all ports blocked	1.0	Double solenoid	24 VDC	Internal	HA5VXBG0G9A	HA5VXBH0G9A
											External	HA5VXLG0G9A	HA5VXLH0G9A
120 VAC	Internal	HA5VXBG023A	HA5VXBH023A										
	External	HA5VXLG023A	HA5VXLH023A										
		4-way, 3-position, center exhaust	1.0	Double solenoid	24 VDC						Internal	HA6VXBG0G9A	HA6VXBH0G9A
											External	HA6VXLG0G9A	HA6VXLH0G9A
120 VAC						Internal	HA6VXBG023A	HA6VXBH023A					
						External	HA6VXLG023A	HA6VXLH023A					
							4-way, 3-position, pressure center	1.0	Double solenoid	24 VDC	Internal	HA7VXBG0G9A	HA7VXBH0G9A
											External	HA7VXLG0G9A	HA7VXLH0G9A
120 VAC	Internal	HA7VXBG023A	HA7VXBH023A										
	External	HA7VXLG023A	HA7VXLH023A										





Single Subbase - 15407-2, Plug-in, Size 26mm (HA)

Enclosure / Lead Length	Solenoid Addresses	1/4" NPT	1/4" BSPP
 Terminal strip in the base	Double solenoid - 2 addresses	PS551113CP	PS551114CP

Manifold Base - 2-Station, 15407-2, Plug-in, Size 26mm (HA)

End Ported Bases	Enclosure / Lead Length	Solenoid Addresses	1/4" NPT	1/4" BSPP
	Circuit board	Single solenoid - 2 address	PSHU1153J1P	PSHU1154J1P
	Circuit board	Double solenoid - 4 addresses	PSHU1153M1P	PSHU1154M1P

Accessories - 15407-2, Plug-in, Size 26mm (HA)

Accessories	Description	Part Number	
	Blanking plate kit	PS5534P	
	Sandwich flow control for individual valve Note : Do not use with Independent Port Sandwich Regulators	PS5535P	
	Pilot pressure control, without sensor, 1/8" BSPP	PS55XXA0P	
	Sandwich supply module	1/4" NPT	PS552600P
		1/4" BSPP	PS552601P
	Sandwich regulator	2-60 PSIG w/ gauge	PS5538155P
		5-125 PSIG w/ gauge	PS5538166P

 Most popular.



For inventory, lead times, and kit lookup, visit www.pdnplu.com

D79

Parker Hannifin Corporation
 Pneumatic Division
 Richland, Michigan
www.parker.com/pneumatics

D

Subbase & Manual Valves

H Series Micro

Modulflex Series

H Series ISO





Network Connectivity

DX ISOMAX Series

Valvair II Series

Common Part Numbers

Valve - 5599-2, Plug-in, Size 1 (H1)

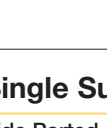
Symbol	Type	Cv	Operator	Voltage	Pilot	Non-Locking	Locking				
	Sol. 14 4-way, 2-position, spring return	1.5	Single solenoid	24 VDC	Internal	H1EVXBG0B9D	H1EVXBH0B9D				
					External	H1EVXXG0B9D	H1EVXXH0B9D				
					Internal	H1EVXBG023D	H1EVXBH023D				
					External	H1EVXXG023D	H1EVXXH023D				
	Sol. 14 4-way, 2-position, air return	1.5	Single solenoid	24 VDC	Internal	H11VXBG0B9D	H11VXBH0B9D				
					External	H11VXXG0B9D	H11VXXH0B9D				
					Internal	H11VXBG023D	H11VXBH023D				
					External	H11VXXG023D	H11VXXH023D				
	Sol. 14 4-way, 2-position	1.5	Double solenoid	24 VDC	Internal	H12VXBG0B9D	H12VXBH0B9D				
					External	H12VXXG0B9D	H12VXXH0B9D				
					Internal	H12VXBG023D	H12VXBH023D				
				120 VAC	External	H12VXXG023D	H12VXXH023D				
						1.2	Double solenoid	24 VDC	Internal	H15VXBG0B9D	H15VXBH0B9D
									External	H15VXXG0B9D	H15VXXH0B9D
Internal	H15VXBG023D	H15VXBH023D									
120 VAC	External	H15VXXG023D	H15VXXH023D								
		1.2	Double solenoid	24 VDC				Internal	H16VXBG0B9D	H16VXBH0B9D	
								External	H16VXXG0B9D	H16VXXH0B9D	
Internal					H16VXBG023D	H16VXBH023D					
120 VAC				External	H16VXXG023D	H16VXXH023D					
					1.2	Double solenoid	24 VDC	Internal	H17VXBG0B9D	H17VXBH0B9D	
								External	H17VXXG0B9D	H17VXXH0B9D	
Internal	H17VXBG023D	H17VXBH023D									
120 VAC	External	H17VXXG023D	H17VXXH023D								



Single Subbase - 5599-2, Plug-in, Size 1 (H1)

Side Ported	Enclosure / Lead Length	Solenoid Addresses	3/8" NPT	3/8" BSPP
	Terminal strip in base	Double solenoid - 2 addresses	PS401115CDP	PS401116CDP
	6" flying leads	Double solenoid - 2 addresses	PS401115ADP	PS401116ADP
	4-pin, M12 micro connector in base, SAE / Ford wiring	Double solenoid - 2 addresses	PS4011158FDP	PS4011168FDP

Manifold Base - 5599-2, Plug-in, Size 1 (H1)

End Ported	Enclosure / Lead Length	Solenoid Addresses	3/8" NPT	3/8" BSPP
	Circuit board	Single solenoid - 1 address	PSHU1155J1P	PSHU1156J1P
	Circuit board	Double solenoid - 2 addresses	PSHU1155M1P	PSHU1156M1P

Accessories - 5599-2, Size 1 (H1)

Accessory	Description	Part Number
	Common pressure	5-125 PSIG w/ gauge PS4038166CP
	Independent pressure	5-125 PSIG w/ gauge PS4038266CP
	Blanking plate kit	PS4034CP
	Sandwich flow control	PS4035CP

A Sandwich Flow Control and Common Port Sandwich Regulator may be used together on a manifold or subbase. The Sandwich Flow Control MUST be located between the manifold/subbase and the Common Port Sandwich Regulator. Do not use with Independent Port Sandwich Regulators.

 Most popular.



For inventory, lead times, and kit lookup, visit www.pdnplu.com









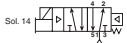

D80

Parker Hannifin Corporation
 Pneumatic Division
 Richland, Michigan
www.parker.com/pneumatics

D
 Subbase & Manual Valves
 H Series Micro
 Modulflex Series
 H Series ISO
 Network Connectivity
 DX ISOMAX Series
 Valvair II Series

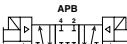
Common Part Numbers

Valve - 5599-2, Plug-in, Size 2 (H2)

Symbol	Type	Cv	Operator	Voltage	Pilot	Non-Locking	Locking		
 	4-way, 2-position, spring return	3.0	Single solenoid	24 VDC	Internal	H2EVXBG0B9D	H2EVXBH0B9D		
					External	H2EVXXG0B9D	H2EVXXH0B9D		
					120 VAC	Internal	H2EVXBG023D	H2EVXBH023D	
						External	H2EVXXG023D	H2EVXXH023D	
						24 VDC	Internal	H21VXBG0B9D	H21VXBH0B9D
							External	H21VXXG0B9D	H21VXXH0B9D
120 VAC	Internal	H21VXBG023D	H21VXBH023D						
	External	H21VXXG023D	H21VXXH023D						
 	4-way, 2-position, air return	3.0	Single solenoid	24 VDC	Internal	H22VXBG0B9D	H22VXBH0B9D		
					External	H22VXXG0B9D	H22VXXH0B9D		
					120 VAC	Internal	H22VXBG023D	H22VXBH023D	
						External	H22VXXG023D	H22VXXH023D	
						24 VDC	Internal	H22VXBG0B9D	H22VXBH0B9D
							External	H22VXXG0B9D	H22VXXH0B9D
120 VAC	Internal	H22VXBG023D	H22VXBH023D						
	External	H22VXXG023D	H22VXXH023D						
 	4-way, 2-position	3.0	Double solenoid	24 VDC	Internal	H25VXBG0B9D	H25VXBH0B9D		
					External	H25VXXG0B9D	H25VXXH0B9D		
					120 VAC	Internal	H25VXBG023D	H25VXBH023D	
						External	H25VXXG023D	H25VXXH023D	
						24 VDC	Internal	H25VXBG0B9D	H25VXBH0B9D
							External	H25VXXG0B9D	H25VXXH0B9D
120 VAC	Internal	H25VXBG023D	H25VXBH023D						
	External	H25VXXG023D	H25VXXH023D						
 	4-way, 3-position, all ports blocked	2.8	Double solenoid	24 VDC	Internal	H26VXBG0B9D	H26VXBH0B9D		
					External	H26VXXG0B9D	H26VXXH0B9D		
					120 VAC	Internal	H26VXBG023D	H26VXBH023D	
						External	H26VXXG023D	H26VXXH023D	
						24 VDC	Internal	H26VXBG0B9D	H26VXBH0B9D
							External	H26VXXG0B9D	H26VXXH0B9D
120 VAC	Internal	H26VXBG023D	H26VXBH023D						
	External	H26VXXG023D	H26VXXH023D						
 	4-way, 3-position, center exhaust	2.8	Double solenoid	24 VDC	Internal	H27VXBG0B9D	H27VXBH0B9D		
					External	H27VXXG0B9D	H27VXXH0B9D		
					120 VAC	Internal	H27VXBG023D	H27VXBH023D	
						External	H27VXXG023D	H27VXXH023D	
						24 VDC	Internal	H27VXBG0B9D	H27VXBH0B9D
							External	H27VXXG0B9D	H27VXXH0B9D
120 VAC	Internal	H27VXBG023D	H27VXBH023D						
	External	H27VXXG023D	H27VXXH023D						



Single Subbase - 5599-2, Plug-in, Size 2 (H2)

Side Ported Base	Enclosure / Lead Length	Solenoid Addresses	1/2" NPT	1/2" BSPP
	Terminal strip in base	Double solenoid - 2 address	PS411117CCP	PS411118CCP
	6" flying leads	Double solenoid - 2 addresses	PS411117ACP	PS411118ACP

Manifold Base - 5599-2, Plug-in, Size 2 (H2)

End Ported	Enclosure / Lead Length	Solenoid Addresses	1/2" NPT	1/2" BSPP
	Circuit board	Single solenoid - 1 address	PSHU1157J1P	PSHU1158J1P
	Circuit board	Double solenoid - 2 addresses	PSHU1157M1P	PSHU1158M1P

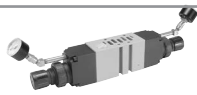
Accessories - 5599-2, Size 2 (H2)

Accessory	Description	Part Number
	Common pressure	PS4138166CP
	Independent pressure	PS4138266CP
	Blanking plate kit	PS4134CP
	Sandwich flow control	PS4135CP

A Sandwich Flow Control and Common Port Sandwich Regulator may be used together on a manifold or subbase. The Sandwich Flow Control MUST be located between the manifold/subbase and the Common Port Sandwich Regulator. Do not use with Independent Port Sandwich Regulators.

 Most popular.



For inventory, lead times, and kit lookup, visit www.pdnplu.com

D81

Parker Hannifin Corporation
Pneumatic Division
Richland, Michigan
www.parker.com/pneumatics

D

Subbase & Manual Valves

H Series Micro

Modulflex Series

H Series ISO

Network Connectivity

DX ISOMAX Series

Valvair II Series

Ordering Information

End Plate Kit - Universal Plug-in

PSHU20 L1 0 0 P

Valve Type	
Plug-in (internal pilot)	PSHU20
Plug-in (external pilot)	PSHU2X

Thread Type	
0	NPT
1*	BSPP "G"

* BSPP conforms to ISO 1179-1 w 228-1 threads

Left Hand End Plate Type * †	
25-Pin, D-Sub (side)	L1
25-Pin, D-Sub (top)	L2
19-Pin, Round, Brad Harrison	L3
12-Pin, M23	L4
32-Point Terminal Strip	L5
19-Pin, M23	M2
P2H IO Link Class B, 24 Address, Standard Version	N2
P2H IO Link Class B, 24 Address, Safe Version	S2
P2H IO Link Class A, 24 Address, 4-Pin, Safe Version	S4
P2H IO Link Class A, 24 Address, 5-Pin, Safe Version	S5
Turck Network with valve driver module - 16 outputs ‡	T1
Turck Network with valve driver module - 32 outputs ‡	T2
-----For P2H Ethernet Node and PCH Network Portal, see next pages -----	

Right Hand End Plate Type / Port	
0	Low Profile (no ports)
1	1/2 Exhaust and Inlet Port
2	3/4 Exhaust and Inlet Port
3*	H3 Transition Plate, 1" Exhaust and Inlet, (electrical pass through)
4*	H3 Transition Plate, 1" Exhaust and Inlet, (expansion to 25th address)

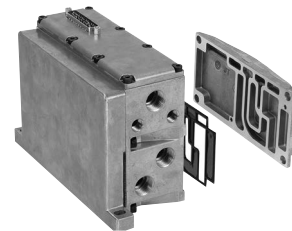

* 1, 3 & 5 manifold galley blocked at transition plate. 12 & 14 pass through.



25-pin D-Sub (top) with low profile end plate shown 3.97 Cv

- * 120VAC is not CSA certified.
- ‡ Turck Network communication modules must be ordered separately. See Network Connectivity section for more information.
- † PSHU11P gaskets included in each end plate kit.

Right Hand End Plate

	Description	NPT Port	BSPP Port
	Right hand end plate only, low profile, 3.97 Cv		PSHU4000P
	Right hand end plate only, high flow 1/2" ports, 6.07 Cv	PSHU4100P	PSHU4101P
	Right hand end plate only, high flow 3/4" ports, 8.35 Cv	PSHU4200P	PSHU4201P

H3 Transition Kit

	H3 transition, H3 right hand end plate, 1" ports, electrical pass through (includes gaskets & bolts)	PSHU7100P	PSHU7101P
	H3 transition, H3 right hand end plate, 1" ports, expansion to 25th address (includes gaskets & bolts)	PSHU7200P	PSHU7201P

Installation Bracket

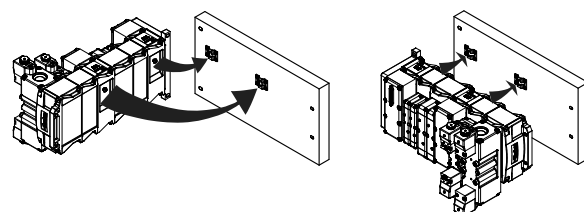

Bracket	Part Number
Bracket and Bolt (Quantity 2)	PSHU60P



For inventory, lead times, and kit lookup, visit www.pdnplu.com

D82

Parker Hannifin Corporation
Pneumatic Division
Richland, Michigan
www.parker.com/pneumatics

D
 Subbase & Manual Valves
 H Series Micro
 Modulflex Series
 H Series ISO
 Network Connectivity
 DX ISOMAX Series
 Valvair II Series

Ordering Information

End Plate Kit – Universal Plug-in

The P2H EtherNet Node is ordered as an endplate kit. This includes the P2H EtherNet Node, left hand air supply module, and right hand end plate. 32 pilot solenoid addresses with two choices of power source configurations.

For fully assembled manifold Add-A-Fold part number, reference page D91

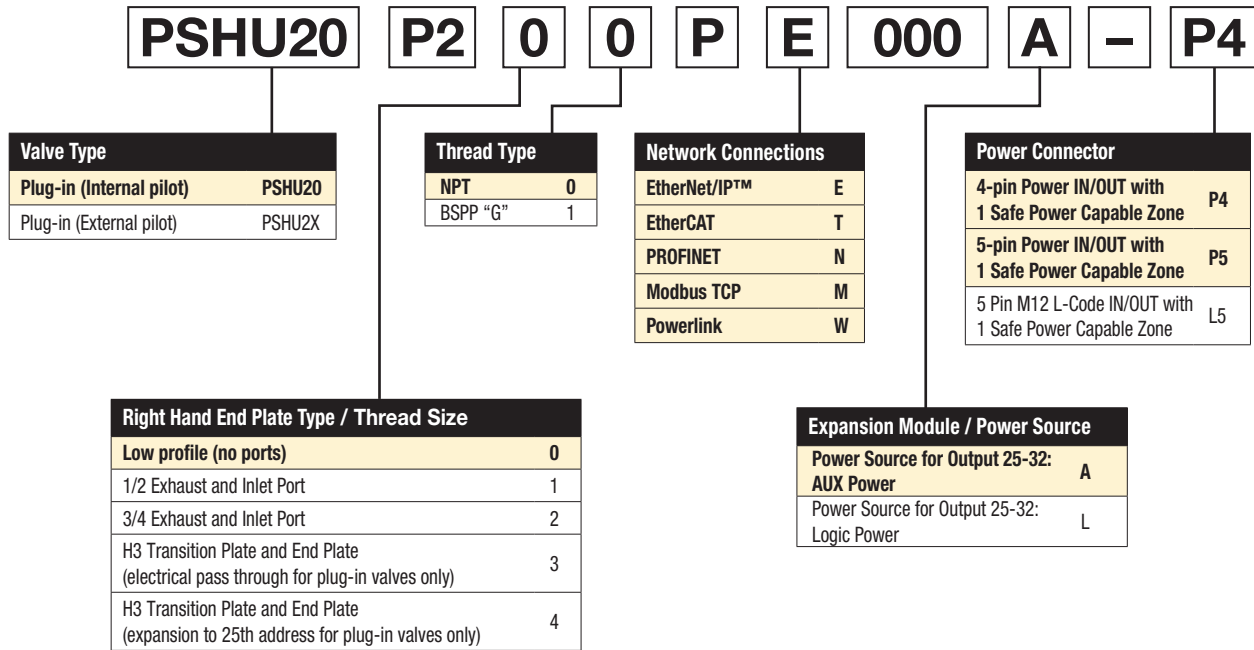
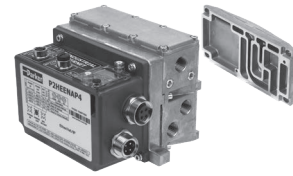

Power Source Selection

The P2H Node 32DO has two available power sources for addresses 24 to 31. Addresses 24 to 31 can draw their power from Auxiliary Power Pins (Power Source Option A) or Logic Power Pins (Power Source Option L). Must use Auxiliary Inlet Module with electrical expansion to access addresses 24 to 31. Address 0 to 23 is always auxiliary power source.

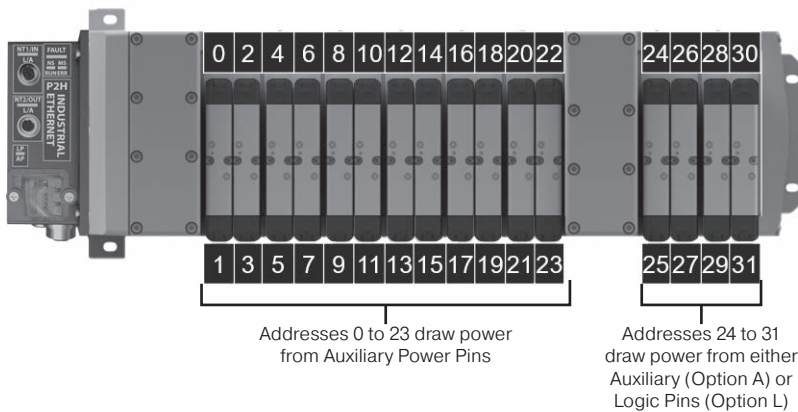

 Most popular.



For inventory, lead times, and kit lookup, visit www.pdnplu.com

D83

Parker Hannifin Corporation
Pneumatic Division
Richland, Michigan
www.parker.com/pneumatics

D

Subbase & Manual Valves

H Series Micro

Modulflex Series

H Series ISO

Network Connectivity

DX ISOMAX Series

Valvair II Series

Ordering Information

End Plate Kit – Universal Plug-in

The PCH Network Portal is ordered as an endplate kit. This includes the PCH Network Portal, left hand air supply module, and right hand end plate. 32 pilot solenoid addresses with configurable I/O.

For fully assembled manifold Add-A-Fold part number, reference page D92



PSHU20 P3 0 0 P E AAA 0 - P4

Valve Type	
Plug-in (Internal pilot)	PSHU20
Plug-in (External pilot)	PSHU2X

Thread Type	
NPT	0
BSPP "G"	1

Network Connections	
EtherNet/IP™	E
EtherCAT	T
PROFINET	N
Modbus TCP	M

Power Connector	
4-pin Power IN/OUT with 1 Safe Power Capable Zone	P4
5-pin Power IN/OUT with 1 Safe Power Capable Zone	P5
4-pin Power IN/IN with 2 Safe Power Zones	S4
5-pin Power IN/IN with 2 Safe Power Zones	S5

Right Hand End Plate Type / Thread Size	
Low profile (no ports)	0
1/2 Exhaust and Inlet Port	1
3/4 Exhaust and Inlet Port	2
H3 Transition Plate and End Plate (electrical pass through for plug-in valves only)	3
H3 Transition Plate and End Plate (expansion to 25th address for plug-in valves only)	4

Module Combinations		
Module Position 1	Module Position 2	Module Position 3
A	A	A
A	A	B
A	A	C
A	A	N
A	B	B
A	B	C
A	B	N
A	C	C
A	C	N
B	B	B
B	B	C
B	B	N
B	C	C
B	C	N
C	C	C
C	C	N

For any module configurations not listed, consult factory.

D	Subbase & Manual Valves
	H Series Micro
	Modulflex Series
	H Series ISO
	Network Connectivity
	DX ISOMAX Series
	Valvair II Series

Most popular.



For inventory, lead times, and kit lookup, visit www.pdnplu.com

Ordering Information

Valve - 15407-2 Plug-in, Size 18mm (HB) & 26mm (HA)

HB 1 VX B G 0 G9 A 8P

Basic Series 15407-2	
ISO 15407-2 18mm	HB
ISO 15407-2 26mm	HA

Options	
Blank	No Options
8P	M8, PNP, Spool Sensing
8N	M8, NPN, Spool Sensing
2P	M12, PNP, Spool Sensing

* Available on HA series with operator functions 1, 2, E only

15407-2 Operator / Function	
Single Solenoid, 2-Position - Air Return	1
Double Solenoid, 2-Position	2
Double Solenoid, 3-Position - APB	5
Double Solenoid, 3-Position - CE	6
Double Solenoid, 3-Position - PC	7
Single Solenoid, 2-Position - Air Return, Spring Assist	E
Double Solenoid, Dual 3/2, NC/NC	N*
Double Solenoid, Dual 3/2, NO/NO	P*
Double Solenoid, Dual 3/2, 14 End NC – 12 end NO	Q*

* Available on HB Only, must use Internal Pilot Source Option "B".

15407-2 Engineering Level	
A	Current

15407-2 Voltage & Frequency				
	AC		DC	Light & Surge Suppression
	60Hz	50Hz		
G9			24	LED & Suppression
23	120	115		LED & Suppression

Mounting	
15407-2 Valve Less Base	VX

15407-2 Enclosure / Lead Length	
0	Valve Less Base

15407-2 Pilot Source / Pilot Exhaust	
B	Internal Pilot, Port #1 / Vented
L*	External Pilot, Port #14 / Vented

* Must be specified when using Sandwich Regulators.

15407-2 Overrides / Lights	
G	Non-Locking, Flush, Push - W/ Light
H	Locking, Flush, Push / Turn - W/ Light

Part Number	Cable Type
RKC 4.4T-2	M12, 4 Pin Female, PVC, 2m
PKG 3M-4/ S90	M8, 3 Pin Female, PUR, 4M, flying lead



HB 18mm Valve shown

Valve - 5599-2 Plug-in, Size H1 & H2

H1 E VX B G 0 B9 D

Basic Series 5599-2	
ISO 5599-2 Size 1	H1
ISO 5599-2 Size 2	H2

5599-2 Engineering Level	
D	Current

5599-2 Operator / Function	
Single Solenoid, 2-Position - Air Return	1
Double Solenoid, 2-Position	2
Double Solenoid, 3-Position - APB	5
Double Solenoid, 3-Position - CE	6
Double Solenoid, 3-Position - PC	7
Single Solenoid, 2-Position - Air Return, Spring Assist	E

5599-2 Voltage & Frequency				
	AC		DC	Light & Surge Suppression
	60Hz	50Hz		
42	24			
45			12	
B9			24	LED & Suppression, 3.2 Watt
F9			24	LED & Suppression, 1.3 Watt
23	120	115		LED & Suppression
57*	240			

* Single subbase only. Not available for 5599-2 manifold mount.

5599-2 Mounting	
5599-2 Valve Less Base	VX

5599-2 Enclosure / Lead length	
0	None, valve less base

5599-2 Pilot Source / Pilot Exhaust	
B	Internal Pilot, Port #1 / Vented
X*	External Pilot, Port #12 Or #14 / Vented

* Must be specified when using Sandwich Regulators.

5599-2 Overrides / Lights		
	Voltage code	
B	42, 45, 57	Non-Locking, Flush, Push - w/o Light
C	42, 45, 57	Locking, Flush, Push / Turn - w/o Light
G	B9, F9, 23	Non-Locking, Flush, Push - w/ Light
H	B9, 23	Locking, Flush, Push / Turn - w/ Light



H1 Valve shown

Most popular.



For inventory, lead times, and kit lookup, visit www.pdnplu.com

D85

Parker Hannifin Corporation
Pneumatic Division
Richland, Michigan
www.parker.com/pneumatics

D

Subbase & Manual Valves

H Series Micro

Modulflex Series

H Series ISO

Network Connectivity

DX ISOMAX Series

Valvair II Series

Manifold Kit - Universal Plug-in

PSHU1153 J 1 P

Mounting Style / Port Size	
HB Manifold with 1/8 NPT End Ports	PSHU1151
HB Manifold with 1/8 BSPP End Ports	PSHU1152*
HA Manifold with 1/4 NPT End Ports	PSHU1153
HA Manifold with 1/4 BSPP End Ports	PSHU1154*
H1 Manifold with 3/8 NPT End Ports	PSHU1155
H1 Manifold with 3/8 BSPP End Ports	PSHU1156*
H2 Manifold with 1/2 NPT End Ports	PSHU1157
H2 Manifold with 1/2 BSPP End Ports	PSHU1158*

* BSPP conforms to ISO 1179-1 w 228-1 threads.

Gasket Options	
1	1,3,5 Ports Open And Pilots Open
2	1,3,5 Ports Closed And Pilots Open
3	1 Closed, 3,5 Ports Open And Pilots Open
4	1 Port Open, 3,5 Ports Closed And Pilots Open
5	1,3,5 Ports Open And Pilots Closed
6	1,3,5 Ports Closed And Pilots Closed
7	1 Closed, 3,5 Ports Open And Pilots Closed
8	1 Port Open, 3,5 Ports Closed And Pilots Closed

Circuit Board Address Configuration	
J	Interconnect, Single Address
M	Interconnect, Double Address



HA manifold shown

PSHU115A T 1 P

Mounting Style / Port Size	
Intermediate Air Supply, NPT / Internal Pilot	PSHU115A
Intermediate Air Supply, BSPP / Internal Pilot	PSHU115B*
Intermediate Air Supply, NPT / External Pilot	PSHU115C
Intermediate Air Supply, BSPP / External Pilot	PSHU115D*

* BSPP conforms to ISO 1179-1 w 228-1 threads.

Gasket Options	
1	1,3,5 Ports Open And Pilots Open
2	1,3,5 Ports Closed And Pilots Open
3	1 Closed, 3,5 Ports Open And Pilots Open
4	1 Port Open, 3,5 Ports Closed And Pilots Open
5	1,3,5 Ports Open And Pilots Closed
6	1,3,5 Ports Closed And Pilots Closed
7	1 Closed, 3,5 Ports Open And Pilots Closed
8	1 Port Open, 3,5 Ports Closed And Pilots Closed

Circuit Board Address Configuration	
T	With Electrical Pass Through
E	With Electrical Expansion To 25th Address



Intermediate air supply module shown

D
 Subbase & Manual Valves
 H Series Micro
 Modutrex Series
 H Series ISO
 Network Connectivity
 DX ISOMAX Series
 Valvair II Series



For inventory, lead times, and kit lookup, visit www.pdnplu.com

Pneumatic Zoning

Multiple pressure zones can be created by selecting alternative gaskets between individual manifold segments or an intermediate air supply module. These zones can be designed to meet different application and safety requirements on the machine. Inserting the PXM Pilot Exhaust Module into a one of these zones allows control of pilot pressure for the entire zone.

Gasket Kit - Universal Manifold to Manifold

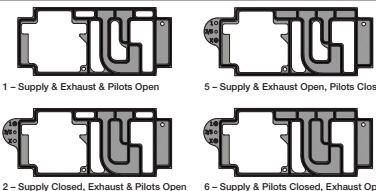
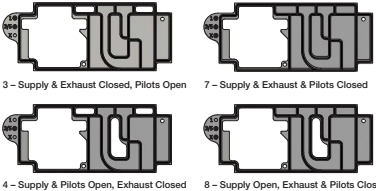
		Description	Part number
 <p>1 – Supply & Exhaust & Pilots Open 2 – Supply Closed, Exhaust & Pilots Open 3 – Supply & Exhaust Closed, Pilots Open 4 – Supply & Pilots Open, Exhaust Closed</p>	Pilots opened	1 – Supply & Exhaust & Pilots Open	PSHU11P
		2 – Supply Closed, Exhaust & Pilots Open	PSHU12P
		3 – Supply & Exhaust Closed, Pilots Open	PSHU13P
		4 – Supply & Pilots Open, Exhaust Closed	PSHU14P
 <p>5 – Supply & Exhaust Open, Pilots Closed 6 – Supply & Pilots Closed, Exhaust Open 7 – Supply & Exhaust & Pilots Closed 8 – Supply Open, Exhaust & Pilots Closed</p>	Pilots blocked	5 – Supply & Exhaust Open, Pilots Closed	PSHU15P
		6 – Supply & Pilots Closed, Exhaust Open	PSHU16P
		7 – Supply & Exhaust & Pilots Closed	PSHU17P
		8 – Supply Open, Exhaust & Pilots Closed	PSHU18P

Pilot Exhaust Module / HA Spool Sensing

PXM Pilot Exhaust Module enables an H Series HA Single Solenoid valve to control the pilot pressure to other externally piloted H Series ISO valves in the same manifold zone. The HA valve in conjunction with the PXM will remove pilot pressure to all externally piloted valves in the manifold zone when solenoid 14 is de-energized (off). Control of all externally piloted valves in the zone is disabled for both solenoid actuation and manual override until solenoid 14 of the HA valve on the PXM is energized again (on).

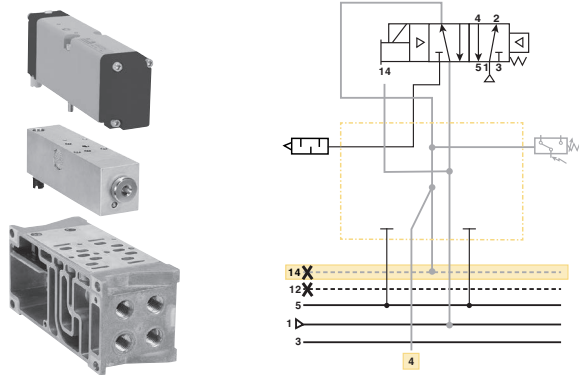

Alternatively, the HA Single Solenoid spool sensing valve can be used in place of the standard HA Valve. The spool sensing option mounts on top of the PXM and provides the added benefit of solid-state sensing of spool position to the PLC via an M8 or M12 connection. The spool sensing can be used without the PXM module for sensing only.

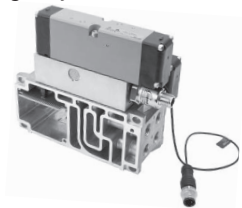
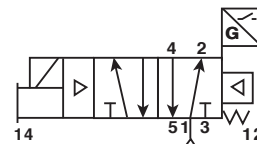

Gaskets blocking pilot pressure are required at the start of the zone the PXM is controlling. Special zoning gaskets (shown below) are available to meet any application requirement. In the example below, main pressure and exhaust pass through to the second zone, but pilot pressure is blocked. This results in the PXM providing pilot pressure for the zone after this gasket.

Part Number	Sensor Type
PS55XXA0P	No sensing
PS55XXM0P	Mechanical pressure switch
PS55XXE0P	Solid state pressure switch

Part Number	Cable Type
RKC 4.4T-2	M12, 4 Pin Female, PVC, 2m

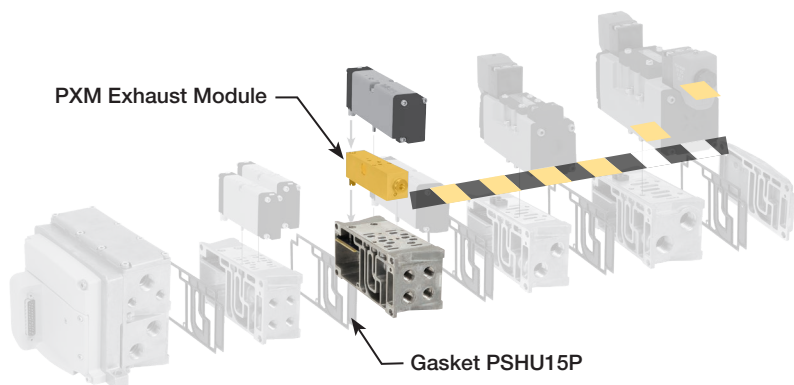

For inventory, lead times, and kit lookup, visit www.pdnplu.com

D87

Parker Hannifin Corporation
 Pneumatic Division
 Richland, Michigan
www.parker.com/pneumatics

D

Subbase & Manual Valves

H Series Micro

Modulflex Series

H Series ISO

Network Connectivity

DX ISO MAX Series

Valvair II Series

Sandwich Regulator - 15407-2, Plug-in,

PS5638 **1** **6** **6** **P**

Basic Series	
HB 15407-2, 18mm, Plug-in	PS5638
HA 15407-2, 26mm, Plug-in	PS5538

Regulator Function	
Common Pressure Regulator	1
Independent Pressure Regulator	2

#2 Port Regulator / Gauge*	
5	2-60 PSIG w/Gauge
6	5-125 PSIG w/Gauge

* For Common Pressure Regulator Option, Regulator Gauge callout must be the same number for both Port #4 and Port #2. (Example: 166)

#4 Port Regulator / Gauge*	
5	2-60 PSIG w/Gauge
6	5-125 PSIG w/Gauge

* For Common Pressure Regulator Option, Regulator Gauge callout must be the same number for both Port #4 and Port #2. (Example: 166)

Ordering Components

- Sandwich Regulator Kit configured for Internal Pilot as standard.
- Order valve as External Pilot.



HB - 18mm
(Independent Dual Port Regulator shown)



HA - 26mm
(Common Port Regulator shown)

How to Configure Sandwich Regulator / Valve Combinations

Internal Pilot Configuration of Sandwich Regulator HA, HB

Pressure in Base Port 1 feeds regulator configured for Internal Pilot which feeds valve configured for External Pilot.

Accessories	Description	Part number
 Gauge adapter kit	Includes 1/8" coupling, long nipple, and gauge	PS5651160P

Sandwich Regulator Cv Flow Chart*

	Common Pressure Code 166				Dual Pressure Code 266			
	1-2	1-4	2-3	4-5	1-2	1-4	2-3	4-5*
HB	0.20	0.20	0.41	0.34	0.23	0.19	0.28	0.27
HA	0.41	0.43	0.87	0.89	0.42	0.45	0.68	0.66

* Regulator Port exhaust through Base Port 3.
Note: All Cv's calculated with regulator adjusted full open.

 Most popular.



For inventory, lead times, and kit lookup, visit www.pdnplu.com

D88

Parker Hannifin Corporation
Pneumatic Division
Richland, Michigan
www.parker.com/pneumatics

D
 Subbase & Manual Valves
 H Series Micro
 Modulflex Series
 H Series ISO
 Network Connectivity
 DX ISOMAX Series
 Valvair II Series

Sandwich Regulator - 5599-2, Plug-in,

PS4038 1 6 6 C P

Basic Series	
H1 5599-2, Plug-in	PS4038
H2 5599-2, Plug-in	PS4138

Regulator Function	
Common Pressure Regulator	1
Independent Pressure Regulator	2

#2 Port Regulator / Gauge*	
0**	Line By-Pass Plate
4	1-30 PSIG w/Gauge
5	2-60 PSIG w/Gauge
6	5-125 PSIG w/Gauge
D	Remote Pilot ISO 2 & 3 only

* For Common Pressure Regulator Option, Regulator Gauge callout must be the same number for both Port #4 and Port #2. (Example: 166)

** Pressure Line By-Pass Option can only be used with Independent Pressure Regulators.

#4 Port Regulator / Gauge*	
0**	Line By-Pass Plate
4	1-30 PSIG w/Gauge
5	2-60 PSIG w/Gauge
6	5-125 PSIG w/Gauge
D	Remote Pilot ISO 2 & 3 only

* For Common Pressure Regulator Option, Regulator Gauge callout must be the same number for both Port #4 and Port #2. (Example: 166)

** Pressure Line By-Pass Option can only be used with Independent Pressure Regulators.

Ordering Components

- Sandwich Regulator Kit configured for Internal Pilot as standard.
- Order valve as External Pilot.



H1 - Size 1
 (Independent Dual Port Regulator shown)

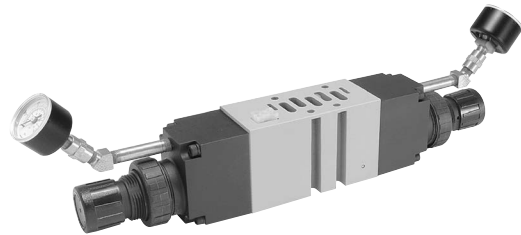

H2 - Size 2
 (Independent Dual Port Regulator shown)

How to Configure Sandwich Regulator / Valve Combinations

Internal Pilot Configuration of Sandwich Regulator H1, H2

Pressure in Base Port 1 feeds regulator configured for Internal Pilot which feeds valve configured for External Pilot.

External Pilot Configuration of Sandwich Regulator H1, H2

An External Pilot pressure in Port 12 or 14 of the base feeds thru the Sandwich Regulator 12 or 14 galley directly to the 12/14 pilot of the valve. This configuration takes an External Pilot from the 12 port of the base and passes it thru the regulator to feed the 12 galley of the valve.

Sandwich Regulator Cv Flow Chart*

	Common Pressure Code 166				Single Pressure 2 Code 206				Single Pressure 4 Code 260				Dual Pressure Code 266			
	1-2	1-4	2-3	4-5	1-2	1-4	2-3	4-5*	1-2	1-4	2-3	4-5*	1-2	1-4	2-3	4-5*
H1	0.62	0.61	1.28	1.18	0.73	0.96	0.96	0.93	0.34	0.70	0.94	0.98	0.52	0.48	0.86	0.88
H2	1.47	1.60	2.41	2.33	1.71	1.90	1.52	1.75	1.74	1.67	1.73	1.79	1.61	1.62	1.50	1.67

* Regulator Port exhaust through Base Port 3.

Note: All Cv's calculated with regulator adjusted full open.



For inventory, lead times, and kit lookup, visit www.pdnplu.com

D89

Parker Hannifin Corporation
 Pneumatic Division
 Richland, Michigan
www.parker.com/pneumatics

D

Subbase & Manual Valves

H Series Micro

Modulflex Series

H Series ISO

Network Connectivity

DX ISOMAX Series

Valvair II Series

Ordering Information

Online Configuration

Navigate to the landing page

www.parker.com/pdn/HSeriesISO

Customize your manifold assembly

Create and save a unique assembled part number

Generate a CAD model



Add-A-Fold - Universal Plug-in

AA HU20 L1 0 0 P 04

Valve Type	
Plug-in (internal)	AAHU20
Plug-in (external)	AAHU2X

Number of Segments	
01	↓
32	

Left Hand End Plate Type * †	
25-Pin, D-Sub (side)	L1
25-Pin, D-Sub (top)	L2
19-Pin, Round, Brad Harrison	L3
12-Pin, M23	L4
32-Point Terminal Strip	L5
19-Pin, M23	M2
P2H IO Link Class B, 24 Address, Standard Version	N2
P2H IO Link Class B, 24 Address, Safe Version	S2
P2H IO Link Class A, 24 Address, 4-Pin, Safe Version	S4
P2H IO Link Class A, 24 Address, 5-Pin, Safe Version	S5
Turck Network with valve driver module - 16 outputs ‡	T1
Turck Network with valve driver module - 32 outputs ‡	T2
-----For P2H Ethernet Node and PCH Network Portal, see next pages -----	

Thread Type	
0	NPT
1*	BSPP "G"

* BSPP Conforms to ISO 1179-1 w 228-1 Threads

Right Hand End Plate Type / Port	
0	Low profile (no ports)
1	1/2 Exhaust and inlet port
2	3/4 Exhaust and inlet port
3*	H3 Transition plate, 1" exhaust and inlet, (electrical pass through)
4*	H3 Transition plate, 1" exhaust and inlet, (expansion to 25th address)

* 1, 3 & 5 manifold galley blocked at transition plate. 12 & 14 pass through.

- * 120VAC is not CSA certified. Not available with 240VAC coils.
- ‡ Turck Network communication modules must be ordered separately. See Network Connectivity section for more information.
- † PSHU11P gaskets included in each end plate kit, galley ports 1, 2, 3, 12 & 14 Open.

Example

Application requires a 5 segment manifold.

Item	Part No.	Location
01	AAHUL200P05	
02	HB2VXBG0G9A	Segment 1
03	HB2VXBG0G9A	
04	PSHU1151M1P	Manifold base
05	HA1VXBG0G9A	Segment 2
06	HA2VXBG0G9A	
07	PSHU1153M1P	Manifold base
08	HA1VXBG0G9A	Segment 3
09	HA2VXBG0G9A	
10	PSHU1153M1P	Manifold base
11	H12VXBG0B9A	Segment 4
12	PSHU1155M1P	
13	H22VXBG0B9A	Segment 5
14	PSHU1157M1P	

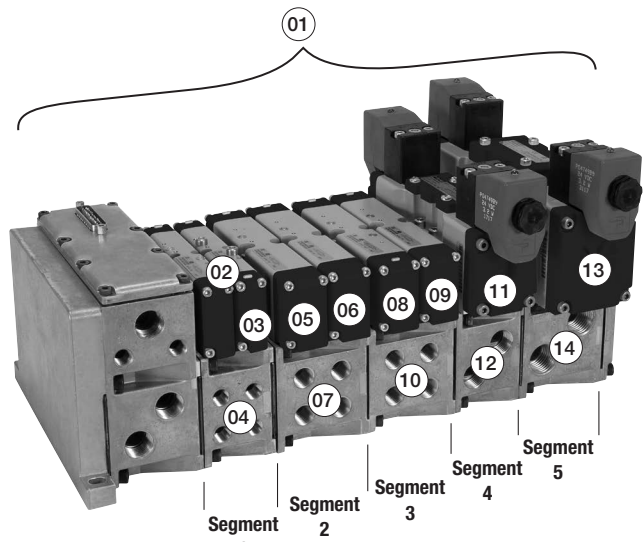

Example:
5 segment manifold with (2) HB, (4) HA, (1) H1, and (1) H2 valve on manifold bases with 25-pin, D-Sub end plate.

D

Subbase & Manual Valves

H Series Micro

Modulflex Series

H Series ISO

Network Connectivity

DX ISOMAX Series

Valvair II Series



For inventory, lead times, and kit lookup, visit www.pdnplu.com

D90

Parker Hannifin Corporation
Pneumatic Division
Richland, Michigan
www.parker.com/pneumatics

Ordering Information

Add-A-Fold – Universal Plug-in – P2H Ethernet Node

The P2H Industrial EtherNet node is a control unit capable of controlling up to 32 digital outputs (pilot solenoids), through the most popular Industrial Ethernet protocols. The P2H Ethernet is as a low-cost network connection with easy integration and simple to use diagnostics all housed in a robust IP65 weld-resistant housing.

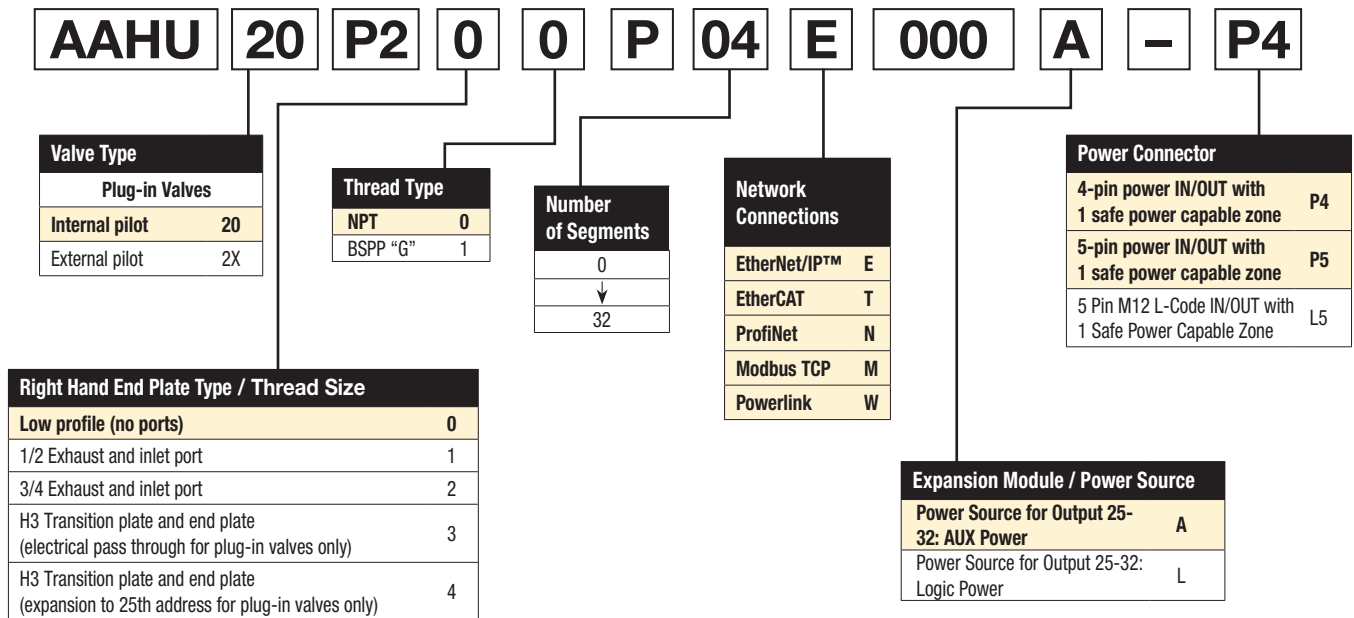
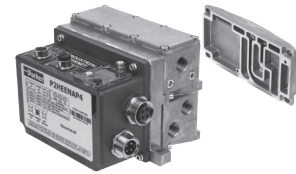

Example

Application required a 4 segment manifold

Item	Part No.	Location
01	AAHU20P200P04E000A-P4	
02	HB2VXBG0G9A	Valve Station 1
03	HB2VXBG0G9A	Segment 1 Valve Station 2
04	PSHU1151M1P	Manifold Base
05	HA1VXBG0G9A	Valve Station 3
06	HA2VXBG0G9A	Segment 2 Valve Station 4
07	PSHU1153M1P	Manifold Base
08	H12VXBG0B9A	Valve Station 5
09	PSHU1155M1P	Segment 3 Manifold Base
10	H2222VXBG0B9A	Valve Station 6
11	PSHU1157M1P	Segment 4 Manifold Base

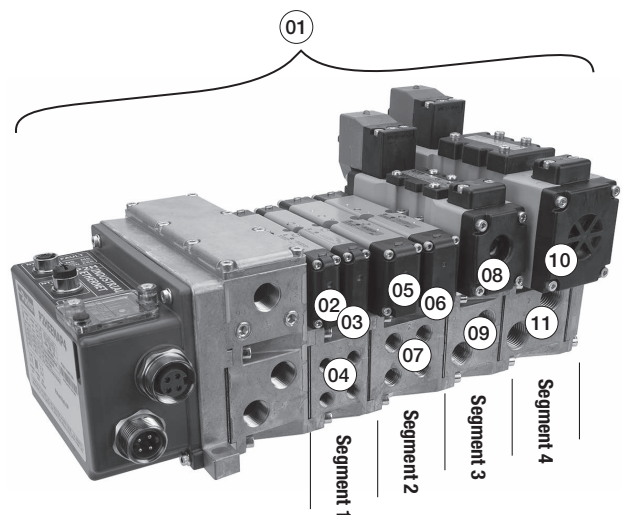

Example:
5 segment manifold with (2) HB, (2) HA, (1) H1, and (1) H2 valve on manifold bases with P2H Ethernet Node end plate.



For inventory, lead times, and kit lookup, visit www.pdnplu.com

Ordering Information

Add-A-Fold – Universal Plug-in – PCH Network Portal

The PCH Network Portal redefines and revolutionizes machine I/O (Inputs and Outputs). The PCH Portal was engineered for the open protocol IO-Link A and IO-Link B devices as well as configurable inputs/ outputs with true PNP/NPN circuitry switching on each port for easy machine design changes. The integrated configurability gives the user flexibility in designing I/O architecture. The PCH Network Portal is designed for general pneumatic control of industrial machinery on an Ethernet network for all types of automated industrial equipment.



AAHU 20 P3 0 0 P 04 E AAA 0 - P4

Valve Type	
Plug-in Valves	
Internal pilot	20
External pilot	2X

Thread Type	
NPT	0
BSPG "G"	1

Number of Segments	
	0
	↓
	32

Network Connections	
EtherNet/IP™	E
EtherCAT	T
ProfiNet	N
Modbus TCP	M

Module Combinations		
Module Position 1	Module Position 2	Module Position 3
A	A	A
A	A	B
A	A	C
A	A	N
A	B	B
A	B	C
A	B	N
A	C	C
A	C	N
B	B	B
B	B	C
B	B	N
B	C	C
B	C	N
C	C	C
C	C	N

Power Connector	
4-pin power IN/OUT with 1 safe power capable zone	P4
5-pin power IN/OUT with 1 safe power capable zone	P5
4-pin power IN/IN with 2 safe power zones	S4
5-pin power IN/IN with 2 safe power zones	S5

Right Hand End Plate Type / Thread Size	
Low profile (no ports)	0
1/2 Exhaust and inlet port	1
3/4 Exhaust and inlet port	2
H3 Transition plate and end plate (electrical pass through for plug-in valves only)	3
H3 Transition plate and end plate (expansion to 25th address for plug-in valves only)	4

For any module configurations not listed, consult factory.

Example

Application required a 4 segment manifold

Item	Part No.	Location
01	AAHU20P300P04EAAA0-P4	
02	HB2VXBG0G9A	Valve Station 1
03	HB2VXBG0G9A	Segment 1 Valve Station 2
04	PSHU1151M1P	Manifold Base
05	HA1VXBG0G9A	Valve Station 3
06	HA2VXBG0G9A	Segment 2 Valve Station 4
07	PSHU1153M1P	Manifold Base
08	H12VXBG0B9A	Segment 3 Valve Station 5
09	PSHU1155M1P	Manifold Base
10	H2222VXBG0B9A	Segment 4 Valve Station 6
11	PSHU1157M1P	Manifold Base

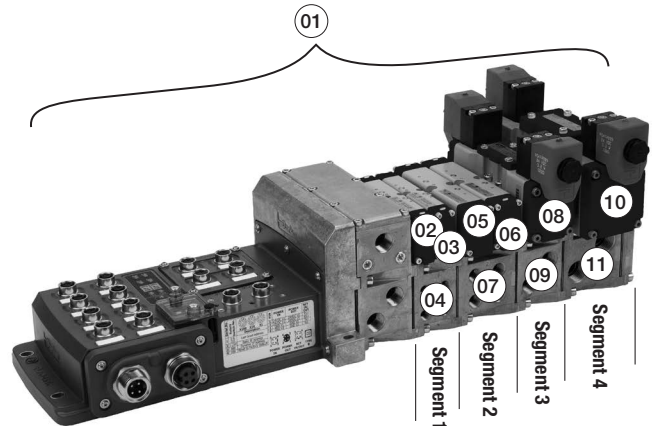

Example:
5 segment manifold with (2) HB, (2) HA, (1) H1, and (1) H2 valve on manifold bases with PCH Network Portal end plate.

D
 Subbase & Manual Valves
 H Series Micro
 Modflex Series
 H Series ISO
 Network Connectivity
 DX ISOMAX Series
 Valvair II Series



For inventory, lead times, and kit lookup, visit www.pdnplu.com

Subbase Kit - Plug-in

PS55 **1113** **C** **P**

Series	
HA Subbase	PS55
H1 Subbase	PS40
H2 Subbase	PS41

Engineering Level	
Blank	HA Series
D	H1 Series
C	H2 Series

Mounting Style / Port Size	
HA Series	
1/4 NPT side ports	1113
1/4 BSPP side ports	1114*
1/4 NPT bottom / side ports	1123
1/4 BSPP bottom / side ports	1124*
H1 Series	
3/8 NPT side ports	1115
3/8 BSPP side ports	1116*
H2 Series	
1/2 NPT side ports	1117
1/2 BSPP side ports	1118*

Wiring Options	
Blank	None
C ‡	Chrysler
F ‡	SAE / Ford
G ‡	General Motors

‡ Not available on HA series.

Enclosures / Lead Length	
Individually Wired Base*	
7 †	3-Pin mini connector in base
8 †	4-Pin M12 micro connector in base
9 †	5-Pin mini connector in base
A ‡	6" Leads
C	Terminal block

* Use plate with no connection.
 † Must specify valve auto wiring option "C", "F", or "G".
 ‡ Not available on HA series.

* BSPP conforms to ISO 1179-1 w 228-1 threads.













HA subbase shown

D
Subbase & Manual Valves
H Series Micro
Moduflex Series
H Series ISO
Network Connectivity
DX ISOMAX Series
Valvair II Series



Part Numbers

End Plate Kit - Plug-in, 5599-2, Size 3 (H3) * Not compatible with H Universal

Electrical option	NPT port	BSPP port
 No connector - use with individually wired base	PS4231010DP	PS4231011DP
 25-pin, D-sub	PS4220L20DP	PS4220L21DP
 19-pin, round, Brad Harrison	PS4220L30DP	PS4220L31DP
 12-pin, M23	PS4220L40DP	PS4220L41DP
 19-pin, M23	PS4220M20DP	PS4220M21DP
 Turck Network with valve driver module - 16 address	PS4220T10DP	PS4220T11DP
 Turck Network with valve driver module - 24 address	PS4220T20DP	PS4220T21DP
 P2H IO Link Class B, standard version, 24 address	PS4220N20DP	PS4220N21DP
 P2H IO Link Class B, safe version, 24 address	PS4220S20DP	PS4220S21DP
 P2H IO Link Class A, 4-pin safe version, 24 address	PS4220S40DP	PS4220S41DP
 P2H IO Link Class A, 5-pin safe version, 24 address	PS4220S50DP	PS4220S51DP

Turck Network, H Series Network, and P2M Network Node communication modules must be ordered separately. See Network Connectivity Section for more information.

Note:

For cable part numbers and pin out information see Network Connectivity Accessories.

D

Subbase & Manual Valves

H Series Micro

Modulflex Series

H Series ISO

Network Connectivity

DX ISOMAX Series

Valvair II Series





 Most popular.

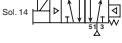
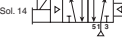

For inventory, lead times, and kit lookup, visit www.pdnplu.com

Common Part Numbers

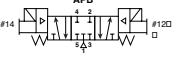
Valve - 5599-2, Plug-in, Size 3 (H3)

Symbol	Type	Cv	Operator	Voltage	Pilot	Non-locking	Locking						
	4-way, 2-position, spring return	6.0	Single solenoid	24 VDC	Internal	H3EVXBG0B9D	H3EVXBH0B9D						
					External	H3EVXXG0B9D	H3EVXXH0B9D						
						4-way, 2-position, air return	6.0	Single solenoid	24 VDC	Internal	H31VXBG0B9D	H31VXBH0B9D	
										External	H31VXXG0B9D	H31VXXH0B9D	
										120 VAC	Internal	H31VXBG023D	H31VXBH023D
											External	H31VXXG023D	H31VXXH023D
	4-way, 2-position	6.0	Double solenoid	24 VDC	Internal	H32VXBG0B9D	H32VXBH0B9D						
					External	H32VXXG0B9D	H32VXXH0B9D						
					120 VAC	Internal	H32VXBG023D	H32VXBH023D					
						External	H32VXXG023D	H32VXXH023D					
							4-way, 3-position, all ports blocked	5.0	Double solenoid	24 VDC	Internal	H35VXBG0B9D	H35VXBH0B9D
											External	H35VXXG0B9D	H35VXXH0B9D
120 VAC	Internal	H35VXBG023D	H35VXBH023D										
	External	H35VXXG023D	H35VXXH023D										
		4-way, 3-position, center exhaust	5.0	Double solenoid	24 VDC						Internal	H36VXBG0B9D	H36VXBH0B9D
											External	H36VXXG0B9D	H36VXXH0B9D
120 VAC						Internal	H36VXBG023D	H36VXBH023D					
						External	H36VXXG023D	H36VXXH023D					
							4-way, 3-position, pressure center	5.0	Double solenoid	24 VDC	Internal	H37VXBG0B9D	H37VXBH0B9D
											External	H37VXXG0B9D	H37VXXH0B9D
120 VAC	Internal	H37VXBG023D	H37VXBH023D										
	External	H37VXXG023D	H37VXXH023D										

Subbase - Single 5599-2, Plug-in, Size 3 (H3)

Side ported base	Enclosure / Lead length	Solenoid addresses	3/4" NPT	3/4" BSPP
	Terminal strip in base	Double solenoid - 2 address	PS421119CCP	PS421110CCP
	6" flying leads	Double solenoid - 2 addresses	PS421119ACP	PS421110ACP

Manifold Base - 5599-2, Plug-in, Size 3 (H3)

Bottom / End ported bases	Enclosure / Lead length	Solenoid addresses	3/4" NPT	3/4" BSPP
	Circuit board	Double solenoid - 2 addresses	PS421169MCP	PS421160MCP
	Terminal strip in base	Double solenoid - 2 address	PS421169CCP	PS421160CCP
	6" flying leads	Double solenoid - 2 addresses	PS421169ACP	PS421160ACP

End Ported	Enclosure / Lead length	Solenoid addresses	3/4" NPT	3/4" BSPP
	Circuit board	Double solenoid - 2 addresses	PS421159MCP	PS421150MCP
	Terminal strip in base	Double solenoid - 2 address	PS421159CCP	PS421150CCP
	6" flying leads	Double solenoid - 2 addresses	PS421159ACP	PS421150ACP

 Most popular.



For inventory, lead times, and kit lookup, visit www.pdnplu.com

D95

Parker Hannifin Corporation
 Pneumatic Division
 Richland, Michigan
www.parker.com/pneumatics

D

Subbase & Manual Valves

H Series Micro

Modulflex Series

H Series ISO





Network Connectivity

DX ISOMAX Series

Valvair II Series

Part Numbers

Accessories - 5599-2, Size 3 (H3)

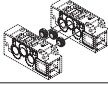
Accessory	Description	Part number
 <p>Sandwich regulator</p>	Common pressure 5-125 PSIG w/ gauge	PS4238166CP
	Independent pressure 5-125 PSIG w/ gauge	PS4238266CP
 <p>Blanking plate kit</p>		PS4234CP
 <p>Sandwich flow control</p> <p>A Sandwich Flow Control and Common Port Sandwich Regulator may be used together on a manifold or subbase. The Sandwich Flow Control MUST be located between the manifold/subbase and the Common Port Sandwich Regulator. Do not use with Independent Port Sandwich Regulators.</p>		PS4235CP
 <p>Manifold to manifold gasket kits</p>		PS4213P
 <p>Manifold isolation kit</p>	Main galley (1, 3, 5)	PS4232CP
	Pilot galley	PS4033CP

D

Subbase & Manual Valves

H Series Micro

Modulflex Series

H Series ISO

Network Connectivity

DX ISOMAX Series

Valvair II Series

 Most popular.



For inventory, lead times, and kit lookup, visit www.pdnplu.com

D96

Parker Hannifin Corporation
 Pneumatic Division
 Richland, Michigan
www.parker.com/pneumatics

Ordering Information

End Plate Kit - Plug-in, 5599-2, Size 3 (H3) * Not compatible with H Universal

PS42 **20L2** **0** **D** **P**

Basic Series	
ISO 5599, Size 3	PS42

Engineering Level	
D	Current

Options †	
25-Pin, D-Sub	20L2*
19-Pin, Round, Brad Harrison	20L3
12-Pin, M23	20L4
19-Pin, M23	20M2
P2H IO Link Class B, 24 Address, Standard Version	20N2
P2H IO Link Class B, 24 Address, Safe Version	20S2
P2H IO Link Class A, 24 Address, 4-Pin, Safe Version	20S4
P2H IO Link Class A, 24 Address, 5-Pin, Safe Version	20S5
Turck Network with Valve Driver Module - 16 Outputs	20T1
Turck Network with Valve Driver Module - 24 Outputs	20T2

Thread Type	
0	NPT
1*	BSPP "G"

* BSPP Conforms to ISO 1179-1 w 228-1 Threads

* 120VAC is Not CSA Rated.
 † Manifold bases must have a circuit board.
 Turck Network, communication modules must be ordered separately.
 See Network Connectivity Section for more information.

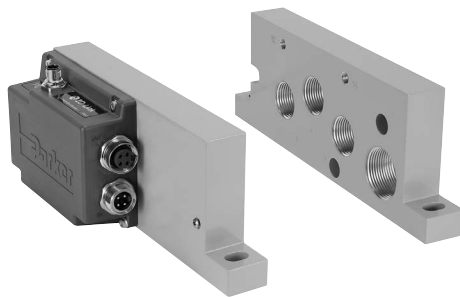

H3 P2H Class A end plate shown

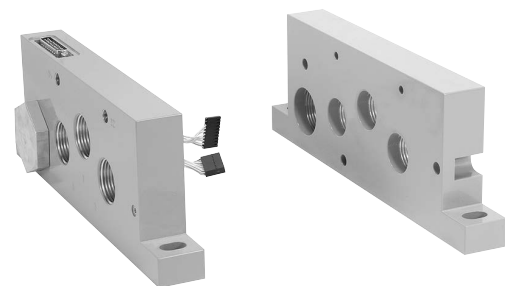

H3 25-pin D-Sub end plate shown

Most popular.



For inventory, lead times, and kit lookup, visit www.pdnplu.com

D97

Parker Hannifin Corporation
 Pneumatic Division
 Richland, Michigan
www.parker.com/pneumatics

D	Subbase & Manual Valves
	H Series Micro
	Moduflex Series
	H Series ISO
	Network Connectivity
	DX ISOMAX Series
	Valvair II Series

Valve - Plug-in, 5599-2, Size 3

H3 E VX B G O B9 D

Basic Series 5599-2
 ISO 5599-2 Size 3 H3

5599-2 Engineering Level
 D Current

5599-2 Operator / Function	
Single solenoid, 2-position - air return	1
Double solenoid, 2-position	2
Double solenoid, 3-position - APB	5
Double solenoid, 3-position - CE	6
Double solenoid, 3-position - PC	7
Single solenoid, 2-position - air return, spring assist	E

5599-2 Voltage & Frequency				
	AC		DC	Light & surge suppression
	60Hz	50Hz		
42	24			
45			12	
B9			24	LED & suppression, 3.2 watt
F9			24	LED & suppression, 1.3 watt
23	120	115		LED & suppression
57	240			

5599-2 Mounting
 5599-2 Valve less base VX

5599-2 Pilot source / Pilot exhaust
 Internal pilot, port #1 / vented B
 External pilot, port #12 or #14 / vented X*

* Must be specified when using Sandwich Regulators.

5599-2 Enclosure / Lead length
 0 None, valve less base

5599-2 Overrides / Lights		
	Voltage code	
B	42, 45, 57	Non-locking, flush, push - w/o light
C	42, 45, 57	Locking, flush, push / turn - w/o light
G	B9, F9, 23	Non-locking, flush, push - w/ light
H	B9, 23	Locking, flush, push / turn - w/ light

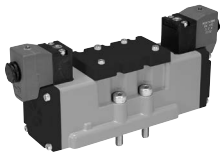

H3 Valve shown

- D**
- Subbase & Manual Valves
- H Series Micro
- Modulflex Series
- H Series ISO
- Network Connectivity
- DX ISOMAX Series
- Valvair-II Series

Most popular.



For inventory, lead times, and kit lookup, visit www.pdnplu.com

D98

Parker Hannifin Corporation
 Pneumatic Division
 Richland, Michigan
www.parker.com/pneumatics

Manifold / Subbase Kit - Plug-in, 5599-2, Size 3

PS421159 **M** **C** **P**

Mounting Base Style / Port Size	
Subbase: 3/4 NPT side port	PS421119
Subbase: 3/4 BSPP side port	PS421110*
Manifold: 3/4 NPT end port	PS421159
Manifold: 3/4 BSPP end port	PS421150*
Manifold: 3/4 NPT bottom / end port	PS421169
Manifold: 3/4 BSPP bottom / end port	PS421160*

* BSPP conforms to ISO 1179-1 w 228-1 threads.

Engineering Level	
C	H3

Wiring Options	
Blank	None
C	Chrysler
F	SAE / Ford
G	General Motors

Enclosures / Lead Length	
Individually Wired Base**	
7†	3-pin mini connector in base
8†	4-pin M12 micro connector in base
9†	5-pin mini connector in base
A	6" Leads
C	Terminal block
Collective Wired Base	
M*	Circuit board, double address

* Not available with subbase kits.

** Use plate with no connection.

† Must specify valve auto wiring option "C", "F", or "G".

Note:

When using the enclosure / lead length "M" option:

- 12VDC - Maximum number of coils energized simultaneously is 13
- 24VDC - Maximum number of coils energized simultaneously is 21, B9 coil
Maximum number of coils energized simultaneously is 24, F9 coil
- 120VAC - Coils limited by the number of pins available in the connector
(25-pin D-Sub = 24 coils, 19-pin Brad Harrison = 16, 12-pin M23 = 8)
- 240VAC - Must use "A" or "C" option, lead wires or terminal blocks

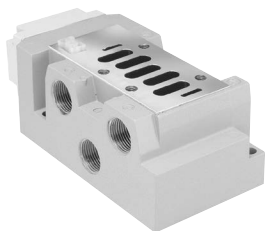

Subbase Kit

Automotive Connectors

Mounted in 1/2" Conduit Port

- 3-Pin - Wired for Single Solenoid
- 4-Pin / 5-Pin - Wired for Double Solenoid



Manifold Kit

Automotive Connectors

Mounted in Individual Manifold Conduit Cover

- 3-Pin - Wired for Single Solenoid
- 4-Pin / 5-Pin - Wired for Double Solenoid

Most popular.



For inventory, lead times, and kit lookup, visit www.pdnplu.com

D99

Parker Hannifin Corporation
Pneumatic Division
Richland, Michigan
www.parker.com/pneumatics

D
Subbase & Manual Valves
H Series Micro
Moduflex Series
H Series ISO
Network Connectivity
DX ISOMAX Series
Valvair II Series

Sandwich Regulator - Plug-in, 5599-2

PS4038 1 6 6 C P

Basic Series	
H3 5599-2, Plug-in	PS4238

Regulator Function	
Common Pressure Regulator	1
Independent Pressure Regulator	2

#2 Port Regulator / Gauge*	
0**	Line By-Pass Plate
4	1-30 PSIG w/Gauge
5	2-60 PSIG w/Gauge
6	5-125 PSIG w/Gauge
D	Remote Pilot ISO 2 & 3 only

* For Common Pressure Regulator Option, Regulator Gauge callout must be the same number for both Port #4 and Port #2. (Example: 166)

** Pressure Line By-Pass Option can only be used with Independent Pressure Regulators.

#4 Port Regulator / Gauge*	
0**	Line By-Pass Plate
4	1-30 PSIG w/Gauge
5	2-60 PSIG w/Gauge
6	5-125 PSIG w/Gauge
D	Remote Pilot ISO 2 & 3 only

* For Common Pressure Regulator Option, Regulator Gauge callout must be the same number for both Port #4 and Port #2. (Example: 166)

** Pressure Line By-Pass Option can only be used with Independent Pressure Regulators.

Ordering Components

- Sandwich Regulator Kit configured for Internal Pilot as standard.
- Order valve as External Pilot.

How to Configure Sandwich Regulator / Valve Combinations

Internal Pilot Configuration of Sandwich Regulator H3

Pressure in Base Port 1 feeds regulator configured for Internal Pilot which feeds valve configured for External Pilot.

External Pilot Configuration of Sandwich Regulator H3

An External Pilot pressure in Port 12 or 14 of the base feeds thru the Sandwich Regulator 12 or 14 galley directly to the 12/14 pilot of the valve. This configuration takes an External Pilot from the 12 port of the base and passes it thru the regulator to feed the 12 galley of the valve.

Sandwich Regulator Cv Flow Chart*

	Common Pressure Code 166				Single Pressure 2 Code 206				Single Pressure 4 Code 260				Dual Pressure Code 266			
	1-2	1-4	2-3	4-5	1-2	1-4	2-3	4-5*	1-2	1-4	2-3	4-5*	1-2	1-4	2-3	4-5*
H3	2.37	2.39	4.30	4.47	2.37	2.81	2.75	3.01	2.65	2.59	2.68	2.74	2.43	2.41	3.16	3.04

* Regulator Port exhaust through Base Port 3.
 Note: All Cv's calculated with regulator adjusted full open.

Most popular.



For inventory, lead times, and kit lookup, visit www.pdnplu.com

D100

Parker Hannifin Corporation
 Pneumatic Division
 Richland, Michigan
www.parker.com/pneumatics

D
 Subbase & Manual Valves
 H Series Micro
 Modutef Series
 H Series ISO
 Network Connectivity
 DX ISOMAX Series
 Valvair II Series

Add-A-Fold Assembly - Plug-in, 5599-2, Size 3 * Not compatible with H Universal

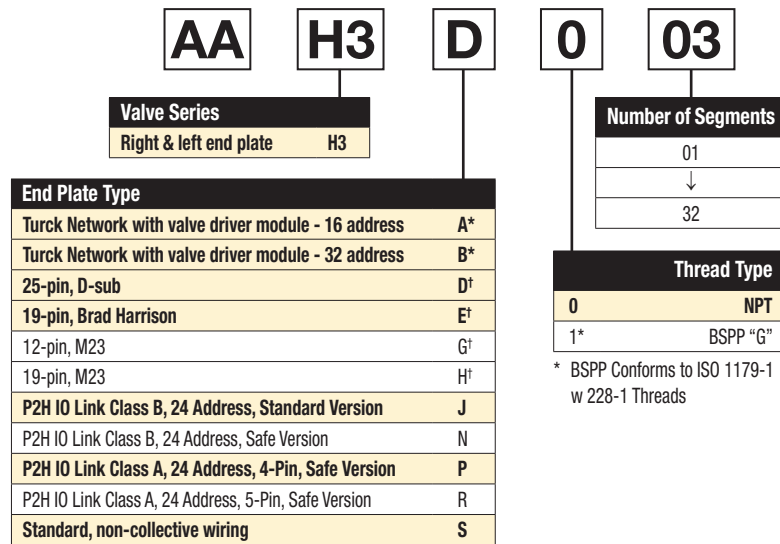

* Must order communication modules separately.
 † Collective wiring module included.

How To Order Plug-in Add-A-Fold Assemblies

1. List Add-A-Fold Assembly call out. This automatically includes the end plate kit assembly.
2. List complete valve, regulator, flow control and manifold base kit. List left to right, LOOKING AT THE CYLINDER PORTS on the #12 end of the manifold. The left most segment is segment 1. (If a blanking plate part number and the individual manifold part numbers for the required segment.)

Example

Application requires a 3 segment manifold and regulator on segment 3.

Item	Part No.	Location	
01	AAH3D003		
02	H31VXBG0B9D	Segment 1	Valve station 1
03	PS421159MCP		Manifold base
04	H32VXBG0B9D	Segment 2	Valve station 2
05	PS421159MCP		Manifold base
06	H32VXXG0B9D	Segment 3	Valve station 3
07	PS4238166CP		Sandwich regulator
08	PS421159MCP		Manifold base

NOTE: Construct manifold assemblies from left to right while looking at the cylinder ports.
 Valves must be ordered as External Pilot when using Sandwich Regulator.

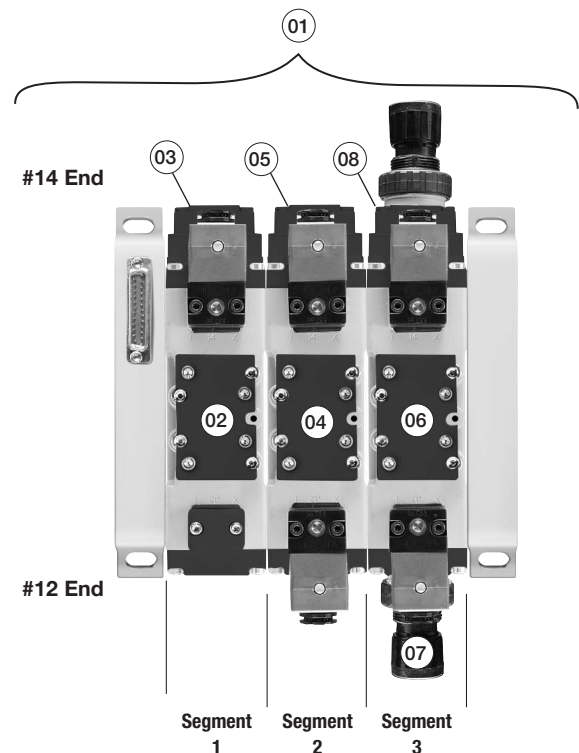

Example:
 3 segment manifold with (3) H3 valves on manifold bases and regulator at segment 3.

Most popular.



For inventory, lead times, and kit lookup, visit www.pdnplu.com

D101

Parker Hannifin Corporation
 Pneumatic Division
 Richland, Michigan
www.parker.com/pneumatics

D

Subbase & Manual Valves

H Series Micro

Modulflex Series

H Series ISO







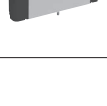

Network Connectivity

DX ISOMAX Series



Valvair II Series

Common Part Numbers





Valve -15407-1, Non Plug-in, Size 18mm (HB)

Symbol	Type	Cv	Operator	Voltage	Pilot	Non-locking	Locking
	4-way, 2-position, spring return	0.55	Single solenoid	24 VDC	Internal	HBEXXBG2G9000FA	HBEXXBH2G9000FA
					External	HBEXXLG2G9000FA	HBEXXLH2G9000FA
	4-way, 2-position, air return	0.55	Single solenoid	24 VDC	Internal	HB1WXBG2G9000FA	HB1WXBH2G9000FA
					External	HB1WXLG2G9000FA	HB1WXLH2G9000FA
	4-way, 2-position	0.55	Double solenoid	24 VDC	Internal	HB2WXBG2G9000FA	HB2WXBH2G9000FA
					External	HB2WXLG2G9000FA	HB2WXLH2G9000FA
	4-way, 3-position, all ports blocked	0.5	Double solenoid	24 VDC	Internal	HB5WXBG2G9000FA	HB5WXBH2G9000FA
					External	HB5WXLG2G9000FA	HB5WXLH2G9000FA
	4-way, 3-position, center exhaust	0.5	Double solenoid	24 VDC	Internal	HB6WXBG2G9000FA	HB6WXBH2G9000FA
					External	HB6WXLG2G9000FA	HB6WXLH2G9000FA
	4-way, 3-position, pressure center	0.5	Double solenoid	24 VDC	Internal	HB7WXBG2G9000FA	HB7WXBH2G9000FA
					External	HB7WXLG2G9000FA	HB7WXLH2G9000FA
	3-way, 2-position, dual valve, NC/NC	0.45	Double solenoid	24 VDC	Internal	HBNWXBG2G9000FA	HBNWXBH2G9000FA
					External	HB7WXLG2G9000FA	HB7WXLH2G9000FA
	3-way, 2-position, dual valve, NO/NO	0.45	Double solenoid	24 VDC	Internal	HBPWXBG2G9000FA	HBPWXBH2G9000FA
					External	HB7WXLG2G9000FA	HB7WXLH2G9000FA
	3-way, 2-position, dual valve, NC/NO	0.45	Double solenoid	24 VDC	Internal	HBQWXBG2G9000FA	NA
					External	HB7WXLG2G9000FA	HB7WXLH2G9000FA

Base / End Plate - 15407-1, Non Plug-in, Size 18mm (HB)

	Description	NPT	BSPP
	Universal manifold base 2 station, end ported	PSHU115101P	PSHU115201P
	Universal end plate Non-collective wiring	PSHU31L000P	PSHU31L001P

Accessories - 15407-1, Non plug-in, Size 18mm (HB)

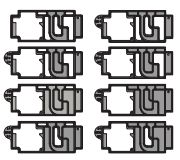
Accessories	Description	Part number		
	Gauge adapter kit Includes 1/8" coupling and long nipple	PS5651160P		
	Blanking plate kit	PS5634P		
	Sandwich flow control Do not use with Independent Port Sandwich Regulators.	PS5642P		
	Sandwich supply module 1/8" NPT 1/8" BSPP	PS562600P		
		PS562601P		
	Sandwich regulator 2-60 PSIG w/ gauge 5-125 PSIG w/ gauge	Common pressure	Independent pressure	
		PS5637155P	PS5637255P	
	Manifold to manifold gasket kits	Pilot open	Pilot blocked	
		#1, 3, 5 ports open	PSHU11P	PSHU15P
		Blocked #1 port	PSHU12P	PSHU16P
		Blocked #1, 3, 5, ports	PSHU13P	PSHU17P
	Blocked #3, 5 ports	PSHU14P	PSHU18P	

D
 Subbase & Manual Valves
 H Series Micro
 Modulflex Series
 H Series ISO
 Network Connectivity
 DX ISOMAX Series
 Valvair II Series





For inventory, lead times, and kit lookup, visit www.pdnplu.com

D102

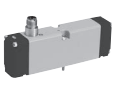
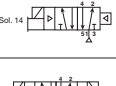
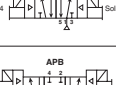
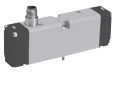

Parker Hannifin Corporation
Pneumatic Division
Richland, Michigan
www.parker.com/pneumatics

Common Part Numbers

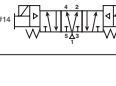

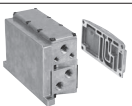

Valve - 15407-1, Non Plug-in, Size 26mm (HA)

Symbol	Type	Cv	Operator	Voltage	Pilot	Non-locking	Locking
	4-way, 2-position, spring return	1.1	Single solenoid	24 VDC	Internal	HAEWXBG2G9000FA	HAEWXBH2G9000FA
					External	HAEWXLG2G9000FA	HAEWXLH2G9000FA
	4-way, 2-position, air return	1.1	Single solenoid	24 VDC	Internal	HA1WXBG2G9000FA	HA1WXBH2G9000FA
					External	HA1WXLG2G9000FA	HA1WXLH2G9000FA
	4-way, 2-position	1.1	Double solenoid	24 VDC	Internal	HA2WXBG2G9000FA	HA2WXBH2G9000FA
					External	HA2WXLG2G9000FA	HA2WXLH2G9000FA
	4-way, 3-position, all ports blocked	1.0	Double solenoid	24 VDC	Internal	HA5WXBG2G9000FA	HA5WXBH2G9000FA
					External	HA5WXLG2G9000FA	HA5WXLH2G9000FA
	4-way, 3-position, center exhaust	1.0	Double solenoid	24 VDC	Internal	HA6WXBG2G9000FA	HA6WXBH2G9000FA
					External	HA6WXLG2G9000FA	HA6WXLH2G9000FA
	4-way, 3-position, pressure center	1.0	Double solenoid	24 VDC	Internal	HA7WXBG2G9000FA	HA7WXBH2G9000FA
					External	HA7WXLG2G9000FA	HA7WXLH2G9000FA

Base / End Plate - 15407-1, Non Plug-in, Size 26mm (HA)

	Description	NPT	BSPP
	Single subbase	Side ported base, 1/4" port	PS5511130P / PS5511140P
	Universal manifold base	2 station, end ported	PSHU115301P / PSHU115401P
	Universal end plate	Non-collective wiring	PSHU31L000P / PSHU31L001P

Accessories - 15407-1, Non Plug-in, Size 26mm (HA)

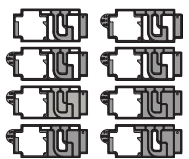
Accessories	Description	Part number	
	Blanking plate kit	PS5534P	
	Sandwich flow control	PS5542P	
	Sandwich Flow Control and Common Port Sandwich Regulator may be sandwiched together on a manifold or subbase. The Sandwich Flow Control MUST be located between the manifold/subbase and the Common Port Sandwich Regulator. Do not use with Independent Port Sandwich Regulators.		
	Pilot pressure control, without sensor, 1/8" BSPP	PS55XXA0P	
	1/4" NPT	PS552600P	
	1/4" BSPP	PS552601P	
	2-60 PSIG w/ gauge	Common pressure	Independent pressure
	5-125 PSIG w/ gauge	PS5537155P	PS5537255P
		PS5537166P	PS5537266P
	#1, 3, 5 ports open	Pilot open	Pilot blocked
	Blocked #1 port	PSHU11P	PSHU15P
	Blocked #1, 3, 5, ports	PSHU12P	PSHU16P
	Blocked #3, 5 ports	PSHU13P	PSHU17P
		PSHU14P	PSHU18P



For inventory, lead times, and kit lookup, visit www.pdnplu.com

D103

Parker Hannifin Corporation
Pneumatic Division
Richland, Michigan
www.parker.com/pneumatics

D

Subbase & Manual Valves

H Series Micro

Modulflex Series

H Series ISO

Network Connectivity

DX ISOMAX Series

Valvair II Series

Common Part Numbers

Valve with Central Connector - 5599-1, Non Plug-in, Size 1 (H1)

Symbol	Type	Cv	Operator	Voltage	Pilot	Non-locking	Locking	
4-Pin Central M12 Connector, 24 VDC								
		4-way, 2-position, spring return	1.5	Single solenoid	24 VDC	Internal	H1EWXBG2B9000FD	H1EWXBH2B9000FD
						External	H1EWXXG2B9000FD	H1EWXXH2B9000FD
		4-way, 2-position, air return	1.5	Single solenoid	24 VDC	Internal	H11WXBG2B9000FD	H11WXBH2B9000FD
						External	H11WXXG2B9000FD	H11WXXH2B9000FD
		4-way, 2-position	1.5	Double solenoid	24 VDC	Internal	H12WXBG2B9000FD	H12WXBH2B9000FD
						External	H12WXXG2B9000FD	H12WXXH2B9000FD
		4-way, 3-position, all ports blocked	1.2	Double solenoid	24 VDC	Internal	H15WXBG2B9000FD	H15WXBH2B9000FD
						External	H15WXXG2B9000FD	H15WXXH2B9000FD
		4-way, 3-position, center exhaust	1.2	Double solenoid	24 VDC	Internal	H16WXBG2B9000FD	H16WXBH2B9000FD
						External	H16WXXG2B9000FD	H16WXXH2B9000FD
		4-way, 3-position, pressure center	1.2	Double solenoid	24 VDC	Internal	H17WXBG2B9000FD	H17WXBH2B9000FD
						External	H17WXXG2B9000FD	H17WXXH2B9000FD

5-Pin Central 7/8" Mini Connector, 120 VAC

		4-way, 2-position, spring return	1.5	Single solenoid	120 VAC	Internal	H1EWXBG323000FD	H1EWXBH323000FD
						External	H1EWXXG323000FD	H1EWXXH323000FD
		4-way, 2-position, air return	1.5	Single solenoid	120 VAC	Internal	H11WXBG323000FD	H11WXBH323000FD
						External	H11WXXG323000FD	H11WXXH323000FD
		4-way, 2-position	1.5	Double solenoid	120 VAC	Internal	H12WXBG323000FD	H12WXBH323000FD
						External	H12WXXG323000FD	H12WXXH323000FD
		4-way, 3-position, all ports blocked	1.2	Double solenoid	120 VAC	Internal	H15WXBG323000FD	H15WXBH323000FD
						External	H15WXXG323000FD	H15WXXH323000FD
		4-way, 3-position, center exhaust	1.2	Double solenoid	120 VAC	Internal	H16WXBG323000FD	H16WXBH323000FD
						External	H16WXXG323000FD	H16WXXH323000FD
		4-way, 3-position, pressure center	1.2	Double solenoid	120 VAC	Internal	H17WXBG323000FD	H17WXBH323000FD
						External	H17WXXG323000FD	H17WXXH323000FD

Valve with 3-Pin DIN Connector - 5599-1, Non Plug-in, Size 1 (H1)

Symbol	Type	Cv	Operator	Voltage	Pilot	Non-locking	Locking	
3-Pin DIN Connector, 24 VDC								
		4-way, 2-position, spring return	1.5	Single solenoid	24 VDC	Internal	H1EWXBBL49D	H1EWXBCL49D
						External	H1EWXXBL49D	H1EWXXCL49D
		4-way, 2-position, air return	1.5	Single solenoid	24 VDC	Internal	H11WXBBL49D	H11WXBCL49D
						External	H11WXXBL49D	H11WXXCL49D
		4-way, 2-position	1.5	Double solenoid	24 VDC	Internal	H12WXBBL49D	H12WXBCL49D
						External	H12WXXBL49D	H12WXXCL49D
		4-way, 3-position, all ports blocked	1.2	Double solenoid	24 VDC	Internal	H15WXBBL49D	H15WXBCL49D
						External	H15WXXBL49D	H15WXXCL49D
		4-way, 3-position, center exhaust	1.2	Double solenoid	24 VDC	Internal	H16WXBBL49D	H16WXBCL49D
						External	H16WXXBL49D	H16WXXCL49D
		4-way, 3-position, pressure center	1.2	Double solenoid	24 VDC	Internal	H17WXBBL49D	H17WXBCL49D
						External	H17WXXBL49D	H17WXXCL49D

Most popular.

D
Subbase & Manual Valves
H Series Micro
Modulflex Series
H Series ISO
Network Connectivity
DX ISOMAX Series
Valvair II Series











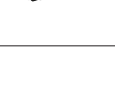
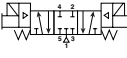

For inventory, lead times, and kit lookup, visit www.pdnplu.com

D104

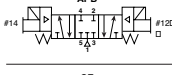

Parker Hannifin Corporation
Pneumatic Division
Richland, Michigan
www.parker.com/pneumatics

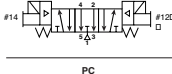
Common Part Numbers

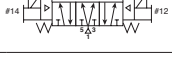

Valve with 3-Pin DIN Connector - 5599-1, Non Plug-in, Size 1 (H1) (continued)

Symbol	Type	Cv	Operator	Voltage	Pilot	Non-locking	Locking	
3-Pin DIN Connector, 120 VAC								
		4-way, 2-position, spring return	1.5	Single solenoid	120 VAC	Internal	H1EWXBBL53D	H1EWXBCL53D
						External	H1EWXXBL53D	H1EWXXCL53D
		4-way, 2-position, air return	1.5	Single solenoid	120 VAC	Internal	H11WXBBL53D	H11WXBCL53D
						External	H11WXXBL53D	H11WXXCL53D
		4-way, 2-position	1.5	Double solenoid	120 VAC	Internal	H12WXBBL53D	H12WXBCL53D
						External	H12WXXBL53D	H12WXXCL53D
		4-way, 3-position, all ports blocked	1.2	Double solenoid	120 VAC	Internal	H15WXBBL53D	H15WXBCL53D
						External	H15WXXBL53D	H15WXXCL53D
		4-way, 3-position, center exhaust	1.2	Double solenoid	120 VAC	Internal	H16WXBBL53D	H16WXBCL53D
						External	H16WXXBL53D	H16WXXCL53D
		4-way, 3-position, pressure center	1.2	Double solenoid	120 VAC	Internal	H17WXBBL53D	H17WXBCL53D
						External	H17WXXBL53D	H17WXXCL53D

Base / End Plate - 5599-1, Non Plug-in, Size 1 (H1)

		Description	NPT	BSPP
	Single subbase	Side ported, 3/8" port	PS4011150DP	PS4011160DP
	Universal manifold base	End ported	PSHU115501P	PSHU115601P
	Universal end plate	Non-collective wiring	PSHU31L000P	PSHU31L001P

Accessories - 5599-1, Non Plug-in, Size 1 (H1)

Accessory	Description	Part number
	Common pressure	5-125 PSIG w/ gauge PS4037166CP
	Independent pressure	5-125 PSIG w/ gauge PS4037266CP
	Blanking plate kit	PS4034CP
	Sandwich flow control	PS4042CP
Sandwich Flow Control and Common Port Sandwich Regulator may be sandwiched together on a manifold or subbase. The Sandwich Flow Control MUST be located between the manifold/subbase and the Common Port Sandwich Regulator. Do not use with Independent Port Sandwich Regulators.		

 Most popular.



For inventory, lead times, and kit lookup, visit www.pdnplu.com

D105

Parker Hannifin Corporation
 Pneumatic Division
 Richland, Michigan
www.parker.com/pneumatics

D

Subbase & Manual Valves

H Series Micro

Modulflex Series

H Series ISO





Network Connectivity

DX ISOMAX Series

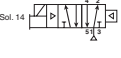

Valvair II Series

Common Part Numbers

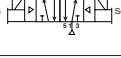
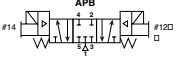
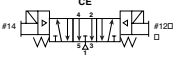
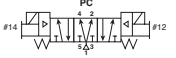

Valve with Central Connector - 5599-1, Non Plug-in, Size 2 (H2)

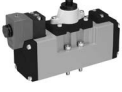
Symbol	Type	Cv	Operator	Voltage	Pilot	Non-locking	Locking	
4-Pin Central M12 Connector, 24 VDC								
		4-way, 2-position, spring return	3.0	Single solenoid	24 VDC	Internal	H2EWXBG2B9000FD	H2EWXBH2B9000FD
						External	H2EWXXG2B9000FD	H2EWXXH2B9000FD
		4-way, 2-position, air return	3.0	Single solenoid	24 VDC	Internal	H21WXBG2B9000FD	H21WXBH2B9000FD
						External	H21WXXG2B9000FD	H21WXXH2B9000FD
		4-way, 2-position	3.0	Double solenoid	24 VDC	Internal	H22WXBG2B9000FD	H22WXBH2B9000FD
						External	H22WXXG2B9000FD	H22WXXH2B9000FD
		4-way, 3-position, all ports blocked	2.8	Double solenoid	24 VDC	Internal	H25WXBG2B9000FD	H25WXBH2B9000FD
						External	H25WXXG2B9000FD	H25WXXH2B9000FD
		4-way, 3-position, center exhaust	2.8	Double solenoid	24 VDC	Internal	H26WXBG2B9000FD	H26WXBH2B9000FD
						External	H26WXXG2B9000FD	H26WXXH2B9000FD
		4-way, 3-position, pressure center	2.8	Double solenoid	24 VDC	Internal	H27WXBG2B9000FD	H27WXBH2B9000FD
						External	H27WXXG2B9000FD	H27WXXH2B9000FD

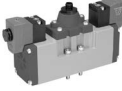
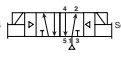
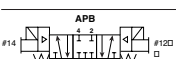
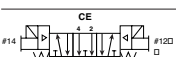
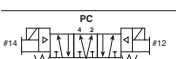
5-Pin Central 7/8" Connector, 120 VAC

		4-way, 2-position, spring return	3.0	Single solenoid	120 VAC	Internal	H2EWXBG323000FD	H2EWXBH323000FD
						External	H2EWXXG323000FD	H2EWXXH323000FD
		4-way, 2-position, air return	3.0	Single solenoid	120 VAC	Internal	H21WXBG323000FD	H21WXBH323000FD
						External	H21WXXG323000FD	H21WXXH323000FD
		4-way, 2-position	3.0	Double solenoid	120 VAC	Internal	H22WXBG323000FD	H22WXBH323000FD
						External	H22WXXG323000FD	H22WXXH323000FD
		4-way, 3-position, all ports blocked	2.8	Double solenoid	120 VAC	Internal	H25WXBG323000FD	H25WXBH323000FD
						External	H25WXXG323000FD	H25WXXH323000FD
		4-way, 3-position, center exhaust	2.8	Double solenoid	120 VAC	Internal	H26WXBG323000FD	H26WXBH323000FD
						External	H26WXXG323000FD	H26WXXH323000FD
		4-way, 3-position, pressure center	2.8	Double solenoid	120 VAC	Internal	H27WXBG323000FD	H27WXBH323000FD
						External	H27WXXG323000FD	H27WXXH323000FD

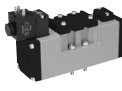
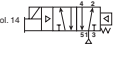
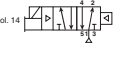
Valve with 3-Pin DIN Connector - 5599-1, Non Plug-in, Size 2 (H2)

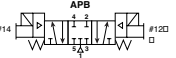
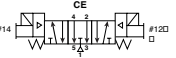
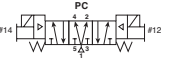
Symbol	Type	Cv	Operator	Voltage	Pilot	Non-locking	Locking	
3-Pin DIN Connector on Coil, 24 VDC								
		4-way, 2-position, spring return	3.0	Single solenoid	24 VDC	Internal	H2EWXBBL49D	H2EWXBCL49D
						External	H2EWXXBL49D	H2EWXXCL49D
		4-way, 2-position, air return	3.0	Single solenoid	24 VDC	Internal	H21WXBBL49D	H21WXBCL49D
						External	H21WXXBL49D	H21WXXCL49D
		4-way, 2-position	3.0	Double solenoid	24 VDC	Internal	H22WXBBL49D	H22WXBCL49D
						External	H22WXXBL49D	H22WXXCL49D
		4-way, 3-position, all ports blocked	2.8	Double solenoid	24 VDC	Internal	H25WXBBL49D	H25WXBCL49D
						External	H25WXXBL49D	H25WXXCL49D
		4-way, 3-position, center exhaust	2.8	Double solenoid	24 VDC	Internal	H26WXBBL49D	H26WXBCL49D
						External	H26WXXBL49D	H26WXXCL49D
		4-way, 3-position, pressure center	2.8	Double solenoid	24 VDC	Internal	H27WXBBL49D	H27WXBCL49D
						External	H27WXXBL49D	H27WXXCL49D

 Most popular.



For inventory, lead times, and kit lookup, visit www.pdnplu.com









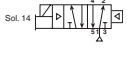

D106

Parker Hannifin Corporation
 Pneumatic Division
 Richland, Michigan
www.parker.com/pneumatics

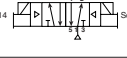

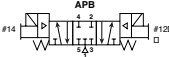
D
 Subbase & Manual Valves
 H Series Micro
 Modulflex Series
 H Series ISO
 Network Connectivity
 DX ISOMAX Series
 Valvair II Series

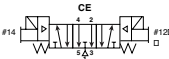
Common Part Numbers

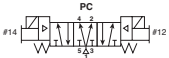

Valve with 3-Pin DIN Connector - 5599-1, Non Plug-in, Size 2 (H2) (continued)

Symbol	Type	Cv	Operator	Voltage	Pilot	Non-locking	Locking	
3-Pin DIN connector on coil, 120 VAC								
		4-way, 2-position, spring return	3.0	Single solenoid	120 VAC	Internal	H2EWXBBL53D	H2EWXBCL53D
						External	H2EWXXBL53D	H2EWXXCL53D
		4-way, 2-position, air return	3.0	Single solenoid	120 VAC	Internal	H21WXBBL53D	H21WXBCL53D
						External	H21WXXBL53D	H21WXXCL53D
		4-way, 2-position	3.0	Double solenoid	120 VAC	Internal	H22WXBBL53D	H22WXBCL53D
						External	H22WXXBL53D	H22WXXCL53D
		4-way, 3-position, all ports blocked	2.8	Double solenoid	120 VAC	Internal	H25WXBBL53D	H25WXBCL53D
						External	H25WXXBL53D	H25WXXCL53D
		4-way, 3-position, center exhaust	2.8	Double solenoid	120 VAC	Internal	H26WXBBL53D	H26WXBCL53D
						External	H26WXXBL53D	H26WXXCL53D
		4-way, 3-position, pressure center	2.8	Double solenoid	120 VAC	Internal	H27WXBBL53D	H27WXBCL53D
						External	H27WXXBL53D	H27WXXCL53D

Base / End Plate - 5599-1, Non Plug-in, Size 2 (H2)

		Description	1/2" NPT	1/2" BSPP
	Single subbase	Side ported, 1/2" port	PS4111170CP	PS4111180CP
	Universal manifold base	End ported	PSHU115701P	PSHU115801P
	Universal end plate	Non-collective wiring	PSHU31L000P	PSHU31L001P

Accessories - 5599-1, Non Plug-in, Size 2 (H2)

Accessory	Description	Part number
	Common pressure	5-125 PSIG w/ gauge PS4137166CP
	Independent pressure	5-125 PSIG w/ gauge PS4137266CP
	Blanking plate kit	PS4134CP
	Sandwich flow control	PS4142CP
	Sandwich Flow Control and Common Port Sandwich Regulator may be sandwiched together on a manifold or subbase. The Sandwich Flow Control MUST be located between the manifold/subbase and the Common Port Sandwich Regulator. Do not use with Independent Port Sandwich Regulators.	

 Most popular.



For inventory, lead times, and kit lookup, visit www.pdnplu.com

D107

Parker Hannifin Corporation
Pneumatic Division
Richland, Michigan
www.parker.com/pneumatics

D

Subbase & Manual Valves

H Series Micro

Modulflex Series

H Series ISO

Network Connectivity

DX ISOMAX Series

Valvair II Series

Ordering Information

End Plate Kit - Universal Non Plug-in



Left hand end plate

PSHU31 L0 0 0 P

Valve Type	
Non Plug-in (internal pilot)	PSHU31
Non Plug-in (external pilot)	PSHU3X

Left Hand End Plate Type	
Non Plug-in	L0

Thread Type	
0	NPT
1*	BSPP "G"

* BSPP Conforms to ISO 1179-1 w 228-1 Threads

Right Hand End Plate Type / Port	
0	Low profile (no ports)
1	1/2 Exhaust and inlet port
2	3/4 Exhaust and inlet port
5*	H3 Transition plate, 1" exhaust and inlet

* 1, 3 & 5 manifold galley blocked at transition plate. 12 & 14 pass through.

Right Hand End Plate



Low Profile

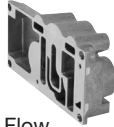

High Flow

Description	NPT port	BSPP port
Right hand end plate only, low profile	PSHU4000P	
Right hand end plate only, high flow 1/2" ports	PSHU4100P	PSHU4101P
Right hand end plate only, high flow 3/4" ports	PSHU4200P	PSHU4201P

H3 Transition Kit



H3 transition, H3 right hand end plate, 1" ports (includes gaskets & bolts)

PSU7300P PSHU7301P

Valve - Non Plug-in, 15407-1, Size 18mm (HB) & 26mm (HA)

HB E WX B G 2 G9 000F A 8P

Basic series 15407-1	
ISO 15407-1 18mm	HB
ISO 15407-1 26mm	HA

15407-1 Operator / Function	
Single solenoid, 2-position - air return	1
Double solenoid, 2-position	2
Double solenoid, 3-position - APB	5
Double solenoid, 3-position - CE	6
Double solenoid, 3-position - PC	7
Single solenoid, 2-position - air return, spring assist	E
Double solenoid, dual 3/2, NC/NC	N†
Double solenoid, dual 3/2, NO/NO	P†
Double solenoid, dual 3/2, 14 end NC - 12 end NO	Q†

† Available on HB Only, must use Internal Pilot Source Option "B".

15407-1 Mounting	
Valve less base	WX

15407-1 Pilot source / Pilot exhaust	
B	Internal pilot, port #1 / vented
L*	External pilot, port #14 / vented

* Must be specified when using Sandwich Regulators.

15407-1 Enclosure / Lead length	
2	4-pin, M12 micro, straight connector

15407-1 Overrides / Lights	
G	Non-locking, flush, push - w/ light
H	Locking, flush, push / turn - w/ light

Options	
Blank	No Options
8P	M8, PNP, Spool Sensing
8N	M8, NPN, Spool Sensing
2P	M12, PNP, Spool Sensing

* Available on HA series with operator functions 1, 2, E only

15407-1 Engineering level	
A	Current

15407-1 Central connector wiring options	
000F	SAE / Ford, ISO 20401

15407-1 Voltage & frequency	
G9	24VDC LED & suppression

Part Number	Cable Type
RKC 4.4T-2	M12, 4 Pin Female, PVC, 2m
PKG 3M-4/S90	M8, 3 Pin Female, PUR, 4M, flying lead

Most popular.



For inventory, lead times, and kit lookup, visit www.pdnplu.com

D108

Parker Hannifin Corporation
Pneumatic Division
Richland, Michigan
www.parker.com/pneumatics

Valve - Non Plug-in, 5599-1, Central Connector - Size 1 & 2

H1 E WX B G 2B9 000F D

Basic Series 5599-1	
ISO 5599-1 Size 1	H1
ISO 5599-1 Size 2	H2

5599 -1 Engineering Level	
D	Current

5599-1 Operator / Function	
Single solenoid, 2-position - air return	1
Double solenoid, 2-position	2
Double solenoid, 3-position - APB	5
Double solenoid, 3-position - CE	6
Double solenoid, 3-position - PC	7
Single solenoid, 2-position - air return, spring assist	E

5599-1 Central Connector Wiring Options	
000C	Chrysler
000F*	SAE / Ford, ISO 20401
000G	General Motors

* Complies to ISO 20401 with Enclosure Lead Length "2".

5599-1 Mounting	
Valve less base	WX

5599-1 Pilot Source / Pilot Exhaust	
Internal pilot, port #1 / vented	B
External pilot, port #12 or #14 / vented	X*

* Must be specified when using Sandwich Regulators.

5599-1 Overrides / Lights	
Non-locking, flush, with light	G
Locking, flush, with light	H

Enclosure / Lead Length / Voltage*				
	AC		DC	
	60Hz	50Hz		
1B9 [†]			24	3-pin, central mini connector, 3.2 watt
1F9 [†]			24	3-pin, central mini connector, 1.3 watt
123 [†]	120	115		3-pin, central mini connector
2B9			24	4-pin, central M12 micro connector, 3.2 watt
2F9*			24	4-pin, central M12 micro connector, 1.3 watt
3B9			24	5-pin, central mini connector, 3.2 watt
3F9*			24	5-pin, central mini connector, 1.3 watt
323	120	115		5-pin, central mini connector
619*			24	2-pin, M12 micro connector on coil

* All coils include LED & suppression

[†] Operator function "1" or "E"

* Only available with wiring option "000F"

* Override "G" only.

Valve - Non Plug-in, 5599-1, CNOMO - Size 1 & 2

H1 E WX B B L53 D

Basic Series 5599-1	
ISO 5599-1 Size 1	H1
ISO 5599-1 Size 2	H2

5599-1 Engineering Level	
D	Current

5599-1 Operator / Function	
Single solenoid, 2-position - air return	1
Double solenoid, 2-position	2
Double solenoid, 3-position - APB	5
Double solenoid, 3-position - CE	6
Double solenoid, 3-position - PC	7
Single solenoid, 2-position - air return, spring assist	E

Enclosure / Lead length / Voltage				
	AC		DC	
	60Hz	50Hz		
L42	24			3-pin, 30mm DIN 43650A with CNOMO connector
L45			12	3-pin, 30mm DIN 43650A with CNOMO connector
L49			24	3-pin, 30mm DIN 43650A with CNOMO connector
L53	120	115		3-pin, 30mm DIN 43650A with CNOMO connector
L57	240			3-pin, 30mm DIN 43650A with CNOMO connector
NXX				Valve less coil

5599-1 Mounting	
Valve less base	WX

5599-1 Pilot Source / Pilot Exhaust	
Internal pilot, port #1 / vented	B
External pilot, port #12 or #14 / vented	X*

* Must be specified when using Sandwich Regulators.

5599-1 Overrides / Lights	
B	Non-locking, flush, push - no light
C	Locking, flush, push / turn - no light

Most popular.



For inventory, lead times, and kit lookup, visit www.pdnplu.com

D109

Parker Hannifin Corporation
Pneumatic Division
Richland, Michigan
www.parker.com/pneumatics

D
 Subbase & Manual Valves
 H Series Micro
 Moduflex Series
 H Series ISO
 Network Connectivity
 DX ISOMAX Series
 Valvair II Series

Remote Pilot - Size 18mm (HB), Size 26mm (HA), Size 1 (H1) & Size 2 (H2)

H1 **4** **WX000XX** **D**

Basic Series	
ISO 15407-1 18mm	HB
ISO 15407-1 26mm	HA*
ISO 5599-1 Size 1	H1*
ISO 5599-1 Size 2	H2*

* Must order remote pilot access plates for manifolds.

Engineering Level	
A	15407 Current
D	5599 Current

Remote Pilot Valve	
WX000XX	Remote pilot valve

15407-1 Operator / Function	
Single remote pilot, 2-position - air return	3
Double remote pilot, 2-position	4
Double remote pilot, 3-position - APB	8
Double remote pilot, 3-position - CE	9
Double remote pilot, 3-position - PC	0
Single remote pilot, 2-position - air return, spring assist	F

Note: For manifolds, end plates, and accessories, see 15407-1 & 5599-1 Non Plug-in valve section.

Note: HB 18mm Valve Remote Pilot Option only available with PL02 Individual Subbase Kits.

D
 Subbase & Manual Valves
 H Series Micro
 Modulflex Series
 H Series ISO
 Network Connectivity
 DX ISOMAX Series
 Valvair II Series

Remote Pilot Access Plate Kit

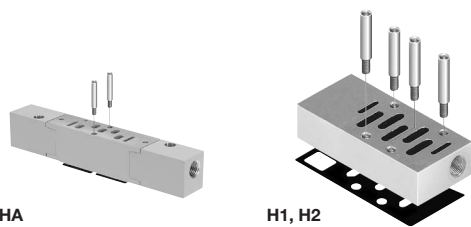

Size	Port size	NPT	BSPP "G"
HA	1/4"	PS551500P	PS551501P
H1	1/8"	PS401500CP	PS401501CP
H2	1/8"	PS411500CP	PS411501CP

Kit includes: Pilot port access plate, gasket and mounting studs.

Most popular.



For inventory, lead times, and kit lookup, visit www.pdnplu.com

D110

Parker Hannifin Corporation
 Pneumatic Division
 Richland, Michigan
www.parker.com/pneumatics

Manifold Kit - Universal Non Plug-in

PSHU1153 **0** **1** **P**

Mounting Style / Port Size	
HB manifold with 1/8 NPT end ports	PSHU1151
HB manifold with 1/8 BSPP end ports	PSHU1152*
HA manifold with 1/4 NPT end ports	PSHU1153
HA manifold with 1/4 BSPP end ports	PSHU1154*
H1 manifold with 3/8 NPT end ports	PSHU1155
H1 manifold with 3/8 BSPP end ports	PSHU1156*
H2 manifold with 1/2 NPT end ports	PSHU1157
H2 manifold with 1/2 BSPP end ports	PSHU1158*

* BSPP conforms to ISO 1179-1 w 228-1 threads.

Gasket Options	
1	1,3,5 ports open and pilots open
2	1,3,5 ports closed and pilots open
3	1 closed, 3,5 ports open and pilots closed
4	1 port open, 3,5 ports closed and pilots open
5	1,3,5 ports open and pilots closed
6	1,3,5 ports closed and pilots closed
7	1 closed, 3,5 ports open and pilots closed
8	1 port open, 3,5 ports closed and pilots open

Circuit Board Address Configuration	
0	No interconnect



HA manifold

Intermediate Air Supply - Universal Non Plug-in

PSHU115A **0** **1** **P**

Mounting Style / Port Size	
Intermediate air supply, NPT / internal pilot	PSHU115A
Intermediate air supply, BSPP / internal pilot	PSHU115B*
Intermediate air supply, NPT / external pilot	PSHU115C
Intermediate air supply, BSPP / external pilot	PSHU115D*

* BSPP Conforms to ISO 1179-1 w 228-1 Threads.

Gasket Options	
1	1,3,5 ports open and pilots open
2	1,3,5 ports closed and pilots open
3	1 closed, 3,5 ports open and pilots closed
4	1 port open, 3,5 ports closed and pilots open
5	1,3,5 ports open and pilots closed
6	1,3,5 ports closed and pilots closed
7	1 closed, 3,5 ports open and pilots closed
8	1 port open, 3,5 ports closed and pilots open

Circuit Board Address Configuration	
0	No electrical



Intermediate air supply

 Most popular.



For inventory, lead times, and kit lookup, visit www.pdnplu.com

D111

Parker Hannifin Corporation
 Pneumatic Division
 Richland, Michigan
www.parker.com/pneumatics

D

Subbase & Manual Valves

H Series Micro

Moduflex Series

H Series ISO

Network Connectivity

DX ISOMAX Series

Valvair II Series

Ordering Information

Pneumatic Zoning

Multiple pressure zones can be created by selecting alternative gaskets between individual manifold segments or an intermediate air supply module. These zones can be designed to meet different application and safety requirements on the machine. Inserting the PXM Pilot Exhaust Module into a one of these zones allows control of pilot pressure for the entire zone.

Gasket Kit - Universal Manifold to Manifold

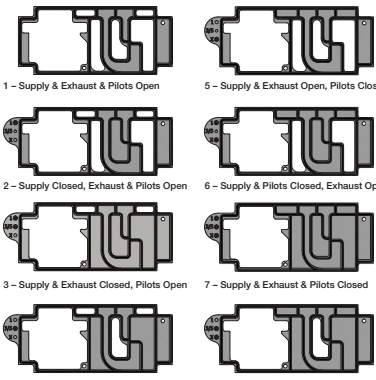
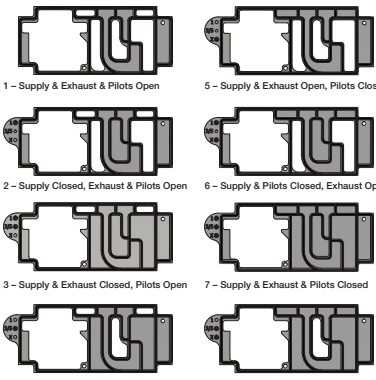
Description		Part number	
 <p>1 – Supply & Exhaust & Pilots Open 2 – Supply Closed, Exhaust & Pilots Open 3 – Supply & Exhaust Closed, Pilots Open 4 – Supply & Pilots Open, Exhaust Closed</p>	Pilots opened	<p>1 – Supply & Exhaust & Pilots Open PSHU11P</p> <p>2 – Supply Closed, Exhaust & Pilots Open PSHU12P</p> <p>3 – Supply & Exhaust Closed, Pilots Open PSHU13P</p> <p>4 – Supply & Pilots Open, Exhaust Closed PSHU14P</p>	
	 <p>5 – Supply & Exhaust Open, Pilots Closed 6 – Supply & Pilots Closed, Exhaust Open 7 – Supply & Exhaust & Pilots Closed 8 – Supply Open, Exhaust & Pilots Closed</p>	Pilots blocked	<p>5 – Supply & Exhaust Open, Pilots Closed PSHU15P</p> <p>6 – Supply & Pilots Closed, Exhaust Open PSHU16P</p> <p>7 – Supply & Exhaust & Pilots Closed PSHU17P</p> <p>8 – Supply Open, Exhaust & Pilots Closed PSHU18P</p>

Pilot Exhaust Module

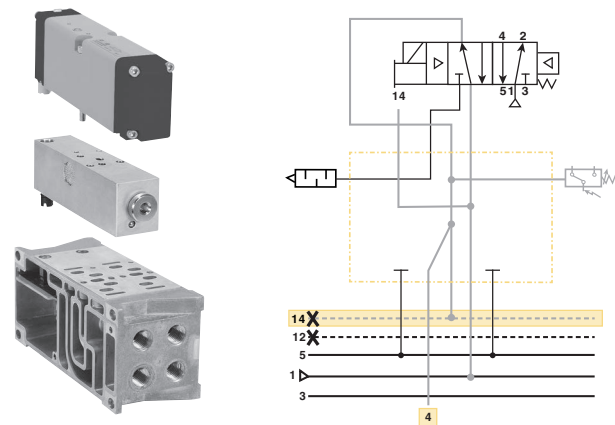

PXM Pilot Exhaust Module enables an H Series HA Single Solenoid valve to control the pilot pressure to other externally piloted H Series ISO valves in the same manifold zone. The HA valve in conjunction with the PXM will remove pilot pressure to all externally piloted valves in the manifold zone when solenoid 14 is de-energized (off). Control of all externally piloted valves in the zone is disabled for both solenoid actuation and manual override until solenoid 14 of the HA valve on the PXM is energized again (on).

Gaskets blocking pilot pressure are required at the start of the zone the PXM is controlling. Special zoning gaskets (shown below) are available to meet any application requirement. In the example below, main pressure and exhaust pass through to the second zone, but pilot pressure is blocked. This results in the PXM providing pilot pressure for the zone after this gasket.

Part Number	Sensor Type
PS55XXA0P	No sensing
PS55XXM0P	Mechanical pressure switch
PS55XXE0P	Solid state pressure switch

Part Number	Cable Type
RKC4.4T-2	M12 cable, PVC, 2m

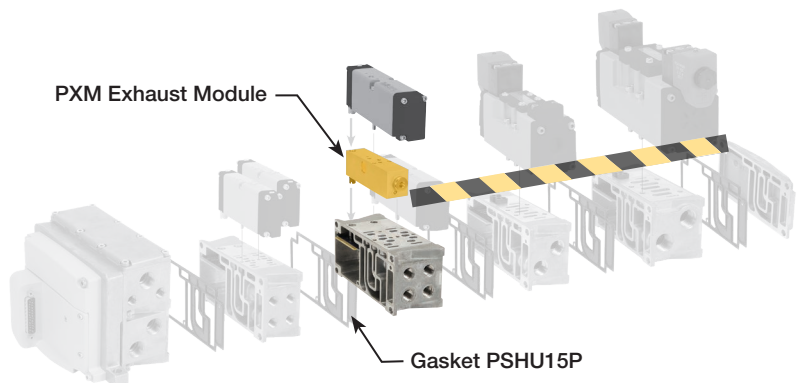

D
 Subbase & Manual Valves
 H Series Micro
 Modulflex Series
 H Series ISO
 Network Connectivity
 DX ISOMAX Series
 Valvair II Series



For inventory, lead times, and kit lookup, visit www.pdnplu.com

Ordering Information

Sandwich Regulator - Non Plug-in, 15407-1

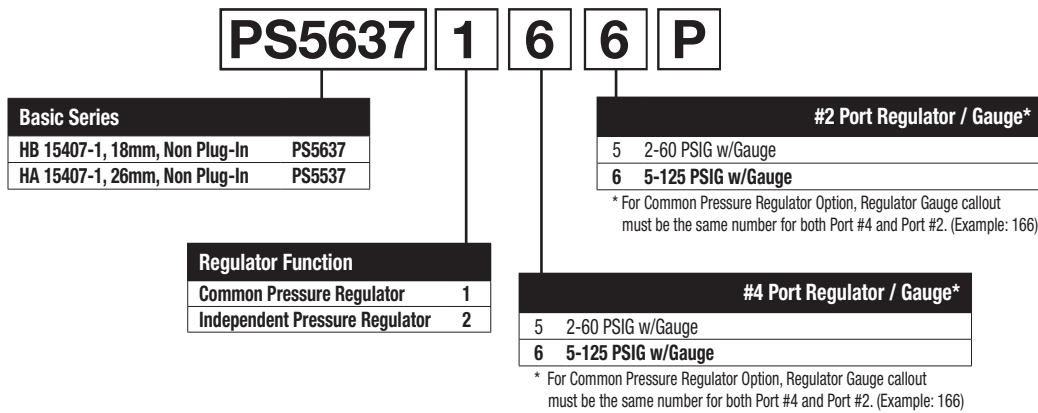

HB - 18mm
(Independent Dual Port Regulator shown)



HA - 26mm
(Common Port Regulator shown)

Ordering Components

- Manifold or Subbase Kit required.
- Sandwich Regulator Kit configured for Internal Pilot as standard.
- Order valve as External Pilot.

How to Configure Sandwich Regulator / Valve Combinations

Internal Pilot Configuration of Sandwich Regulator HA, HB

Pressure in Base Port 1 feeds regulator configured for Internal Pilot which feeds valve configured for External Pilot.

Accessories	Description	Part number
 Gauge adapter kit	Includes 1/8" coupling, long nipple, and gauge	PS5651160P

Sandwich Regulator Cv Flow Chart*

	Common Pressure Code 166				Dual Pressure Code 266			
	1-2	1-4	2-3	4-5	1-2	1-4	2-3	4-5*
HB	0.20	0.20	0.41	0.34	0.23	0.19	0.28	0.27
HA	0.41	0.43	0.87	0.89	0.42	0.45	0.68	0.66

* Regulator Port exhaust through Base Port 3.
Note: All Cv's calculated with regulator adjusted full open.



For inventory, lead times, and kit lookup, visit www.pdnplu.com

D113

Parker Hannifin Corporation
Pneumatic Division
Richland, Michigan
www.parker.com/pneumatics

D

Subbase & Manual Valves

H Series Micro

Modulflex Series

H Series ISO

Network Connectivity

DX ISOMAX Series

Valvair II Series

Sandwich Regulator - Non Plug-in, 5599-1

PS4037 1 6 6 C P

Basic Series	
H1 5599-1, Non Plug-in	PS4037
H2 5599-1, Non Plug-in	PS4137

Regulator Function	
Common Pressure Regulator	1
Independent Pressure Regulator	2

#2 Port Regulator / Gauge*	
0**	Line By-Pass Plate
4	1-30 PSIG w/Gauge
5	2-60 PSIG w/Gauge
6	5-125 PSIG w/Gauge
D	Remote Pilot ISO 2 & 3 only

* For common pressure regulator option, regulator gauge callout must be the same number for both Port #4 and Port #2. (Example: 166)

** Pressure Line by-pass option can only be used with independent pressure regulators.

#4 Port Regulator / Gauge*	
0**	Line By-Pass Plate
4	1-30 PSIG w/Gauge
5	2-60 PSIG w/Gauge
6	5-125 PSIG w/Gauge
D	Remote Pilot ISO 2 & 3 only

* For common pressure regulator option, regulator gauge callout must be the same number for both Port #4 and Port #2. (Example: 166)

** Pressure Line by-pass option can only be used with independent pressure regulators.

Ordering Components

- Sandwich regulator kit configured for internal pilot as standard.
- Order valve as external pilot.



H1 - Size 1
(Independent Dual Port Regulator shown)

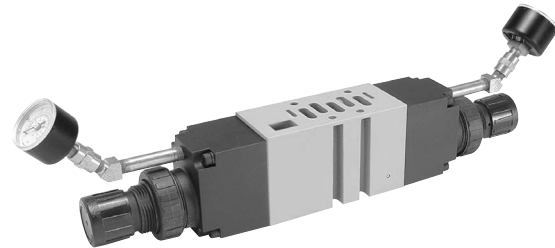

H2 - Size 2
(Independent Dual Port Regulator shown)

How to Configure Sandwich Regulator / Valve Combinations

Internal Pilot Configuration of Sandwich Regulator H1 & H2

Pressure in Base Port 1 feeds regulator configured for Internal Pilot which feeds valve configured for External Pilot.

External Pilot Configuration of Sandwich Regulator H1 & H2

An External Pilot pressure in Port 12 or 14 of the base feeds thru the Sandwich Regulator 12 or 14 galley directly to the 12/14 pilot of the valve. This configuration takes an External Pilot from the 12 port of the base and passes it thru the regulator to feed the 12 galley of the valve.

Sandwich Regulator Cv Flow Chart*

	Common Pressure Code 166				Single Pressure 2 Code 206				Single Pressure 4 Code 260				Dual Pressure Code 266			
	1-2	1-4	2-3	4-5	1-2	1-4	2-3	4-5*	1-2	1-4	2-3	4-5*	1-2	1-4	2-3	4-5*
H1	0.62	0.61	1.28	1.18	0.73	0.96	0.96	0.93	0.34	0.70	0.94	0.98	0.52	0.48	0.86	0.88
H2	1.47	1.60	2.41	2.33	1.71	1.90	1.52	1.75	1.74	1.67	1.73	1.79	1.61	1.62	1.50	1.67

* Regulator Port exhaust through Base Port 3.

Note: All Cv's calculated with regulator adjusted full open.

Most popular.



For inventory, lead times, and kit lookup, visit www.pdnplu.com

D114

Parker Hannifin Corporation
Pneumatic Division
Richland, Michigan
www.parker.com/pneumatics

D
 Subbase & Manual Valves
 H Series Micro
 Modulflex Series
 H Series ISO
 Network Connectivity
 DX ISOMAX Series
 Valvair II Series

Online Configuration

Navigate to the landing page

www.parker.com/pdn/HSeriesISO

Customize your manifold assembly

Create and save a unique assembled part number

Generate a CAD model

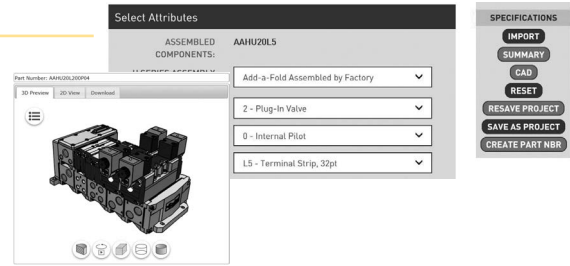

Add-A-Fold - Universal Non Plug-in

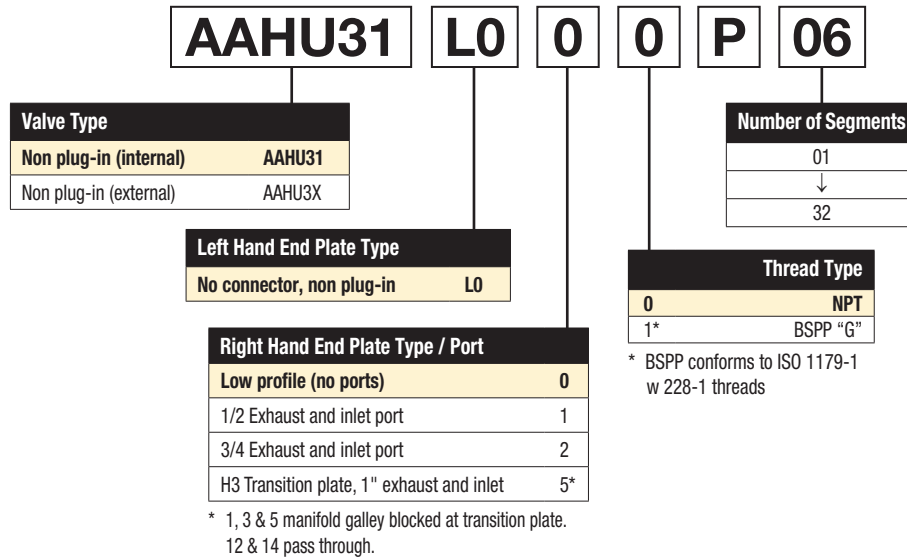

How To Order Plug-in Add-A-Fold Assemblies

1. List Add-A-Fold Assembly call out. This automatically includes the end plate kit assembly.
2. List complete valve, regulator, flow control and manifold base kit. List left to right, LOOKING AT THE CYLINDER PORTS on the #12 end of the manifold. The left most segment is segment 1. (If a blank station is needed, list the blanking plate part number and the individual manifold part numbers for the required segment.)

Example

Application requires a 4 segment manifold.

Item	Part No.	Location	
01	AAHU31L000P04		
02	HB2WXBG2G9000FA	Segment 1	Valve station 1
03	HB2WXBG2G9000FA		Valve station 2
04	PSHU115101P		Manifold base
05	HA1WXBG2G9000FA	Segment 2	Valve station 3
06	HA2WXBG2G9000FA		Valve station 4
07	PSHU115301P	Manifold base	
08	H12WXBG2B9000FD	Segment 3	Valve station 5
09	PSHU115501P		Manifold base
10	H22WXBG2B9000FD	Segment 4	Valve station 6
11	PSHU115701P		Manifold base

Most popular.

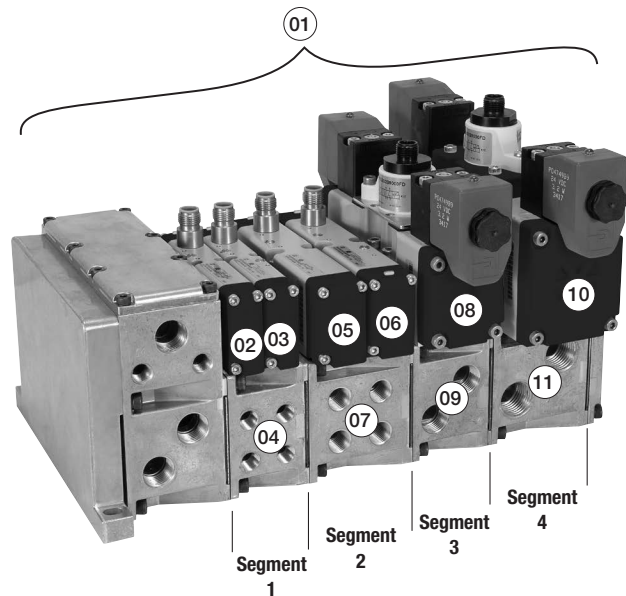

Example:
 4 segment manifold with (2) HB, (2) HA, (1) H1, and (1) H2 valve on manifold bases with low profile, NPT end plate.



For inventory, lead times, and kit lookup, visit www.pdnplu.com

D115

Parker Hannifin Corporation
 Pneumatic Division
 Richland, Michigan
www.parker.com/pneumatics

D

Subbase & Manual Valves

H Series Micro

Moduflex Series

H Series ISO

Network Connectivity

DX ISOMAX Series

Valvair II Series

Ordering Information

Subbase Kit - Non Plug-in



HA non plug-in subbase shown

PS55 1113 0 P

Series	
HA Subbase	PS55
H1 Subbase	PS40
H2 Subbase	PS41

Engineering Level	
Blank	HA Series
D	H1 Series
C	H2 Series

Mounting Style / Port Size	
HA Series	
1/4 NPT side ports	1113
1/4 BSPP side ports	1114*
1/4 NPT bottom / side ports	1123
1/4 BSPP bottom / side ports	1124*
H1 Series	
3/8 NPT side ports	1115
3/8 BSPP side ports	1116*
H2 Series	
1/2 NPT side ports	1117
1/2 BSPP side ports	1118*

Enclosures / Lead Length	
0	None, No Electrical Plug

* BSPP conforms to ISO 1179-1 w 228-1 threads.

HB Series ISO 15407-1 Size 18mm (HB) Single Subbase

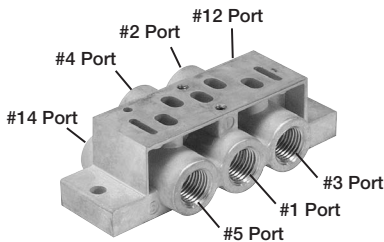

Side ported base
18mm DX02 / HB

1/8" NPT	1/8" BSPP
PL02-01-80	PL02-01-70

Note: Can be used for external, single, or double remote pilot.

D
 Subbase & Manual Valves
 H Series Micro
 Modulflex Series
 H Series ISO
 Network Connectivity
 DX ISOMAX Series
 Valvair II Series



For inventory, lead times, and kit lookup, visit www.pdnplu.com

D116

Parker Hannifin Corporation
Pneumatic Division
Richland, Michigan
www.parker.com/pneumatics

Common Part Numbers

Valve with Central Connectors - 5599-1, Non Plug-in, Size 3 (H3)

Symbol	Type	Cv	Operator	Voltage	Pilot	Non-locking	Locking	
	Sol. 14	4-way, 2-position, spring return	6.0	Single solenoid	24 VDC	Internal	H3EWXBG2B9000FD	H3EWXBH2B9000FD
						External	H3EWWXG2B9000FD	H3EWWXH2B9000FD
	Sol. 14	4-way, 2-position, air return	6.0	Single solenoid	24 VDC	Internal	H31WXBG2B9000FD	H31WXBH2B9000FD
						External	H31WXXG2B9000FD	H31WXXH2B9000FD
	Sol. 14	4-way, 2-position	6.0	Double solenoid	24 VDC	Internal	H32WXBG2B9000FD	H32WXBH2B9000FD
						External	H32WXXG2B9000FD	H32WXXH2B9000FD
	APB #14	4-way, 3-position, all ports blocked	5.0	Double solenoid	24 VDC	Internal	H35WXBG2B9000FD	H35WXBH2B9000FD
						External	H35WXXG2B9000FD	H35WXXH2B9000FD
	CE #14	4-way, 3-position, center exhaust	5.0	Double solenoid	24 VDC	Internal	H36WXBG2B9000FD	H36WXBH2B9000FD
						External	H36WXXG2B9000FD	H36WXXH2B9000FD
	PC #14	4-way, 3-position, pressure center	5.0	Double solenoid	24 VDC	Internal	H37WXBG2B9000FD	H37WXBH2B9000FD
						External	H37WXXG2B9000FD	H37WXXH2B9000FD

5-Pin, Central 7/8" Mini Connector, 120 VAC

	Sol. 14	4-way, 2-position, spring return	6.0	Single solenoid	120 VAC	Internal	H3EWXBG323000FD	H3EWXBH323000FD
						External	H3EWWXG323000FD	H3EWWXH323000FD
	Sol. 14	4-way, 2-position, air return	6.0	Single solenoid	120 VAC	Internal	H31WXBG323000FD	H31WXBH323000FD
						External	H31WXXG323000FD	H31WXXH323000FD
	Sol. 14	4-way, 2-position	6.0	Double solenoid	120 VAC	Internal	H32WXBG323000FD	H32WXBH323000FD
						External	H32WXXG323000FD	H32WXXH323000FD
APB #14	4-way, 3-position, all ports blocked	5.0	Double solenoid	120 VAC	Internal	H35WXBG323000FD	H35WXBH323000FD	
					External	H35WXXG323000FD	H35WXXH323000FD	
CE #14	4-way, 3-position, center exhaust	5.0	Double solenoid	120 VAC	Internal	H36WXBG323000FD	H36WXBH323000FD	
					External	H36WXXG323000FD	H36WXXH323000FD	
PC #14	4-way, 3-position, pressure center	5.0	Double solenoid	120 VAC	Internal	H37WXBG323000FD	H37WXBH323000FD	
					External	H37WXXG323000FD	H37WXXH323000FD	

Valve with 3-Pin DIN Connectors - 5599-1, Non Plug-in, Size 3 (H3)

Symbol	Type	Cv	Operator	Voltage	Pilot	Non-locking	Locking	
	Sol. 14	4-way, 2-position, spring return	6.0	Single solenoid	24 VDC	Internal	H3EWWBBL49D	H3EWWBCL49D
						External	H3EWWXBL49D	H3EWWXCL49D
	Sol. 14	4-way, 2-position, air return	6.0	Single solenoid	24 VDC	Internal	H31WXBBL49D	H31WXBCL49D
						External	H31WXXBL49D	H31WXXCL49D
	Sol. 14	4-way, 2-position	6.0	Double solenoid	24 VDC	Internal	H32WXBBL49D	H32WXBCL49D
						External	H32WXXBL49D	H32WXXCL49D
APB #14	4-way, 3-position, all ports blocked	5.0	Double solenoid	24 VDC	Internal	H35WXBBL49D	H35WXBCL49D	
					External	H35WXXBL49D	H35WXXCL49D	
CE #14	4-way, 3-position, center exhaust	5.0	Double solenoid	24 VDC	Internal	H36WXBBL49D	H36WXBCL49D	
					External	H36WXXBL49D	H36WXXCL49D	
PC #14	4-way, 3-position, pressure center	5.0	Double solenoid	24 VDC	Internal	H37WXBBL49D	H37WXBCL49D	
					External	H37WXXBL49D	H37WXXCL49D	

Most popular.



For inventory, lead times, and kit lookup, visit www.pdnplu.com

D117

Parker Hannifin Corporation
Pneumatic Division
Richland, Michigan
www.parker.com/pneumatics

D

Subbase & Manual Valves

H Series Micro

Modulflex Series

H Series ISO









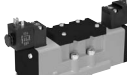
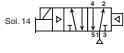

Network Connectivity

DX ISOMAX Series

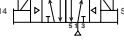

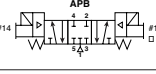
Valvair II Series

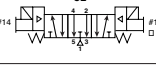
Common Part Numbers

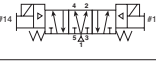





Valve with 3-Pin DIN Connectors - 5599-1, Non Plug-in, Size 3 (H3)

Symbol	Type	Cv	Operator	Voltage	Pilot	Non-locking	Locking
3-Pin DIN Connector on Coil, 120 VDC							
		6.0	Single solenoid	120 VAC	Internal	H3EWXBBL53D	H3EWXBCL53D
						External	H3EWXXBL53D
		6.0	Single solenoid	120 VAC	Internal	H31WXBBL53D	H31WXBCL53D
						External	H31WXXBL53D
		6.0	Double solenoid	120 VAC	Internal	H32WXBBL53D	H32WXBCL53D
						External	H32WXXBL53D
		5.0	Double solenoid	120 VAC	Internal	H35WXBBL53D	H35WXBCL53D
						External	H35WXXBL53D
		5.0	Double solenoid	120 VAC	Internal	H36WXBBL53D	H36WXBCL53D
						External	H36WXXBL53D
		5.0	Double solenoid	120 VAC	Internal	H37WXBBL53D	H37WXBCL53D
						External	H37WXXBL53D

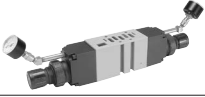
Base / End Plate - 5599-1, Non Plug-in, Size 3 (H3) * Not compatible with H Universal

Description	NPT	BSP
 Single subbase Side ported base, 3/4" port	PS4211190CP	PS4211180CP
 Manifold base End ported bases Bottom / end ported bases	PS4211590CP	PS4211500CP
	PS4211690CP	PS4211600CP
Note: Manifolds include 2 pipe plugs		
 End plate End plate - non-collective wiring	PS4231010DP	PS4231011DP

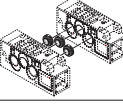
Accessories - 5599-1, Non Plug-in, Size 3 (H3)

Accessory	Description	Part number
 Sandwich regulator	Common pressure 5-125 PSIG w/ gauge	PS4237166CP
	Independent pressure 5-125 PSIG w/ gauge	PS4237266CP
 Blanking plate kit		PS4234CP
 Sandwich flow control		PS4242CP
	Sandwich Flow Control and Common Port Sandwich Regulator may be sandwiched together on a manifold or subbase. The Sandwich Flow Control MUST be located between the manifold/subbase and the Common Port Sandwich Regulator. Do not use with Independent Port Sandwich Regulators.	
 Manifold to manifold gasket kits		PS4213P
 Manifold port isolation kit	Main galley (1, 3, 5)	PS4232CP
 Manifold port isolation kit	Pilot galley (12, 14)	PS4033CP

 Most popular.

D
Subbase & Manual Valves
H Series Micro
Modulflex Series
H Series ISO
Network Connectivity
DX ISOMAX Series
Valvair II Series



For inventory, lead times, and kit lookup, visit www.pdnplu.com

D118

Parker Hannifin Corporation
 Pneumatic Division
 Richland, Michigan
www.parker.com/pneumatics

Valve Central Connector - Non Plug-in, 5599-1, Size 3 (H3)

H3 E WX B G 2B9 000F D

Basic Series 5599-1

ISO 5599-1 Size 3 H3

5599-1 Operator / Function

Single solenoid, 2-position - air return	1
Double solenoid, 2-position	2
Double solenoid, 3-position - APB	5
Double solenoid, 3-position - CE	6
Double solenoid, 3-position - PC	7
Single solenoid, 2-position - air return, spring assist	E

5599-1 Mounting

Valve less base WX

5599-1 Pilot Source / Pilot Exhaust

Internal pilot, port #1 / vented B

External pilot, port #12 or #14 / vented X*

* Must be specified when using Sandwich Regulators.

5599-1 Overrides / Lights

Non-locking, flush, with light G

Locking, flush, with light H

5599-1 Engineering Level

D Current

5599-1 Central Connector Wiring Options

000C	Chrysler
000F*	SAE / Ford, ISO 20401
000G	General Motors

* Complies to ISO 20401 with Enclosure Lead Length "2".

Enclosure / Lead length / Voltage*

	AC		DC	
	60Hz	50Hz		
1B9†			24	3-pin, central mini connector, 3.2 watt
1F9†			24	3-pin, central mini connector, 1.3 watt
123†	120	115		3-pin, central mini connector
2B9			24	4-pin, central M12 connector, 3.2 watt
2F9*			24	4-pin, central M12 connector, 1.3 watt
3B9			24	5-pin, central mini connector, 3.2 watt
3F9*			24	5-pin, central mini connector, 1.3 watt
323	120	115		5-pin, central mini connector
619*			24	2-pin, M12 connector on coil

* All coils include LED & suppression
† Operator function "1" or "E"
‡ Only available with wiring option "000F"
* Override "G" only.

Valve CNOMO - Non Plug-in, 5599-1 Size 3 (H3)

H3 E WX B B L53 D

Basic Series 5599-1

ISO 5599-1 Size 3 H3

5599-1 Operator / Function

Single solenoid, 2-position - air return	1
Double solenoid, 2-position	2
Double solenoid, 3-position - APB	5
Double solenoid, 3-position - CE	6
Double solenoid, 3-position - PC	7
Single solenoid, 2-position - air return, spring assist	E

5599-1 Mounting

Valve less base WX

5599-1 Pilot Source / Pilot Exhaust

Internal pilot, port #1 / vented B

External pilot, port #12 or #14 / vented X*

* Must be specified when using Sandwich Regulators.

5599-1 Overrides / Lights

B	Non-locking, flush, push - no light
C	Locking, flush, push / turn - no light

5599-1 Engineering Level

D Current

Enclosure / Lead Length / Voltage

	AC		DC	
	60Hz	50Hz		
L42	24			3-pin, 30mm DIN 43650A with CNOMO connector
L45			12	3-pin, 30mm DIN 43650A with CNOMO connector
L49			24	3-pin, 30mm DIN 43650A with CNOMO connector
L53	120	115		3-pin, 30mm DIN 43650A with CNOMO connector
L57	240			3-pin, 30mm DIN 43650A with CNOMO connector
NXX				Valve less coil

Most popular.



For inventory, lead times, and kit lookup, visit www.pdnplu.com

D119

Parker Hannifin Corporation
Pneumatic Division
Richland, Michigan
www.parker.com/pneumatics

D
 Subbase & Manual Valves
 H Series Micro
 Moduflex Series
 H Series ISO
 Network Connectivity
 DX ISOMAX Series
 Valvair II Series

Remote Pilot - Size 3 (H3)

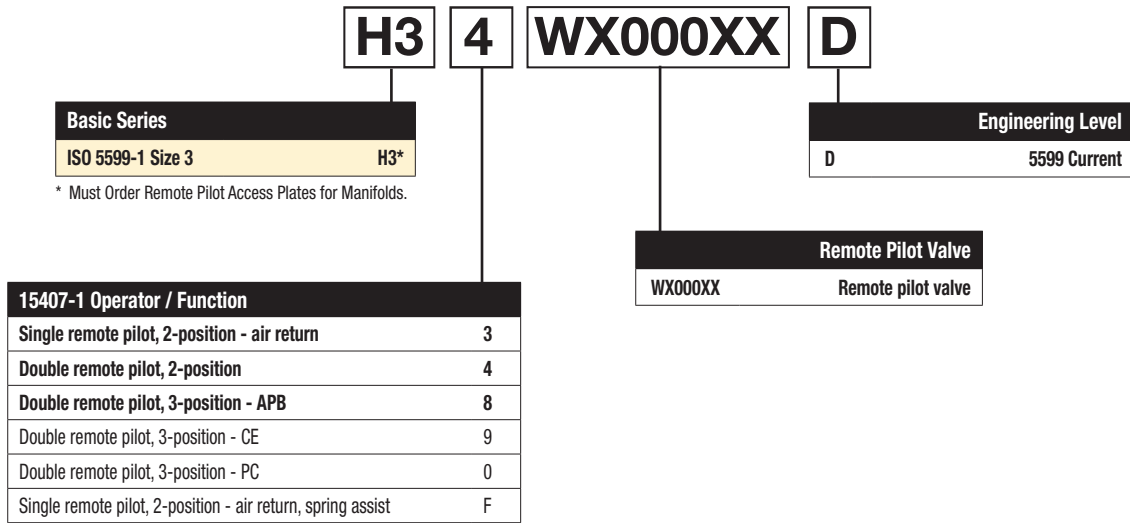

Note: For manifolds, end plates, and accessories, see 5599-1 Non Plug-in valve section.

Remote Pilot Access Plate Kits

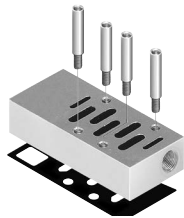

Size	Port size	NPT	BSPG "G"
H3	1/8"	PS421500CP	PS421501CP

Kit includes: Pilot Port Access Plate, Gasket and Mounting Studs.

Most popular.



For inventory, lead times, and kit lookup, visit www.pdnplu.com

D
 Subbase & Manual Valves
 H Series Micro
 Modulflex Series
 H Series ISO
 Network Connectivity
 DX ISOMAX Series
 Valvair II Series

Ordering Information

Manifold / Subbase Kit - Non Plug-in, 5599-1, Size 3 (H3)

PS421159 **0** **C** **P**

Mounting Base Style / Port Size	
Subbase: 3/4 NPT side ports	PS421119
Subbase: 3/4 BSPP side port	PS421110*
Manifold: 3/4 NPT End port	PS421159
Manifold: 3/4 BSPP end port	PS421150*
Manifold: 3/4 NPT bottom / end port	PS421169
Manifold: 3/4 BSPP bottom / end port	PS421160*

Engineering Level	
C	H3

Enclosures / Lead Length	
0	None, No Electrical Plug - 5599-1

* BSPP conforms to ISO 1179-1 w 228-1 threads.

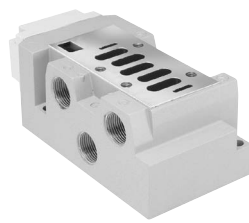

H3 Subbase shown



H3 Manifold shown

End Plate Kit - Non plug-in, 5599-1 * Not compatible with H Universal

PS423101 **0** **D** **P**

Basic Series	
ISO 5599, Size 3	PS423101

Thread Type	
0	NPT
1*	BSPP "G"

* BSPP conforms to ISO 1179-1 w 228-1 threads.

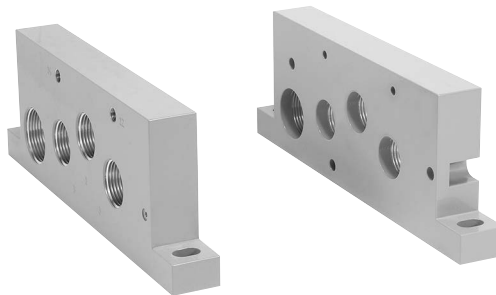

H3 Non-Collective Wiring End Plates shown

 Most popular.



For inventory, lead times, and kit lookup, visit www.pdnplu.com

D121

Parker Hannifin Corporation
 Pneumatic Division
 Richland, Michigan
www.parker.com/pneumatics

D

Subbase & Manual Valves

H Series Micro

Moduflex Series

H Series ISO

Network Connectivity

DX ISOMAX Series

Valvair II Series

Ordering Information

Add-A-Fold Assembly - Non Plug-in, 5599-1, Size 3 (H3) * Not compatible with H Universal

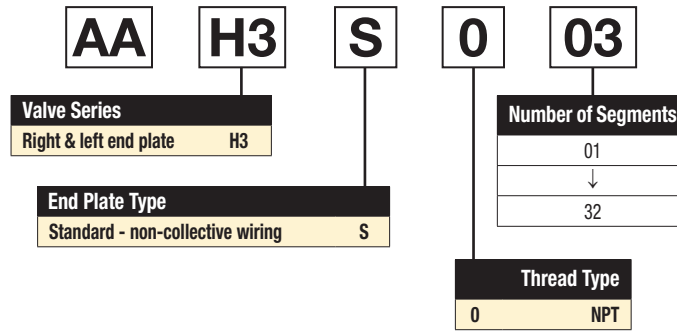

How To Order Non Plug-in Add-A-Fold Assemblies

1. List Add-A-Fold Assembly call out. This automatically includes the end plate kit assembly.
2. List complete valve, regulator, flow control and manifold base kit. List left to right, LOOKING AT THE CYLINDER PORTS on the #12 end of the manifold. The left most segment is segment 1. (If a blanking plate part number and the individual manifold part numbers for the required segment.)

Example

Application requires a 3 segment manifold and regulator on segment 3.

Item	Part No.	Location	
01	AAH3S003		
02	H31WXBG2B9000FD	Segment 1	Valve station 1
03	PS4211590CP		Manifold base
04	H32WXBG2B9000FD	Segment 2	Valve station 2
05	PS4211590CP		Manifold base
06	H32WXXG2B9000FD	Segment 3	Valve station 3
07	PS4237166CP		Sandwich regulator
08	PS4211590CP		Manifold base

NOTE: Construct manifold assemblies from left to right while looking at the cylinder ports.
 Valves must be ordered as External Pilot when using Sandwich Regulator.

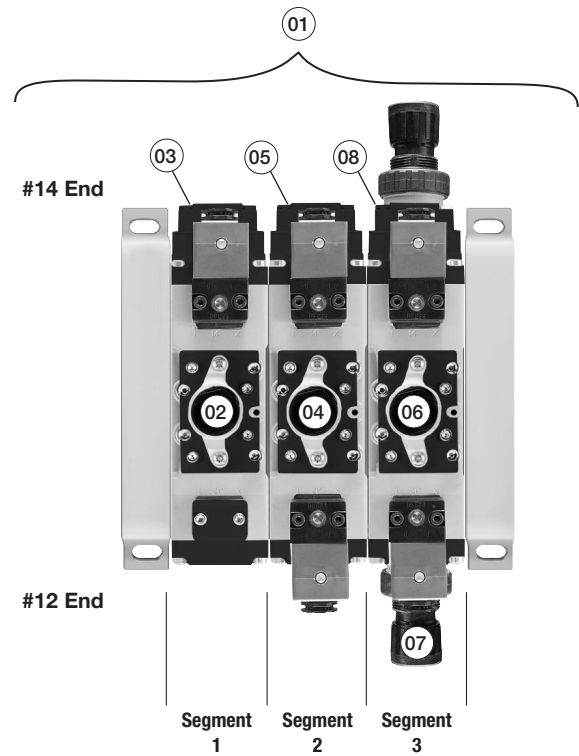

Example:
 3 segment manifold with (3) H3 valves on manifold bases and regulator at segment 3.

D

Subbase & Manual Valves

H Series Micro

Modulflex Series

H Series ISO

Network Connectivity

DX ISOMAX Series

Valvair II Series

Most popular.



For inventory, lead times, and kit lookup, visit www.pdnplu.com

Ordering Information

Sandwich Regulator - Non Plug-in, 5599-1, Size 3 (H3)

PS4237 | **1** | **6** | **6** | **C** | **P**

Basic Series

H3 5599-1, Non Plug-in PS4237

Regulator Function

Common Pressure Regulator	1
Independent Pressure Regulator	2

#2 Port Regulator / Gauge*

0**	Line By-Pass Plate
4	1-30 PSIG w/Gauge
5	2-60 PSIG w/Gauge
6	5-125 PSIG w/Gauge
D	Remote Pilot ISO 2 & 3 only

* For common pressure regulator option, regulator gauge callout must be the same number for both Port #4 and Port #2. (Example: 166)
** Pressure line by-pass option can only be used with independent pressure regulators.

#4 Port Regulator / Gauge*

0**	Line By-Pass Plate
4	1-30 PSIG w/Gauge
5	2-60 PSIG w/Gauge
6	5-125 PSIG w/Gauge
D	Remote Pilot ISO 2 & 3 only

* For common pressure regulator option, regulator gauge callout must be the same number for both Port #4 and Port #2. (Example: 166)
** Pressure line by-pass option can only be used with independent pressure regulators.

Ordering Components

- Sandwich regulator kit configured for internal pilot as standard.
- Order valve as external pilot.

How to Configure Sandwich Regulator / Valve Combinations

Internal Pilot Configuration of Sandwich Regulator H3

Pressure in Base Port 1 feeds regulator configured for Internal Pilot which feeds valve configured for External Pilot.

External Pilot Configuration of Sandwich Regulator H3

An External Pilot pressure in Port 12 or 14 of the base feeds thru the Sandwich Regulator 12 or 14 galley directly to the 12/14 pilot of the valve. This configuration takes an External Pilot from the 12 port of the base and passes it thru the regulator to feed the 12 galley of the valve.

Note: Do not use Independent Port Sandwich Regulators with Sandwich Flow Controls.

Independent Port Sandwich Port Regulators combine the #3 and #5 valve exhaust ports into the #5 exhaust at the manifold/subbase interface. The #3 port flow control will control both #3 and #5 exhaust. #5 port flow control is ineffective.

Sandwich Regulator Cv Flow Chart*

	Common Pressure Code 166				Single Pressure 2 Code 206				Single Pressure 4 Code 260				Dual Pressure Code 266			
	1-2	1-4	2-3	4-5	1-2	1-4	2-3	4-5*	1-2	1-4	2-3	4-5*	1-2	1-4	2-3	4-5*
H3	2.37	2.39	4.30	4.47	2.37	2.81	2.75	3.01	2.65	2.59	2.68	2.74	2.43	2.41	3.16	3.04

* Regulator Port exhaust through Base Port 3.

Note: All Cv's calculated with regulator adjusted full open.

 Most popular.



For inventory, lead times, and kit lookup, visit www.pdnplu.com

D123

Parker Hannifin Corporation
 Pneumatic Division
 Richland, Michigan
www.parker.com/pneumatics

D

Subbase & Manual Valves

H Series Micro

Modulflex Series

H Series ISO

Network Connectivity

DX ISOMAX Series

Valvair II Series

ISO Pneumatic Valve Standard Definitions

15407-1: Non-Plug-in Standards for Size 01 (26mm) & Size 02 (18mm) Wide Valves

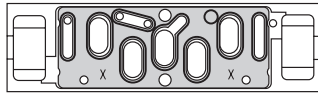

15407-2: Plug-in Standards for Size 01 (26mm) & Size 02 (18mm) Wide Valves

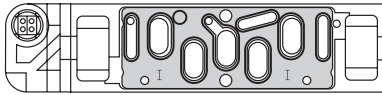

5599-1: Non-Plug-in Standards for Sizes 1, 2, 3

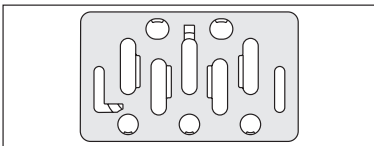

5599-2: Plug-in Standards for Size 1, 2, 3

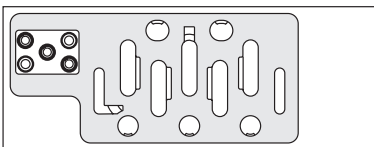

HB / HA Series

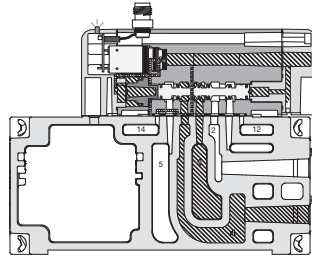

15407-1 18mm Single Solenoid Internal Pilot Manifold Mounted

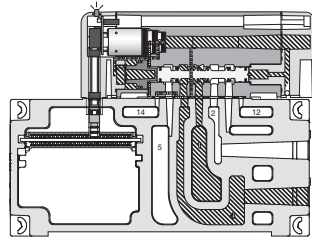

15407-2 18mm Single Solenoid Internal Pilot Manifold Mounted

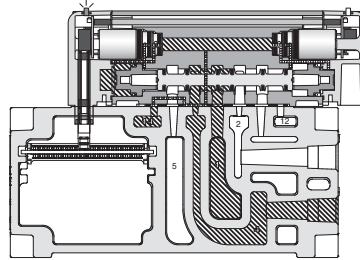

15407-2 26mm Double Solenoid External Pilot Manifold Mounted

▨ Pressure □ Exhaust

H1, H2, H3 Series

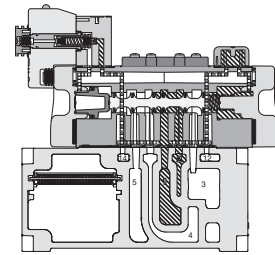

H1 5599-2 Single Solenoid Internal Pilot Manifold Mounted

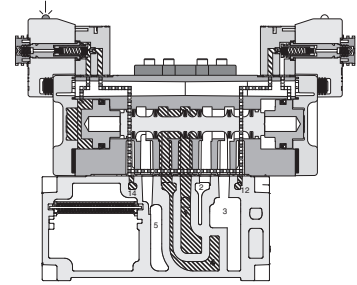

H2 5599-2 Double Solenoid External Pilot Manifold Mounted

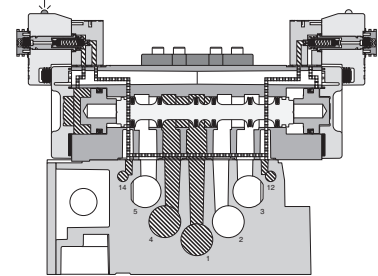

H3 5599-2 Double Solenoid External Pilot Subbase Mounted

▨ Pressure □ Exhaust

D
Subbase & Manual Valves
H Series Micro
Modulflex Series
H Series ISO
Network Connectivity
DX ISOMAX Series
Valvair II Series

Wear Compensation System

- Maximum Performance
 - Low Friction
 - Lower Operating Pressures
 - Fast Response
 - Less Wear
- Long Cycle Life - Under pressure, radial expansion of the seal occurs to maintain sealing contact with the valve bore.
- Non-Lube Service - No lubrication required for continuous valve shifting.
- Bi-Directional Spool Seals - Common spool used for any pressure, including vacuum.

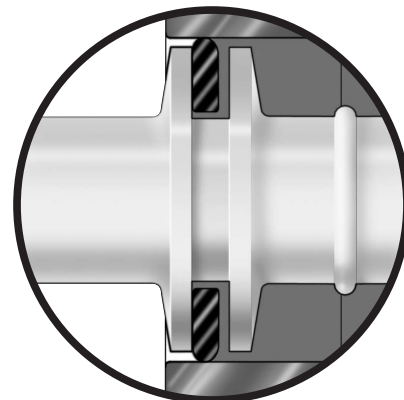

For inventory, lead times, and kit lookup, visit www.pdnplu.com

Flow Rating (Cv)

Valve size	Port size	2-Position	3-Position
HB	1/8"	0.55 Cv, C = 1.5 NI/s x bar, b = 0.25, Qn = 390 l/min, Qmax = 648 l/min	0.50 Cv, C = 1.4 NI/s x bar, b = 0.25, Qn = 360 l/min, Qmax = 595 l/min
HA	1/4"	1.1 Cv, C = 3.6 NI/s x bar, b = 0.30, Qn = 918 l/min, Qmax = 1518 l/min	1.0 Cv, C = 3.3 NI/s x bar, b = 0.30, Qn = 845 l/min, Qmax = 1395 l/min
H1	3/8"	1.5 Cv, C = 5.0 NI/s x bar, b = 0.30, Qn = 1248 l/min, Qmax = 2070 l/min	1.2 Cv, C = 4.1 NI/s x bar, b = 0.30, Qn = 1000 l/min, Qmax = 1660 l/min
H2	1/2"	3.0 Cv, C = 9.7 NI/s x bar, b = 0.35, Qn = 2520 l/min, Qmax = 4140 l/min	2.8 Cv, C = 9.0 NI/s x bar, b = 0.35, Qn = 2340 l/min, Qmax = 3860 l/min
H3	3/4"	6.0 Cv, C = 18.7 NI/s x bar, b = 0.35, Qn = 5022 l/min, Qmax = 7848 l/min	5.0 Cv, C = 15.4 NI/s x bar, b = 0.35, Qn = 4185 l/min, Qmax = 6545 l/min

Cv tested per ANSI / (NFPA) T3.21.3
 Flow tested According to ISO 6358.

Response Time (ms)**

Valve size	Port size	0 Cu. In. Chamber		## Cu. In. Chamber	
		Fill	Exhaust	Fill	Exhaust
Single Solenoid 2-Position - Air Return / Spring Assist					
HB	1/8"	28	30	141	154
HA	1/4"	24	26	77	124
H1	3/8"	28	39	124	198
H2	1/2"	38	76	149	295
H3	3/4"	56	70	163	235

**F9, 1.3 W Coil Only
 Single Solenoid 2-Position - Air Return / Spring Assist**

H1	3/8"	55	84	188	270
H2	1/2"	91	146	245	349
H3	3/4"	126	127	256	328

HB (12), HA (25), H1 (50), H2 (100), H3 (200)

** With 100 PSIG supply, time (ms) required to fill from 0 to 90 PSIG and Exhaust from 100 PSIG to 10 PSIG measured from the instant of energizing or de-energizing 24VDC solenoid.

Tested per ANSI / (NFPA) T3.21.8

Left End Plate Field Conversion

End plate kits and manifold assemblies are ordered as internal or single external pilot however field conversion is possible.

End Plate Configuration - Internal Pilot *

Insert 2 pipe plugs in locations A & B (1/8" NPT or G 1/8) as shown

Blocking off the pilot supply ports will configure the left end plate as internally piloted. Pilot pressure required to operate the H Series valves will be drawn from the supply or #1 port and no additional connections are required. Port locations C & D must be left unplugged for this option to function properly.

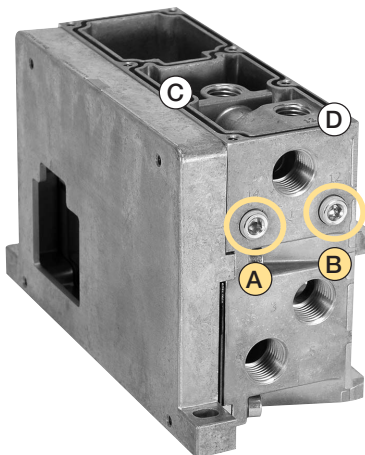

End Plate Configuration - Single External Pilot *

Insert 1 pipe plug into location C (1/4" NPT) as shown to configure the left end plate as single externally piloted.

Pilot pressure required to operate the H Series valves must be supplied to the 14 port only at location A which is internally connected to the 12 pilot.

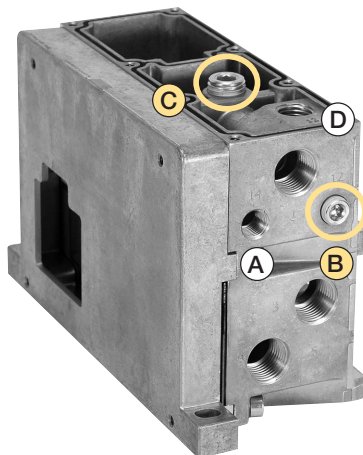

End Plate Configuration - Double External Pilot

Insert 2 pipe plugs in locations C & D (1/4" NPT) as shown to configure the left end plate as double externally piloted.

Pilot pressure required to operate the H Series valves must be supplied separately to both ports 14 and 12 (locations A and B).

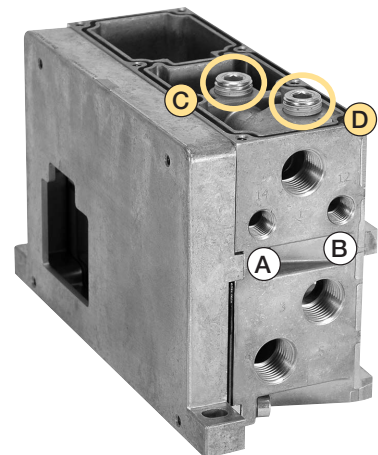

* Standard in catalog

Note: Left end plate shown with cover removed.



For inventory, lead times, and kit lookup, visit www.pdnplu.com

D125

Parker Hannifin Corporation
 Pneumatic Division
 Richland, Michigan
www.parker.com/pneumatics

D

Subbase & Manual Valves

H Series Micro

Moduflex Series

H Series ISO

Network Connectivity

DX ISOMAX Series

Valvair II Series

Common Port Regulation - Plug-in, HB & HA

Provides adjustable regulated air pressure to the valve's #1 port which gives the same pressure to both the #2 and #4 port of the manifold or subbase. The regulator is always on the 14 end of the valve.

**HB Common Port Regulator Shown -
 Single Solenoid, 14 Energized**

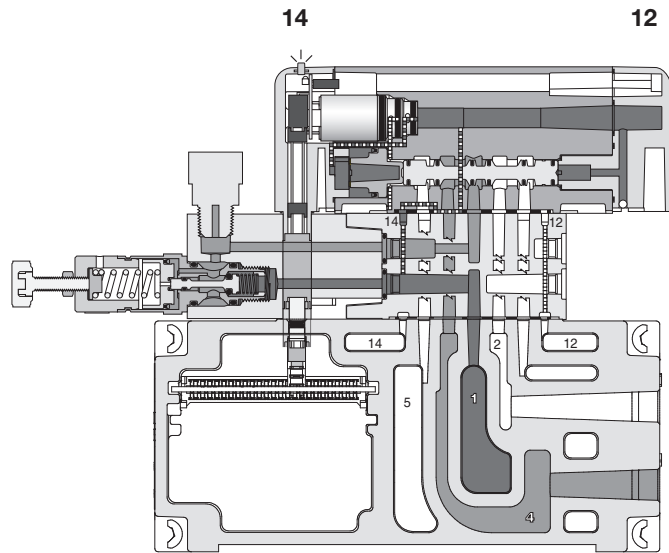
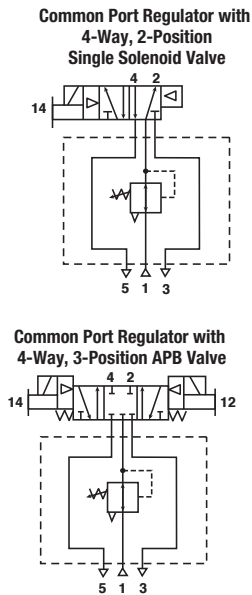

Independent Dual Port Regulation - Plug-in, HB & HA

Dual Port Regulator

Provides regulated pressure to both ports. Pressure regulation can occur out of the #2 or #4 port of the valve.

**HB Independent Dual Port Regulator Shown -
 Double Solenoid, 14 Energized**

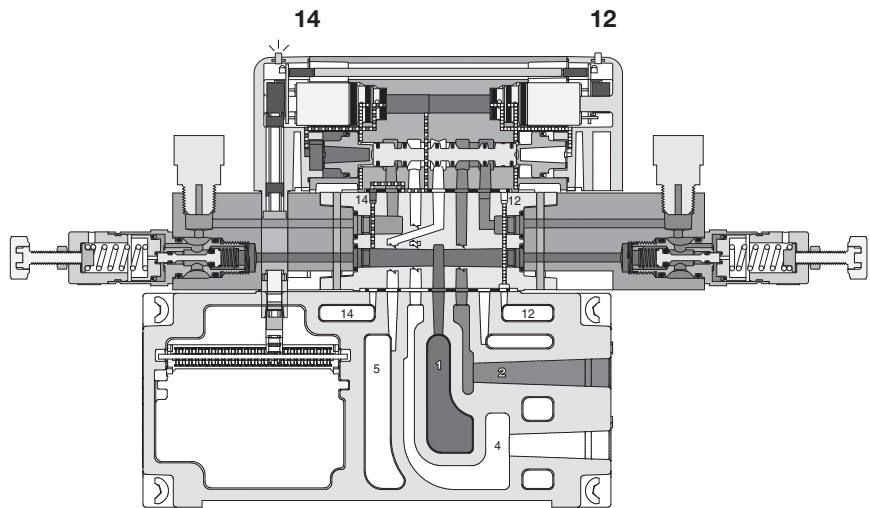
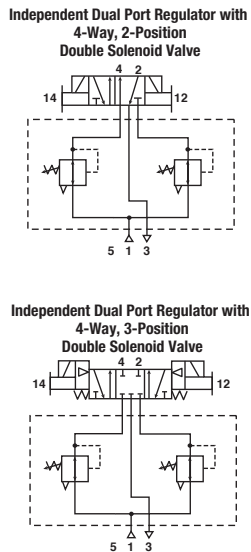

When using an Independent Pressure Sandwich Regulator, the cylinder outlet ports are reversed. The 12 end energizes the #4 port and the 14 end energizes the #2 port. The 3-Position CE and PC functions are also reversed. Do not use with Sandwich Flow Controls. Independent Port Sandwich Port Regulators combine the #3 and #5 valve exhaust ports into the #5 exhaust at the manifold/subbase interface. The #3 port flow control will control both #3 and #5 exhaust. #5 port flow control is ineffective. (See schematics above.)

D	Subbase & Manual Valves
	H Series Micro
H Series ISO	Modulflex Series
	Network Connectivity
Valvair II Series	DX ISOMAX Series
	Valvair II Series



For inventory, lead times, and kit lookup, visit www.pdnplu.com

D126

Parker Hannifin Corporation
 Pneumatic Division
 Richland, Michigan
www.parker.com/pneumatics

Common Port Regulation - Non Plug-in, HB & HA

Provides adjustable regulated air pressure to the valve's #1 port which gives the same pressure to both the #2 and #4 port of the manifold or subbase. The regulator is always on the 14 end of the valve.

HB Common Port Regulator Shown - Single Solenoid, 14 Energized

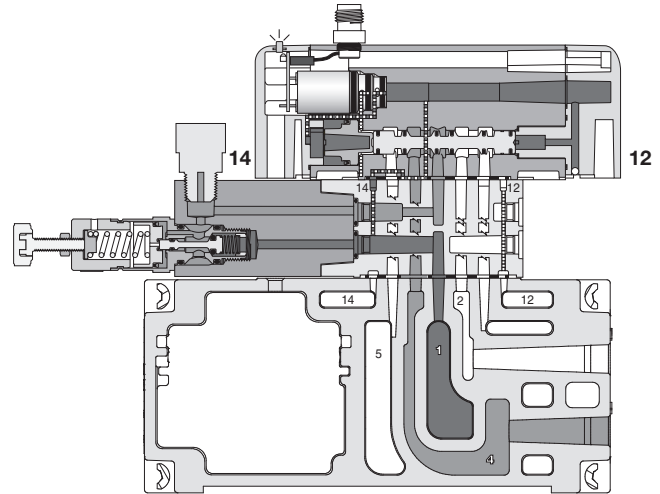
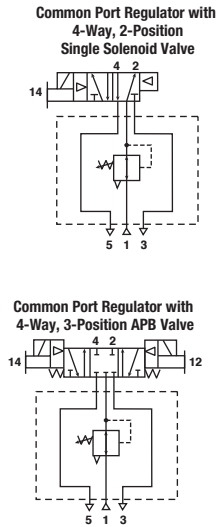

Independent Dual Port Regulation - Non Plug-in, HB & HA

Dual Port Regulator

Provides regulated pressure to both ports. Pressure regulation can occur out of the #2 or #4 port of the valve.

HB Independent Dual Port Regulator Shown - Double Solenoid, 14 Energized

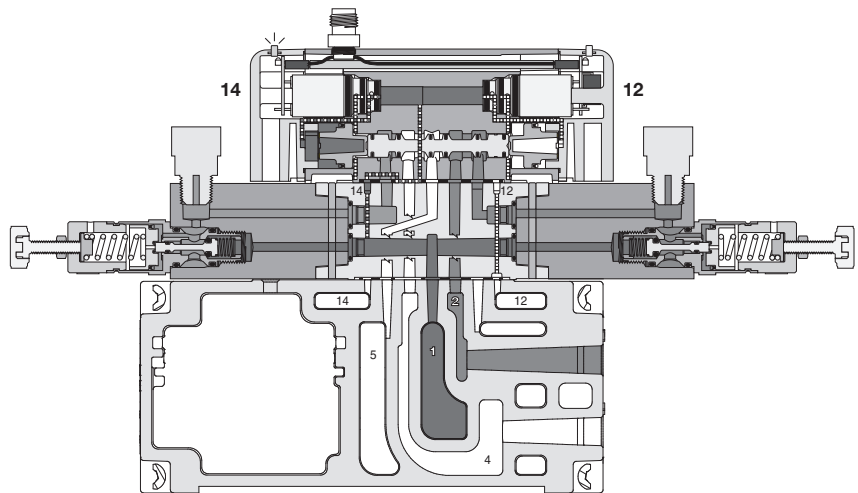
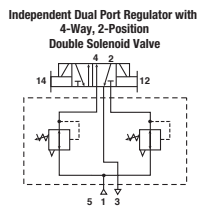

When using an Independent Pressure Sandwich Regulator, the cylinder outlet ports are reversed. The 12 end energizes the #4 port and the 14 end energizes the #2 port. The 3-Position CE and PC functions are also reversed. Do not use with Sandwich Flow Controls. Independent Port Sandwich Port Regulators combine the #3 and #5 valve exhaust ports into the #5 exhaust at the manifold/subbase interface. The #3 port flow control will control both #3 and #5 exhaust. #5 port flow control is ineffective. (See schematics on above.)

Most popular.



For inventory, lead times, and kit lookup, visit www.pdnplu.com

D127

Parker Hannifin Corporation
 Pneumatic Division
 Richland, Michigan
www.parker.com/pneumatics

D

Subbase & Manual Valves

H Series Micro

Moduflex Series

H Series ISO

Network Connectivity

DX ISOMAX Series

Valvair II Series

Common Port Regulation - Plug-in, H1, H2, H3

Provides adjustable regulated air pressure to the valve's #1 port which gives the same regulated pressure to both the #2 and #4 port of the manifold or subbase. The regulator is always on the 14 end of the valve.

**Common Port Regulator with
4-Way, 2-Position
Single Solenoid Valve**

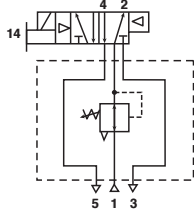

**Common Port Regulator with
4-Way, 3-Position APB Valve**

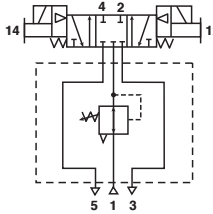

**H2 Common Port Regulator Shown -
Double Solenoid, 14 Energized, Internal Pilot**

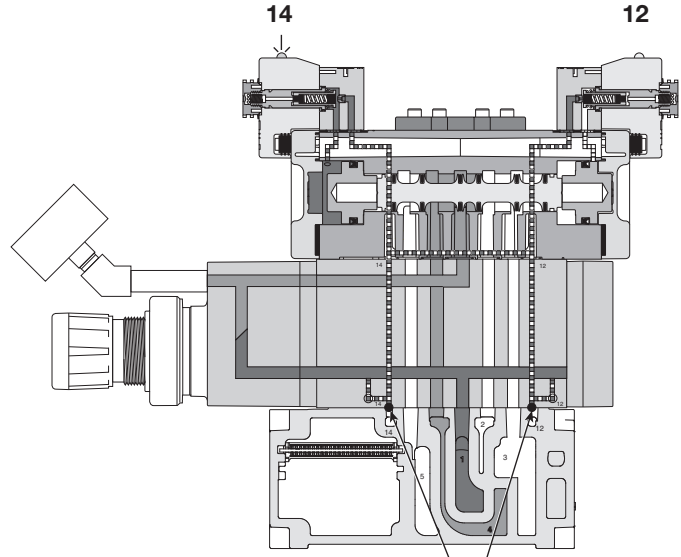

Sandwich Regulator has standard configuration of Internal Pilot with the Pilot Plug in the bottom of the I & E Pilot Holes which prevents line pressure from escaping through the manifold.

Independent Port Regulation - Plug-in, H1, H2, H3

Single Port Regulator

Provides regulated pressure to one of the ports and full line pressure to the other by use of the Line Pressure By-Pass Plate. Pressure regulation can occur out of the #4 port of the valve.

**Independent Port Regulator with
4-Way, 3-Position All Ports Blocked Valve**

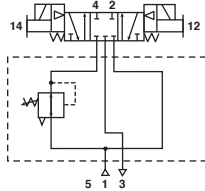

**Independent Port Regulator with 4-Way,
3-Position, Inlet to Cylinder Function**

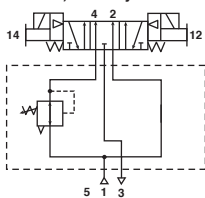

**Independent Port Regulator with 4-Way,
3-Position, Cylinder to Exhaust Function**

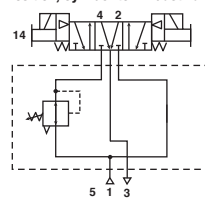

CAUTION: Requires 4-Way, 3-Position, Cylinder to Exhaust Valve

CAUTION: Requires 4-Way, 3-Position, Inlet to Cylinder Valve

**H1 Independent Port Regulator Shown -
Double Solenoid, De-energized, Internal Pilot**

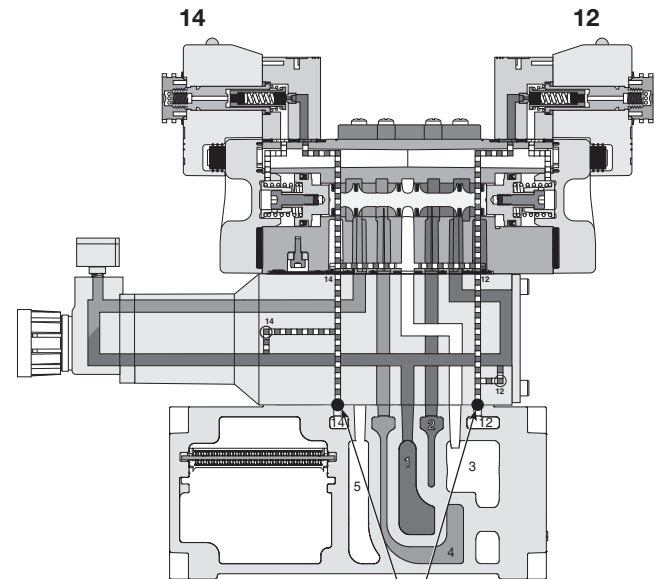

Sandwich Regulator has standard configuration of Internal Pilot with the Pilot Plug in the bottom of the I & E Pilot Holes which prevents line pressure from escaping through the manifold.

When using an Independent Pressure Sandwich Regulator, the cylinder outlet ports are reversed. The 12 end energizes the #4 port and the 14 end energizes the #2 port. The 3-Position CE and PC functions are also reversed. Do not use with Sandwich Flow Controls. Independent Port Sandwich Port Regulators combine the #3 and #5 valve exhaust ports into the #5 exhaust at the manifold/subbase interface. The #3 port flow control will control both #3 and #5 exhaust. #5 port flow control is ineffective. (See schematics above.)

D	Subbase & Manual Valves
H Series Micro	
Modulflex Series	
H Series ISO	
Network Connectivity	
DX ISOMAX Series	
Valvair II Series	



For inventory, lead times, and kit lookup, visit www.pdnplu.com

Independent Dual Port Regulation - Plug-in, H1, H2, H3

Dual Port Regulator

Provides regulated pressure to both ports. Pressure regulation can occur out of the #2 or #4 port of the valve.

**H1 Independent Dual Port Regulator Shown -
Double Solenoid, 14 Energized, Internal Pilot**

Independent Dual Port Regulator with
4-Way, 2-Position
Double Solenoid Valve

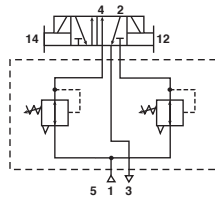

Independent Dual Port Regulator with
4-Way, 3-Position
Double Solenoid Valve

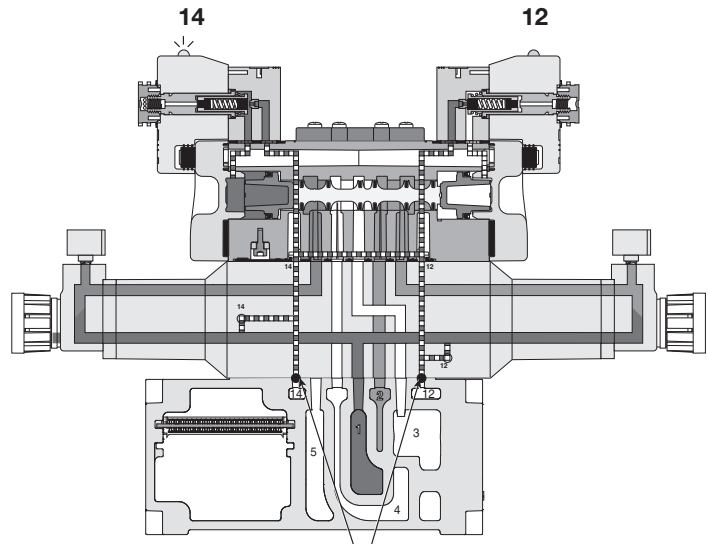
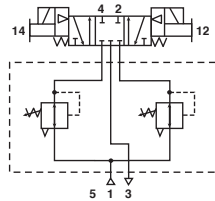

Sandwich Regulator has standard configuration of Internal Pilot with the Pilot Plug in the bottom #12 and #14 Pilot Hole which prevents line pressure from escaping through the manifold.

When using an Independent Pressure Sandwich Regulator, the cylinder outlet ports are reversed. The 12 end energizes the #4 port and the 14 end energizes the #2 port. The 3-Position CE and PC functions are also reversed. Do not use with Sandwich Flow Controls. Independent Port Sandwich Port Regulators combine the #3 and #5 valve exhaust ports into the #5 exhaust at the manifold/subbase interface. The #3 port flow control will control both #3 and #5 exhaust. #5 port flow control is ineffective. (See schematics on above.)

D	Subbase & Manual Valves
H Series Micro	Modulflex Series
H Series ISO	Network Connectivity
DX ISOMAX Series	Valvair II Series



For inventory, lead times, and kit lookup, visit www.pdnplu.com

D129

Parker Hannifin Corporation
Pneumatic Division
Richland, Michigan
www.parker.com/pneumatics

Common Port Regulation - Non Plug-in, H1, H2, H3

Provides adjustable regulated air pressure to the valve's #1 port which gives the same regulated pressure to both the #2 and #4 port of the manifold or subbase. The regulator is always on the 14 end of the valve.

Common Port Regulator with 4-Way, 2-Position Single Solenoid Valve

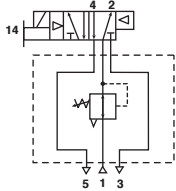

Common Port Regulator with 4-Way, 3-Position APB Valve

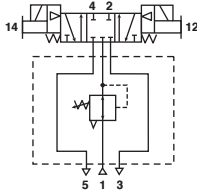

H2 Common Port Regulator Shown - Double Solenoid, 14 Energized, Internal Pilot

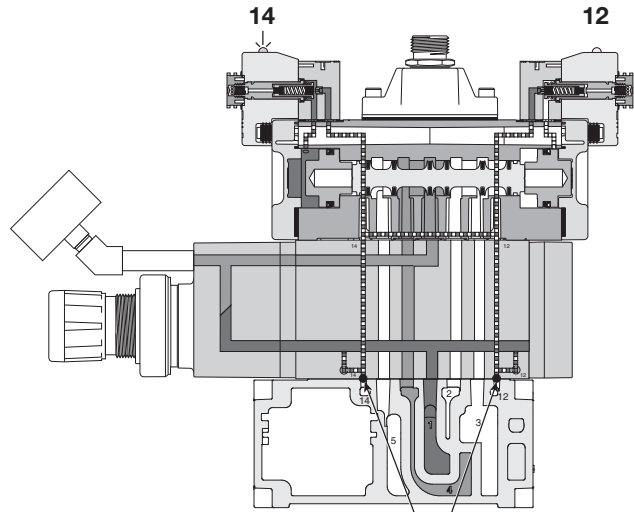

Sandwich Regulator has standard configuration of Internal Pilot with the Pilot Plug in the bottom of the I & E Pilot Holes which prevents line pressure from escaping through the manifold.

Independent Port Regulation - Non Plug-in, H1, H2, H3

Single Port Regulator

Provides regulated pressure to one of the ports and full line pressure to the other by use of the Line Pressure By-Pass Plate. Pressure regulation can occur out of the #4 port of the valve.

Independent Port Regulator with 4-Way, 3-Position All Ports Blocked Valve

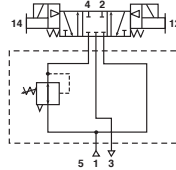

Independent Port Regulator with 4-Way, 3-Position, Inlet to Cylinder Function

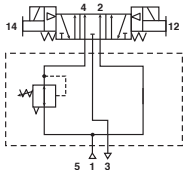

⚠ CAUTION: Requires 4-Way, 3-Position, Cylinder to Exhaust Valve

Independent Port Regulator with 4-Way, 3-Position, Cylinder to Exhaust Function

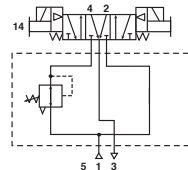

⚠ CAUTION: Requires 4-Way, 3-Position, Inlet to Cylinder Valve

H1 Independent Port Regulator Shown - Double Solenoid, De-energized, Internal Pilot

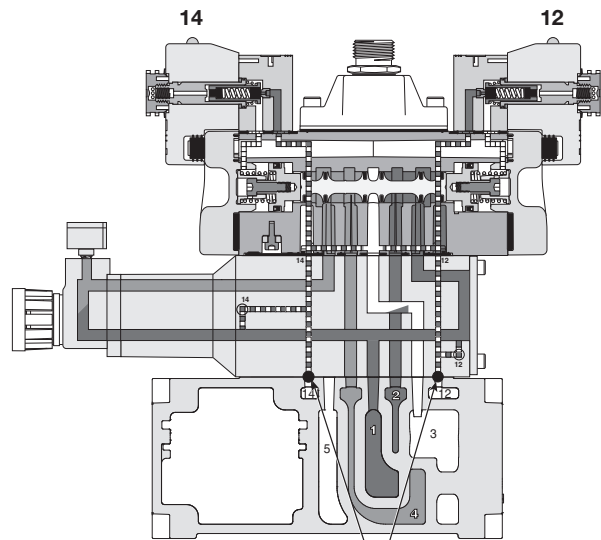

Sandwich Regulator has standard configuration of Internal Pilot with the Pilot Plug in the bottom #12 and #14 Pilot Hole which prevents line pressure from escaping through the manifold.

When using an Independent Pressure Sandwich Regulator, the cylinder outlet ports are reversed. The 12 end energizes the #4 port and the 14 end energizes the #2 port. The 3-Position CE and PC functions are also reversed. Do not use with Sandwich Flow Controls. Independent Port Sandwich Port Regulators combine the #3 and #5 valve exhaust ports into the #5 exhaust at the manifold/subbase interface. The #3 port flow control will control both #3 and #5 exhaust. #5 port flow control is ineffective. (See schematics on above.)

D	Subbase & Manual Valves
H Series Micro	
Modulflex Series	
H Series ISO	
Network Connectivity	
DX ISOMAX Series	
Valvair II Series	



For inventory, lead times, and kit lookup, visit www.pdnplu.com

Independent Dual Port Regulation - Non Plug-in, H1, H2, H3

Dual Port Regulator

Provides regulated pressure to both ports. Pressure regulation can occur out of the #2 or #4 port of the valve.

H1 Independent Dual Port Regulator Shown - Double Solenoid, 14 Energized, Internal Pilot

Independent Dual Port Regulator with 4-Way, 2-Position Double Solenoid Valve

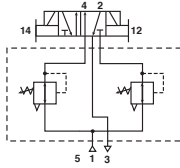

Independent Dual Port Regulator with 4-Way, 3-Position Double Solenoid Valve

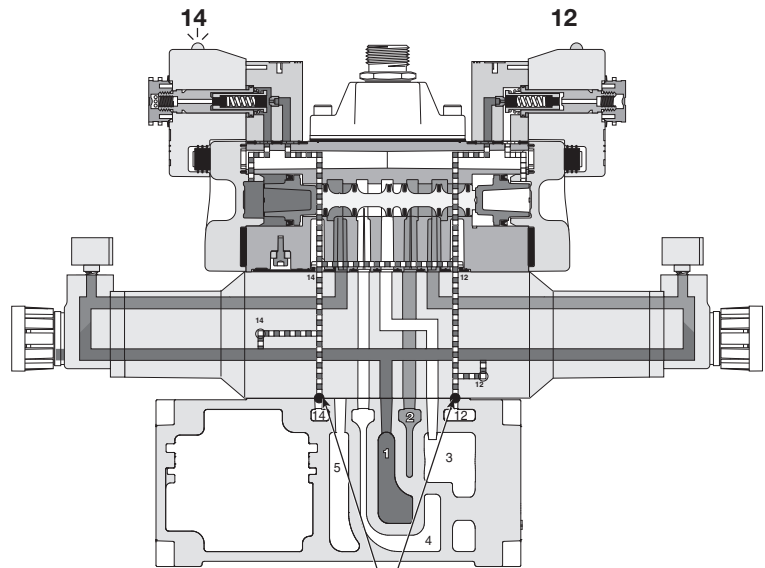
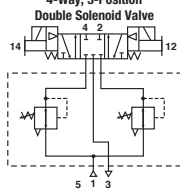

Sandwich Regulator has standard configuration of Internal Pilot with the Pilot Plug in the bottom #12 and #14 Pilot Hole which prevents line pressure from escaping through the manifold.

When using an Independent Pressure Sandwich Regulator, the cylinder outlet ports are reversed. The 12 end energizes the #4 port and the 14 end energizes the #2 port. The 3-Position CE and PC functions are also reversed. Do not use with Sandwich Flow Controls. Independent Port Sandwich Port Regulators combine the #3 and #5 valve exhaust ports into the #5 exhaust at the manifold/subbase interface. The #3 port flow control will control both #3 and #5 exhaust. #5 port flow control is ineffective. (See schematics on above.)

D
Subbase & Manual Valves
H Series Micro
Moduflex Series
H Series ISO
Network Connectivity
DX ISOMAX Series
Valvair II Series



For inventory, lead times, and kit lookup, visit www.pdnplu.com

D131

Parker Hannifin Corporation
 Pneumatic Division
 Richland, Michigan
www.parker.com/pneumatics

Minimum Operating Voltage

	HB	HA	H1	H2	H3
MOV (24VDC)	20.4	20.4	20.4	20.4	20.4
MOV (120VAC)	102*	102*	102	102	102

* 120VAC coils have a dropout voltage of 10VAC when used with solid state relays. A pull-down resistor may be necessary.

P2H IO-Link

Class B, M12 pin

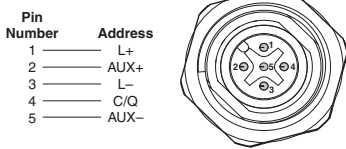

Class A, M12 pin



Class A, Power IN / OUT 7/8 pin

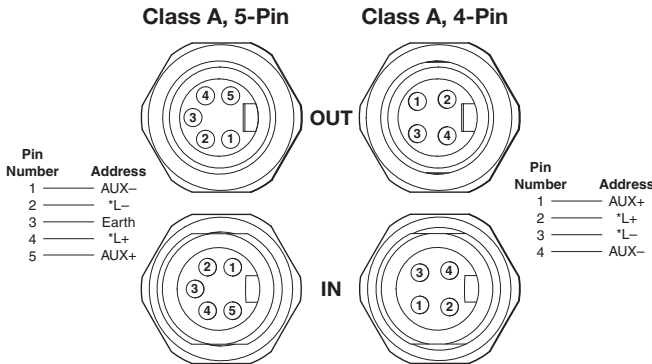

* 7/8" logic power has no connection to internal P2H unit but does carryover to OUT 7/8" connector (for jumper logic power only). Logic power for P2H unit will be supplied from M12 (pin 1 & 3).

19-Pin Connector, Round Brad Harrison

Male, face view

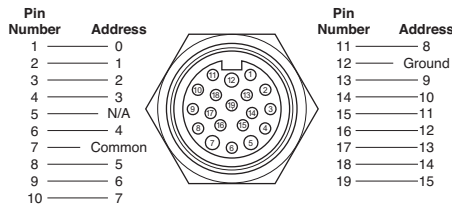

19-Pin Round Cable Specifications

Common Pin "7" is rated for 8 amps. Cable common wire must be greater than total amperage of solenoids on Add-A-Fold assembly.

Example: 8 segment manifold, 16 solenoids, 120VAC - 16 x .039 amps = .63 total amp rating.

NEMA 4 rated with properly assembled NEMA 4 rated cable.

M23, Round Connector

Male 12-pin connector, face view

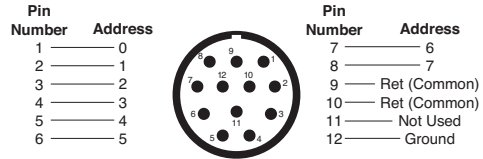

Male 19-pin connector, view into end plate

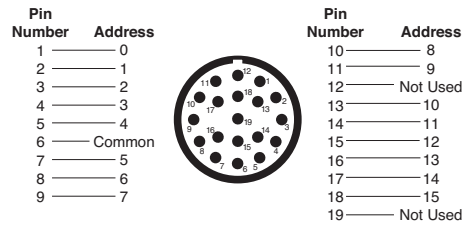

25-Pin, D-Sub Connector

Male, view into end plate connector

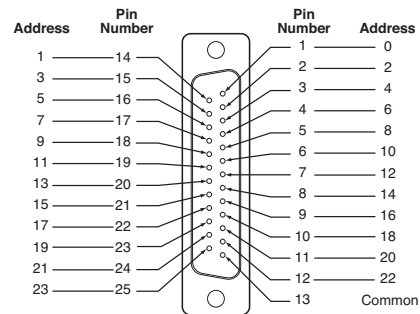

Female, view into cable connector

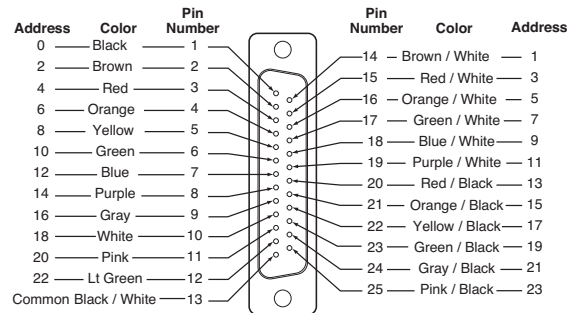

Description	Length	Part number
25-pin, D-sub cable, IP20	3 Meters	P8LMH25M3A
25-pin, D-sub cable, IP20	9 Meters	SCD259D
25-pin, D-sub cable, IP65	3 Meters	SCD253W
25-pin, D-sub cable, IP65	9 Meters	SCD259WE



D
 Subbase & Manual Valves
 H Series Micro
 Modulflex Series
 H Series ISO
 Network Connectivity
 DX ISOMAX Series
 Valvair-II Series



For inventory, lead times, and kit lookup, visit www.pdnplu.com

Subbase Wiring

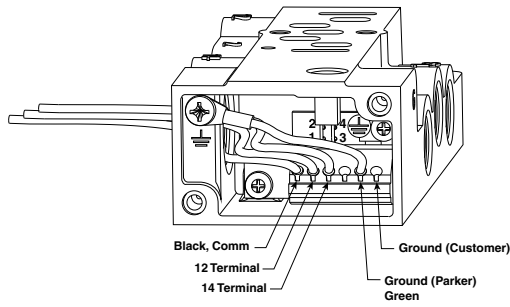

All commons internally connected on terminal strip

Connections	14 Solenoid	12 Solenoid
Valves with Wires	Black Wires	Red Wires
Valves with Terminal Block (Will accept 18 to 24 Gauge Wires)	14 and Com Terminals	12 and Com Terminals

Manifold Wiring - Size 3

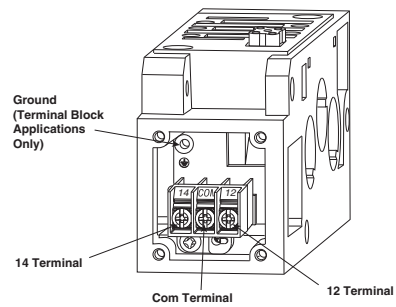

Terminal Box Wiring (H Universal)

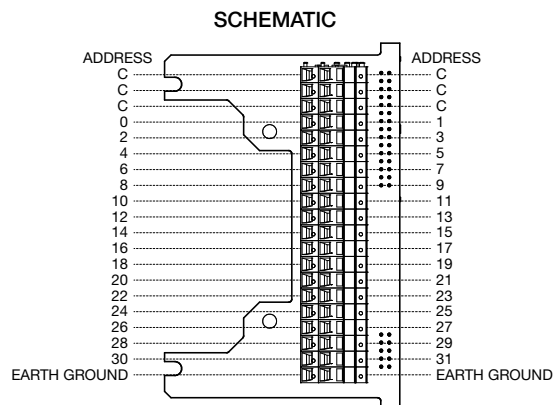
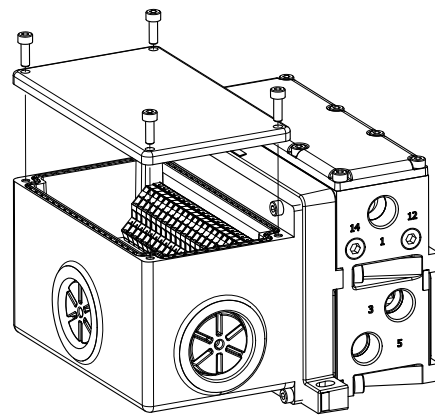
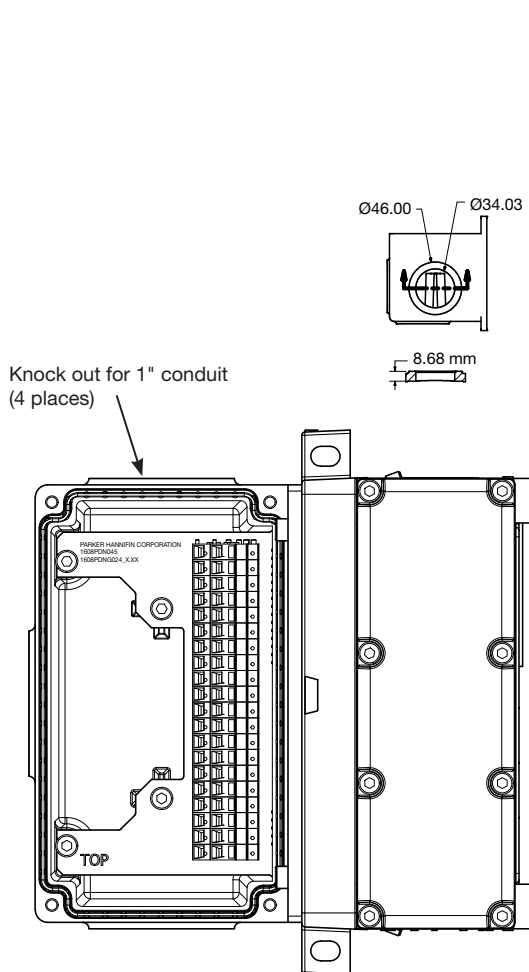

All commons internally connected on terminal strip

D

Subbase & Manual Valves

H Series Micro

Moduflex Series

H Series ISO

Network Connectivity

DX ISOMAX Series

Valvair II Series



For inventory, lead times, and kit lookup, visit www.pdnplu.com

D133

Parker Hannifin Corporation
 Pneumatic Division
 Richland, Michigan
www.parker.com/pneumatics

Electrical Connectors - Size 1, 2 & 3

5599-1 CNOMO

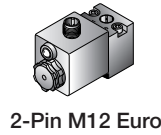

5599-2

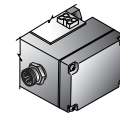
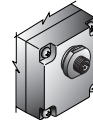

5599-1 AUTO

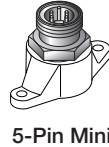
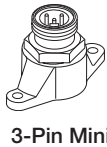

30mm Square 3-Pin – ISO 4400, DIN 43650A (Use with Enclosure “A”)

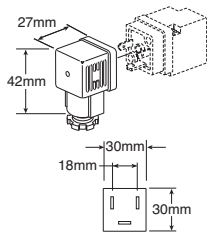

Description	Connector with 6' (2m) cord	Connector
Unlighted	PS2028JCP	PS2028BP
Light – 6-48V. 50/60Hz. 6-48VDC	PS2032J79CP*	PS203279BP
Light – 120V/60Hz	PS2032J83CP*	PS203283BP

* LED with surge suppression.

Note: Max ø6.5mm cable size required for connector w/o 6' (2m) cord. IP65 rated when properly installed.

Engineering data:

Conductors: 2 poles plus ground; cable range (connector only): 8 to 10mm (0.31 To 0.39 Inch); contact spacing: 18mm

D

Subbase & Manual
Valves

H Series
Micro

Modulflex
Series

H Series
ISO

Network
Connectivity

DX ISOMAX
Series

Valvair II
Series

7/8" Mini Power Cables - use with 5-pin mini connector

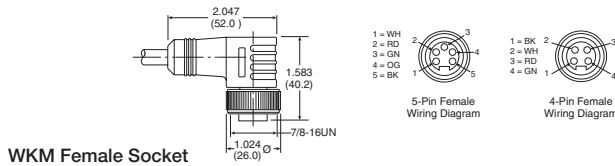
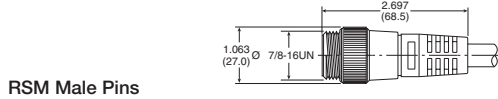
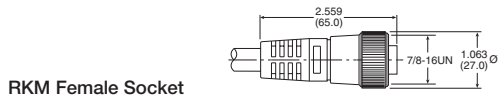

Description	Part number
4-pin female to flying lead cable, 5 meters, TPE	RKM 46-5M/S1587
5-pin female to flying lead cable, 5 meters, TPE	RKM 56-5M/S1587
4-pin male to female cable, TPE	RSM RKM 46-x/S1587
5-pin male to female cable, TPE	RSM RKM 56-x/S1587
4-pin right angle female to flying lead cable, 5 meters, TPE	WKM 46-5M/S1587
5-pin right angle female to flying lead cable, TPE	WKM 56-5M/S1587

Where x = 2, 4, 5, 6, 8, 10 meter standard lengths

M12 A-code Cables - use with 4-pin micro, 2-pin micro

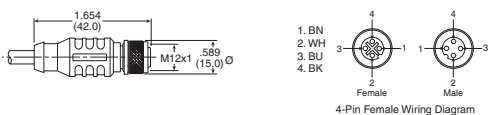

Description	Part number
4-pin female to flying lead cable, PVC	RKC 4.4T-1
4-pin male to flying lead cable, PVC	RSC 4.4T-*
4-pin male to female cable, PVC	RKC 4.4T-*/RSC 4.4T
5-pin female to flying lead cable, TPE	RKC 4.5T-*/S1587
5-pin male to flying lead cable, TPE	RSC 4.5T-4/S1587
5-pin male to female cable, TPE	RKC 4.5T-*/RSC 4.5T/S1587

Where * = 1, 2, 3, 4 meter standard lengths



For inventory, lead times, and kit lookup, visit www.pdnplu.com

Automotive Connection – Wiring Options

‘C’ Chrysler Connection

5-Pin Male / Single Solenoid
 (Encl. Option 3, Auto Option C)

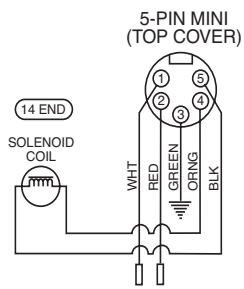

5-Pin Male / Double Solenoid
 (Encl. Option 3, Auto Option C)

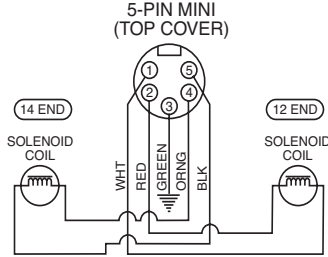

4-Pin Male / Single Solenoid
 (Encl. Option 2, Auto Option C)

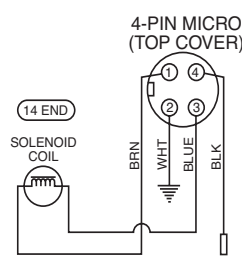

4-Pin Male / Double Solenoid
 (Encl. Option 2, Auto Option C)

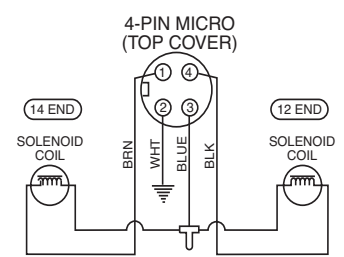

‘F’ SAE / Ford Wiring

5-Pin Male / Single Solenoid
 (Encl. Option 3, Auto Option F)

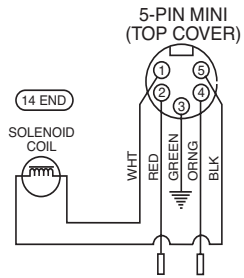

5-Pin Male / Double Solenoid
 (Encl. Option 3, Auto Option F)

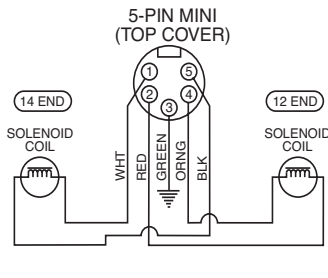

ISO 20401
4-Pin Male / Single Solenoid
 (Encl. Option 2, Auto Option F)

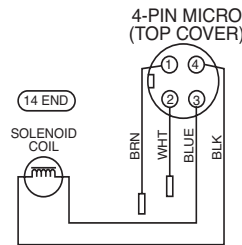

ISO 20401
4-Pin Male / Double Solenoid
 (Encl. Option 2, Auto Option F)

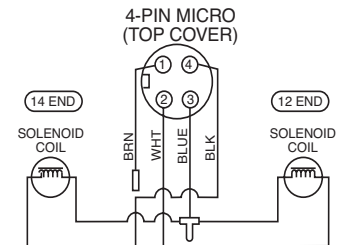

‘G’ GM Wiring

5-Pin Male / Single Solenoid
 (Encl. Option 3, Auto Option G)

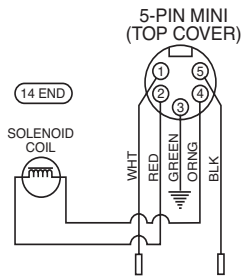

5-Pin Male / Double Solenoid
 (Encl. Option 3, Auto Option G)

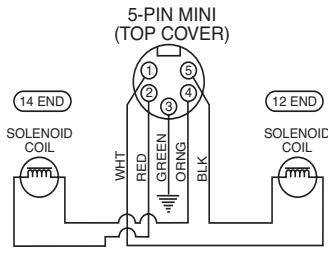

4-Pin Male / Single Solenoid
 (Encl. Option 2, Auto Option G)

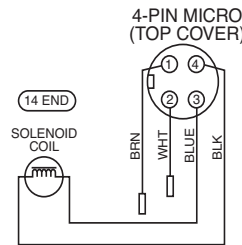

4-Pin Male / Double Solenoid
 (Encl. Option 2, Auto Option G)

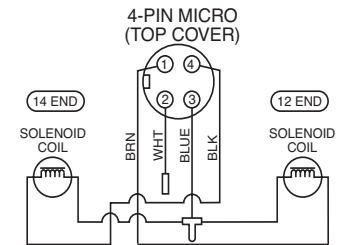

CNOMO Connection - Wiring Options

2-Pin Male / Single Solenoid
 (Encl. Option 6, Auto Option F)

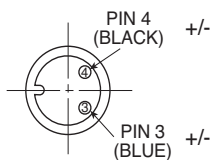

3-Pin Male / Single Solenoid
 (Encl. Option 1, Auto Options C, F & G)

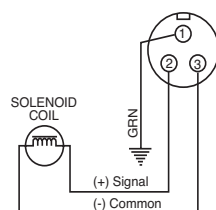

Technical Data / Accessories

Maximum Number of Solenoids
(Maximum energized simultaneously)

	Voltage code	25-pin D-sub	19-pin Brad Harrison	12-Pin M23	19-pin M23	P2H IO-Link Node	P2H Ethernet Node	PCH Portal	Turck Network Portal	
									16 Outputs	32 Outputs
HA & HB										
24VDC	G9 (1.0 watt)	24 (24)	16 (16)	8 (8)	16 (16)	24 (24)	32 (32)	32 (32)	16 (16)	32 (32)
120VAC*	23 (1.0 VA)	24 (24)	16 (16)	8 (8)	16 (16)	N/A	N/A	N/A	N/A	N/A
H1, H2										
12VDC	45 (2.4 watt)	24 (13)	16 (13)	8 (8)	16 (13)	N/A	N/A	N/A	N/A	N/A
24VAC*	42 (4.0 VA)	24 (24)	16 (16)	8 (8)	16 (16)	N/A	N/A	N/A	N/A	N/A
24VDC	B9 (3.2 watt)	24 (24)	16 (16)	8 (8)	16 (16)	24 (24)†	32 (32)	32 (32)	16 (16)	32 (32)
24VDC	F9 (1.3 watt)	24 (24)	16 (16)	8 (8)	16 (16)	24 (24)†	32 (32)	32 (32)	16 (16)	32 (32)
120VAC*	23 (4.5 VA)	24 (24)	16 (16)	8 (8)	16 (16)	N/A	N/A	N/A	N/A	N/A
H3 Only										
12VDC	45 (2.4 watt)	24 (13)	16 (13)	8 (8)	16 (13)	N/A	N/A	N/A	N/A	N/A
24VAC*	42 (4.0 VA)	24 (24)	16 (16)	8 (8)	16 (16)	N/A	N/A	N/A	N/A	N/A
24VDC	B9 (3.2 watt)	24 (20)	16 (16)	8 (8)	16 (16)	24 (24)†	32 (32)**	N/A	16 (16)	24 (21)
24VDC	F9 (1.3 watt)	24 (24)	16 (16)	8 (8)	16 (16)	24 (24)†	32 (32)**	N/A	16 (16)	24 (24)
120VAC*	23 (4.5 VA)	24 (24)	16 (16)	8 (8)	16 (16)	N/A	N/A	N/A	N/A	N/A

* Not CSA certified for 25-pin, D-sub option.

** Must use H Universal manifold end plate kit with transition kit to H3 manifold segments.

† Use Type A IO-Link module for 24 outputs simultaneously.

I/O Addressing Examples

HB, HA, H1, H2 - Five Segment Manifold Example

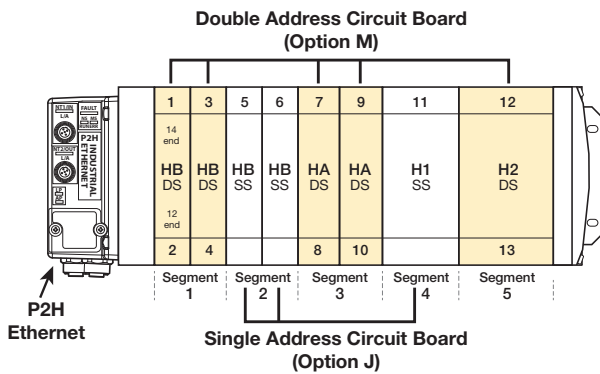

HB, HA, H1, H2 - Nine Segment Manifold with Intermediate Supply Example

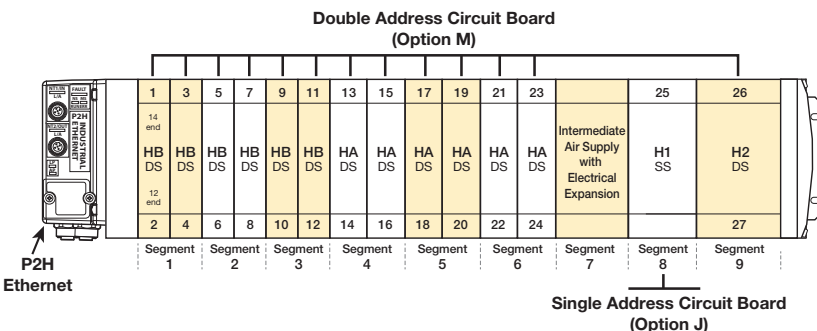

Notes: SS = Single Solenoid Valve
DS = Double Solenoid Valve
First output address is the #14 end of the valve closest to the valve driver module.

Intermediate Module with Electrical Expansion to 25th address required for manifolds with greater than 24 solenoid addresses.

D
 Subbase & Manual Valves
 H Series Micro
 Modflex Series
 H Series ISO
 Network Connectivity
 DX ISOMAX Series
 Valvair II Series



For inventory, lead times, and kit lookup, visit www.pdnplu.com

D136

Parker Hannifin Corporation
Pneumatic Division
Richland, Michigan
www.parker.com/pneumatics

Accessories

5599-2 & 5599-1 AUTO Solenoid Kits

Valve size	Voltage code	Coil kit number
H1, H2 & H3	42 (24VAC)	PS404142P
	45 (12VDC)	PS404145P
	B9 (24VDC), 3.2 watt	PS4041B9P
	F9 (24VDC), 1.3 watt	PS4041F9P
	23 (120VAC)	PS404123P
	57 (240VAC)	PS404157P

Quantity 1

Pilot Operator - CNOMO

Valve size		Kit number
H1, H2 & H3	Locking	PS4052CP
	Non-locking	PS4053CP
	Non-locking †	PS4054CP

† F9 (1.3 watt) coil option only.

Manifold Hardware Kits

Valve size	Kit number
HB, HA, H1, H2 *	PSHU10P
H3 **	PS4212P

* Quantity 20

** Quantity 12

Valve Bolt Kits

Valve size	Kit number
HB	PS5687P
HA	PS5587P
H1	PS4087DP
H2	PS4187DP
H3	PS4287DP

Quantity 12

Valve to Base Gasket Kits

Valve size	Standard	Remote pilot	Dual pressure #3	Dual pressure #5
HB	PS5605P*	—	—	—
HA	PS5505P*	—	—	—
H1	PS4005DP	PS4006DP	PS40D3DP	—
H2	PS4105DP	PS4106DP	PS41D3DP	PS41D5DP
H3	PS4205DP	PS4206DP	PS42D3DP	PS42D5DP

Quantity 1

* Quantity 10

5599-1 CNOMO Solenoid Kits

Voltage code	3-pin, 30mm 'L' coil kit	2-pin, M12 Euro '6' coil kit
19	—	PS2828619P
42	P2FCA442	—
45	P2FCA445	—
49	P2FCA449	—
53	P2FCA453	—
57	P2FCA457	—

Quantity 1

Body Service Kits



Valve size	2-position	3-position		
		APB	CE	PC
HB	PS5601P	PS5602P	PS5603P	PS5604P
HA	PS5501P	PS5502P	PS5503P	PS5504P
H1	PS4001CP	PS4002CP	PS4003CP	PS4004CP
H2	PS4101CP	PS4102CP	PS4103CP	PS4104CP
H3	PS4201CP	PS4202CP	PS4203CP	PS4204CP

HB / HA Kit Includes: Spool assembly with seals.

H1, H2, H3 Kit Includes: Spool assembly with seals, all piston seals, return spring, pilot selector gasket, coil to end cap gasket.

Quantity 1

Pilot Select Gasket Kits

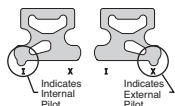
	Valve size	Part number
	HB	PS5605P
	HA	PS5505P
	H1, H2 & H3	PS4007P

Quantity 10

Regulator Kits

Valve size	Part number
H1	PS4039P
H2, H3	PS4139P



For inventory, lead times, and kit lookup, visit www.pdnplu.com

Accessories

Regulator & Flow Control Mounting Studs

Valve type	Type	Part number
HB	Flow Control & Regulator	PS5636P
HA	Flow Control & Regulator	PS5536P
H1	Flow Control	PS4036P
	Regulator	PS4040P
H2	Flow Control	PS4136P
	Regulator	PS4140P
H3	Flow Control	PS4236P
	Regulator	PS4240P

Quantity 12

Regulator Gauge Kits – Size H1, H2 & H3

Gauge type	Part number
1" Face Air - Standard	
0 to 60 PSIG	PS4051060BP
0 to 160 PSIG	PS4051160BP
1-1/2" Face Air - Large*	
0 to 60 PSIG	PS4053060BP
0 to 160 PSIG	PS4053160BP
1-1/2" Face Liquid*	
0 to 160 PSIG	PS4052160BP

* Includes brass pipe fitting extensions
Quantity 1

Pilot By-Pass Plate

Valve size	Part number
H1, H2, H3	PS4051CP

Quantity 10

Installation Bracket

Bracket	Part number
	Bracket and Bolt (Quantity 2) PSHU60P

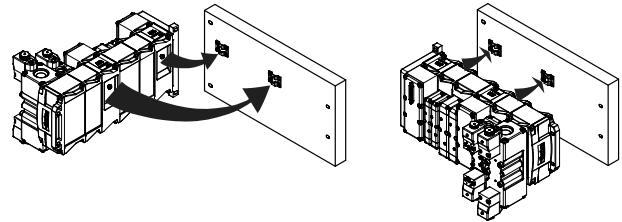

D
Subbase & Manual Valves
H Series Micro
Modulflex Series
H Series ISO
Network Connectivity
DX ISOMAX Series
Valvair II Series



For inventory, lead times, and kit lookup, visit www.pdnplu.com

H Series ISO 15407-2, Plug-in, Size 18mm (HB)

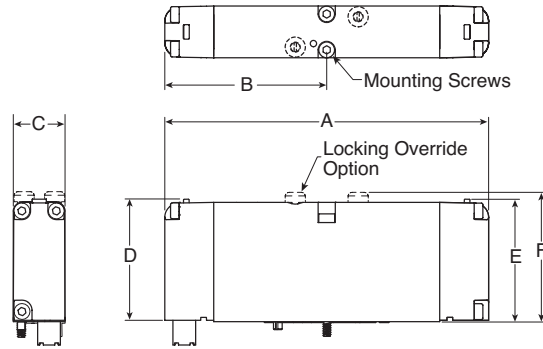

18mm Dimensions

A	B	C	D
4.43 (113)	2.22 (56)	.72 (18)	1.98 (50)
E	F		
1.68 (43)	1.77 (45)		

Inches (mm)

H Series ISO 15407-2, Plug-in, Size 26mm (HA)

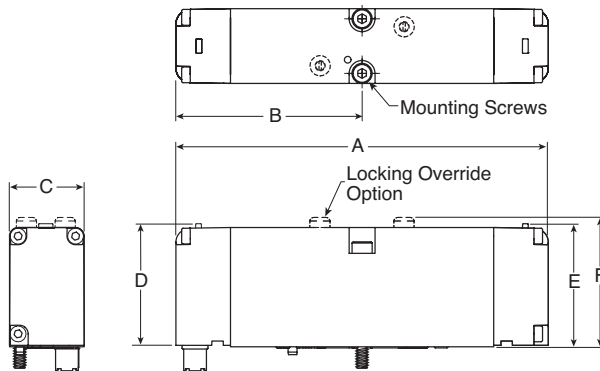

26mm Dimensions

A	B	C	D
5.10 (130)	2.55 (65)	1.02 (26)	1.98 (50)
E	F		
1.68 (43)	1.77 (45)		

Inches (mm)

H Series ISO 15407-1, Non Plug-in, Size 18mm (HB)

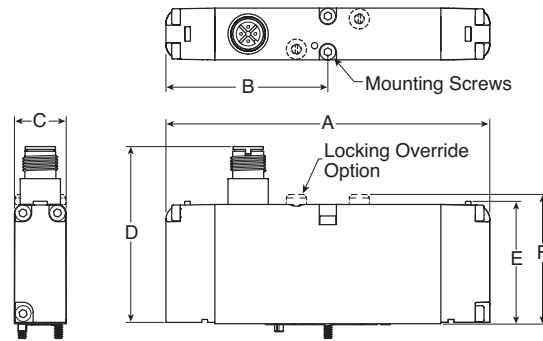

18mm Dimensions

A	B	C	D
4.43 (113)	2.22 (56)	.72 (18)	2.40 (61)
E	F		
1.68 (43)	1.77 (45)		

Inches (mm)

H Series ISO 15407-1, Non Plug-in, Size 26mm (HA)

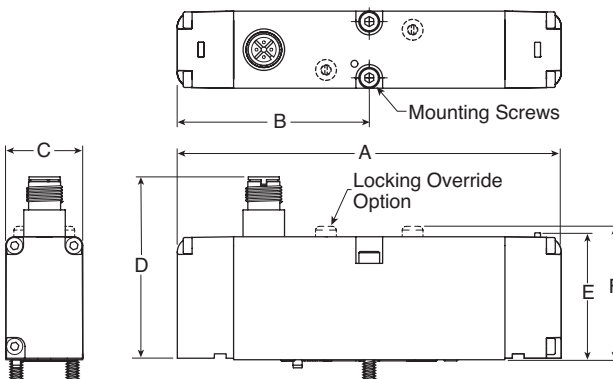

26mm Dimensions

A	B	C	D
5.10 (130)	2.55 (65)	1.02 (26)	2.40 (61)
E	F		
1.68 (43)	1.77 (45)		

Inches (mm)



For inventory, lead times, and kit lookup, visit www.pdnplu.com

D139

Parker Hannifin Corporation
 Pneumatic Division
 Richland, Michigan
www.parker.com/pneumatics

D

Subbase & Manual Valves

H Series Micro

Moduflex Series

H Series ISO

Network Connectivity

DX ISOMAX Series

Valvair II Series

Dimensional Data

H Series ISO 5599-2

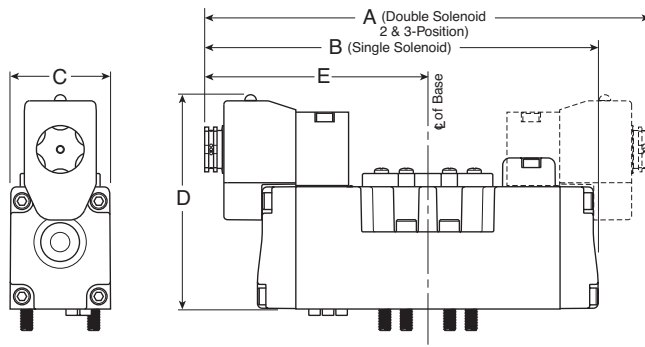

H1 Valves Shown

H1 Dimensions

A	A ₁	B	C
7.32 (186)	5.59 (142)	6.46 (164)	1.65 (42)
D	D ₁	D ₂	D ₃
3.54 (90)	4.29 (109)	4.29 (109)	2.50 (63.5)
D ₄	E	E ₁	
2.48 (63)	3.66 (93)	2.80 (71)	

Inches (mm)

H Series ISO 5599-1 Auto

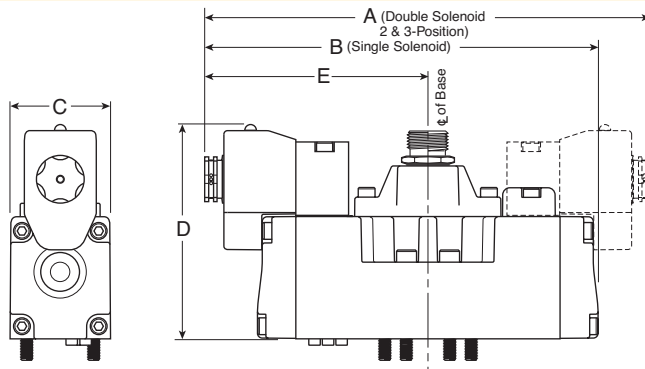

H2 Dimensions

A	A ₁	B	C
8.35 (212)	6.62 (168)	7.48 (190)	2.17 (55)
D	D ₁	D ₂	D ₃
4.05 (103)	4.80 (122)	4.57 (116)	2.99 (76)
E	E ₁		
4.17 (106)	3.31 (84)		

Inches (mm)

H Series ISO 5599-1 CNOMO

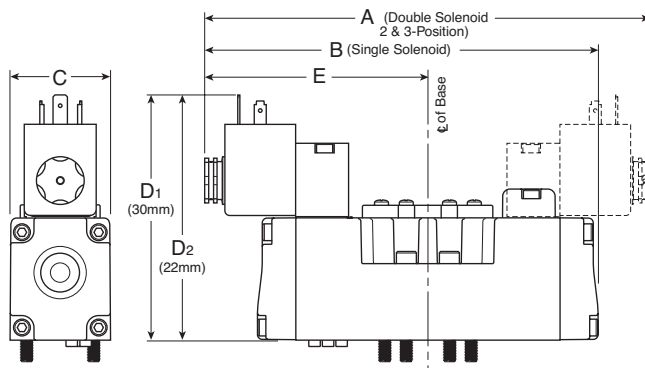

H3 Dimensions

A	A ₁	B	C
9.68 (246)	6.98 (196.7)	8.68 (220)	2.17 (65.5)
D	D ₁	D ₂	D ₃
4.05 (103)	4.80 (122)	4.57 (116)	2.99 (76)
E	E ₁		
4.74 (121)	3.49 (89)		

Inches (mm)

H Series ISO 5599-2 / 5599-1 Remote Pilot

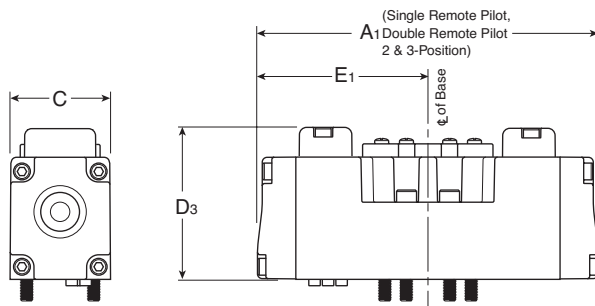

D

Subbase & Manual
Valves

H Series
Micro

Modulflex
Series

H Series
ISO

Network
Connectivity

DX ISOMAX
Series

Valvair II
Series



For inventory, lead times, and kit lookup, visit www.pdnplu.com

D140

Parker Hannifin Corporation
Pneumatic Division
Richland, Michigan
www.parker.com/pneumatics

HB Series ISO 15407-1, Size 18mm (HB) Single Subbase

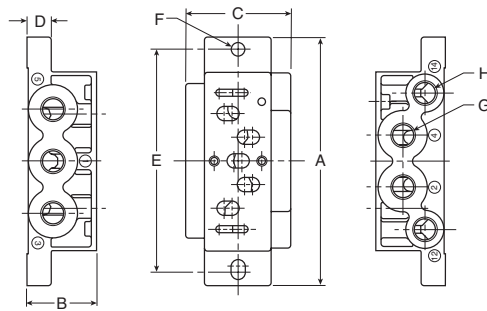

HB Dimensions (PL02)

A	B	C	D
3.15 (80)	.87 (22)	1.06 (27)	.31 (8)
E	F	G	H
2.76 (70)	.216 Dia. (Ø 5.5)	1/8	M5

Inches (mm)

H Series ISO 15407-2 & 15407-1 Size 26mm (HA), Plug-in Subbases

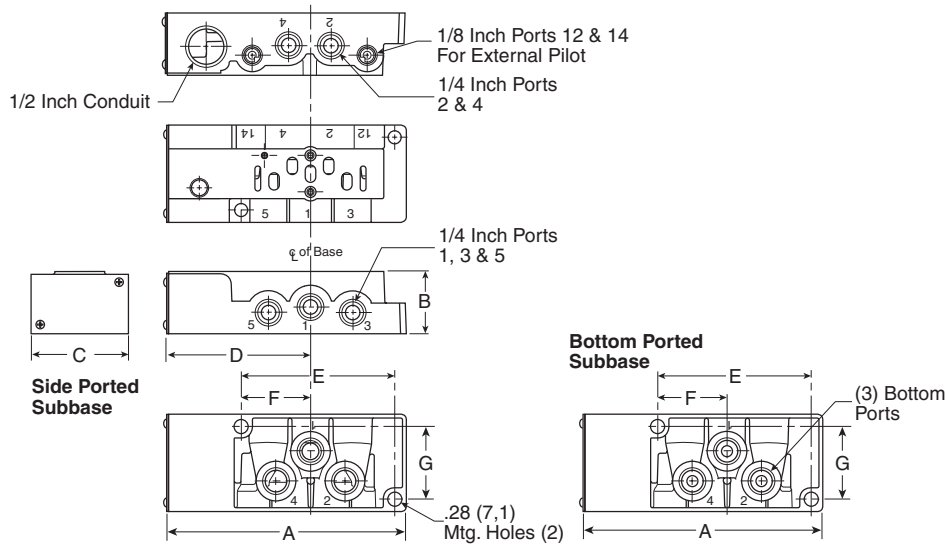

HA Dimensions

A	B	C	D
4.88 (124)	1.28 (32.5)	2.00 (50.8)	2.91 (74)
E	F	G	
1.43 (36.2)	3.16 (80.2)	1.49 (37.9)	

Inches (mm)

Dimensional Data

H Series ISO 5599-1 Size H1, PS4011 Subbase

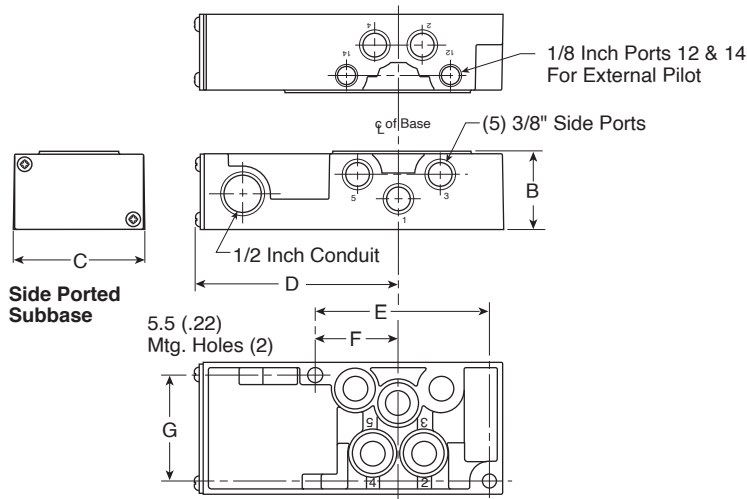

PS4011 Subbase Dimensions

A	B	C	D
5.83 (148)	1.48 (38)	2.50 (64)	3.86 (98)
E	F	G	
3.29 (84)	1.57 (40)	2.00 (51)	

Inches (mm)

H Series ISO 5599-1 Size H2, PS4111 Subbase

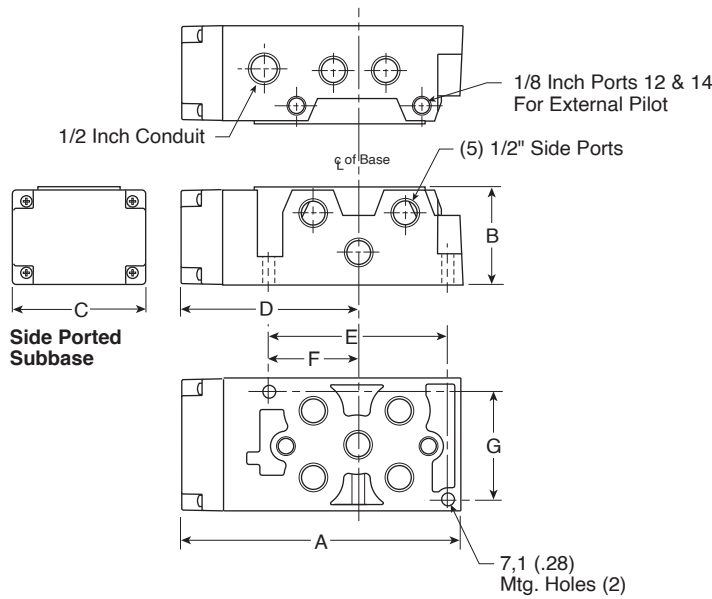

PS4111 Subbase Dimensions

A	B	C	D
6.69 (170)	2.33 (59)	3.15 (80)	4.25 (108)
E	F	G	
4.21 (107)	2.07 (52)	2.56 (65)	

Inches (mm)

D
Subbase & Manual Valves
H Series Micro
Modulflex Series
H Series ISO
Network Connectivity
DX ISOMAX Series
Valvair II Series



For inventory, lead times, and kit lookup, visit www.pdnplu.com

H Series ISO 5599-1 Size H3, PS4211 Subbase

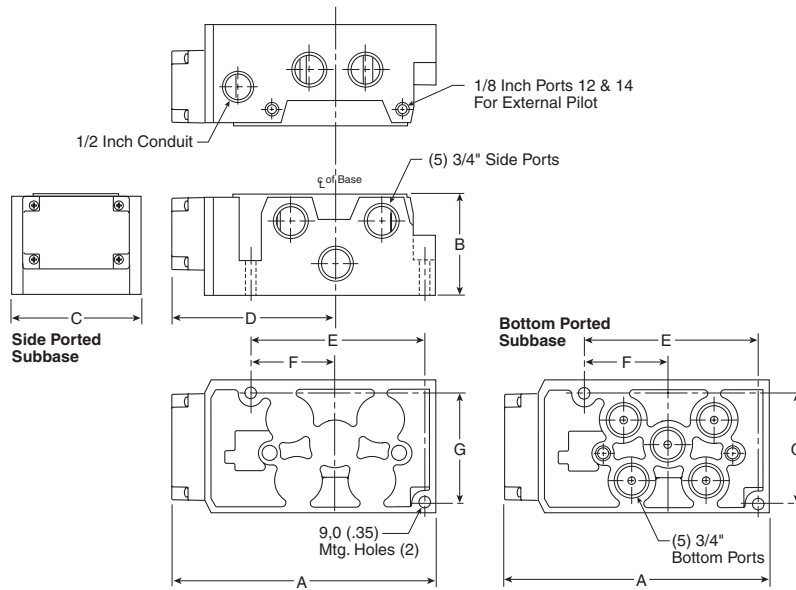

PS4211 Subbase Dimensions

A	B	C	D
7.90 (201)	2.96 (75)	3.90 (99)	4.92 (125)
E	F	G	
5.14 (131)	2.50 (64)	3.24 (82)	

Inches (mm)

H Series ISO 5599 Size H3, PS4211 Manifold

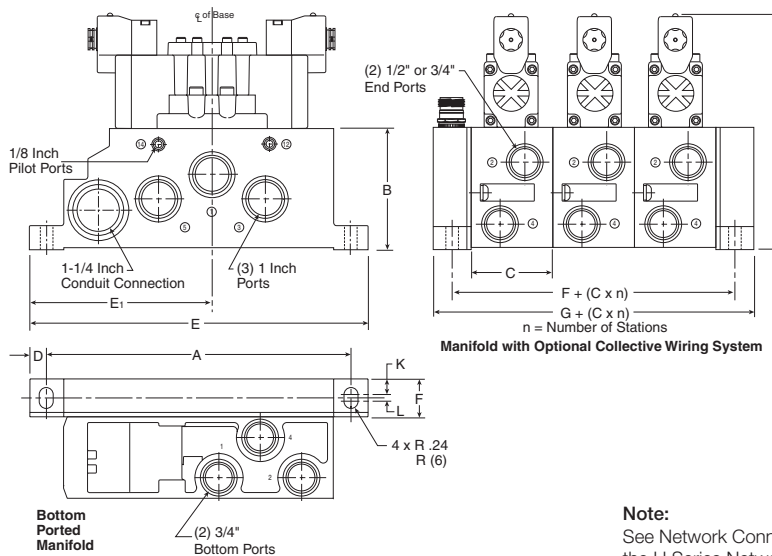

PS4211 Manifold Dimensions

A	B	C	D	E
10.41 (265)	4.13 (105)	2.80 (71)	.59 (15)	11.61 (295)
E ₁	F	G	H	
6.26 (159)	1.30 (33)	2.60 (63)	8.19 (208)	
K	L			
.53 (13.5)	.24 (6)			

Inches (mm)

Note:
 See Network Connectivity Section for the dimensions of manifolds utilizing the H Series Network, Turck Network, or P2M Network Node end plate type.

H Series ISO Universal Manifold

Network Connectivity dimensions (P2H, Turck, H Net, and P2M) are located at the end of the Network Connectivity Section.

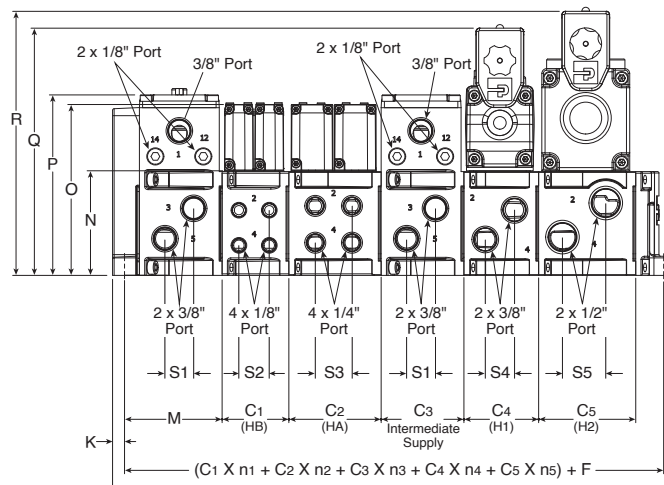
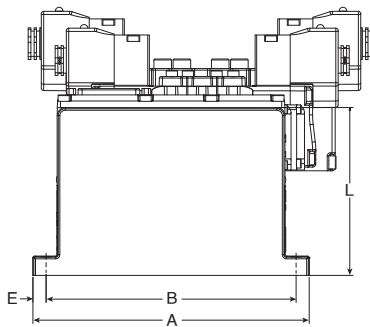
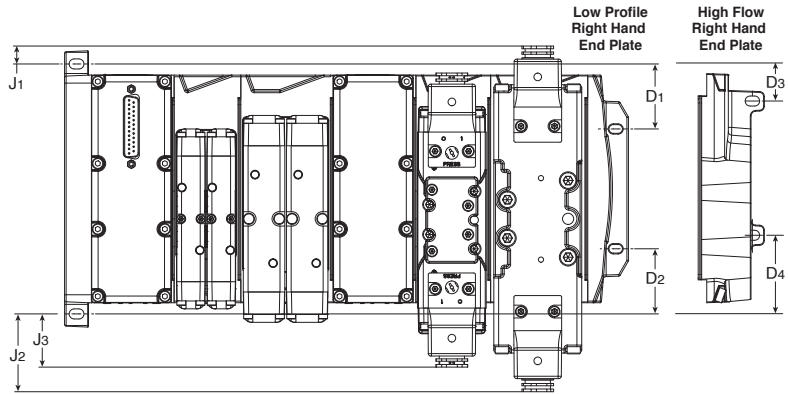

A	B	C1	C2	C3	C4	C5
6.81 (172.95)	6.16 (156.5)	1.65 (41.79)	2.28 (57.79)	2.04 (51.79)	1.84 (46.79)	2.39 (60.79)
D1	D2	D3	D4	E	F	G
1.60 (40.71)	1.60 (40.71)	0.96 (24.3)	1.92 (48.8)	0.32 (8.0)	3.09 (78.58)	4.39 (111.58)
J1	J2	J3	K	L	M	N
0.44 (11.2)	1.92 (48.7)	1.31 (33.3)	0.30 (7.5)	4.14 (105.08)	2.40 (61.08)	1.92 (48.7)
O	P	Q	R	S1	S2	S3
4.21 (107)	4.45 (113)	6.09 (154.77)	6.51 (165.32)	0.71 (18)	0.75 (19)	0.91 (23)
S4	S5					
0.72 (18.3)	1.07 (27.1)					

Inches (mm)

D

Subbase & Manual Valves

H Series Micro

Modulflex Series

H Series ISO

Network Connectivity

DX ISOMAX Series

Valvair II Series



For inventory, lead times, and kit lookup, visit www.pdnplu.com

D144

Parker Hannifin Corporation
 Pneumatic Division
 Richland, Michigan
www.parker.com/pneumatics

H Series ISO Universal Manifold with H3 Transition

Network Connectivity dimensions (P2H, Turck, H Net, and P2M) are located at the end of the Network Connectivity Section.

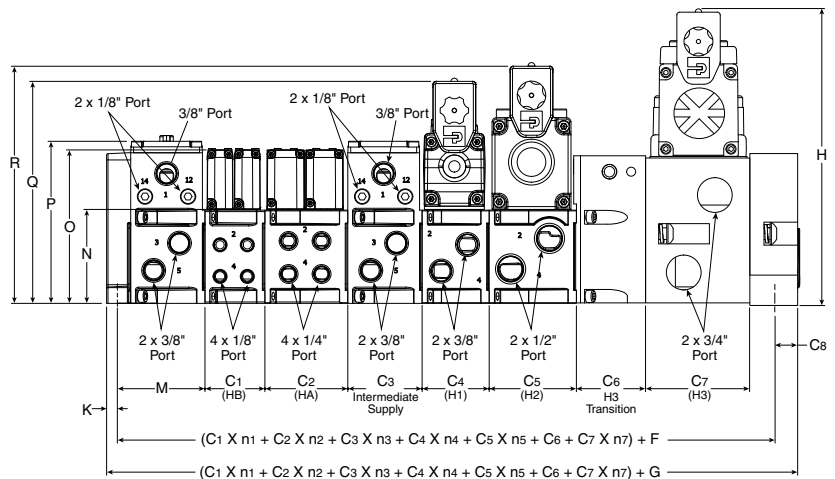
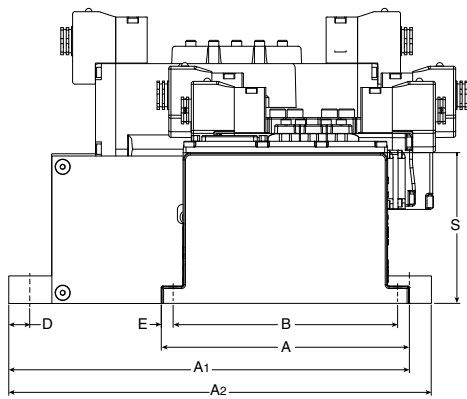
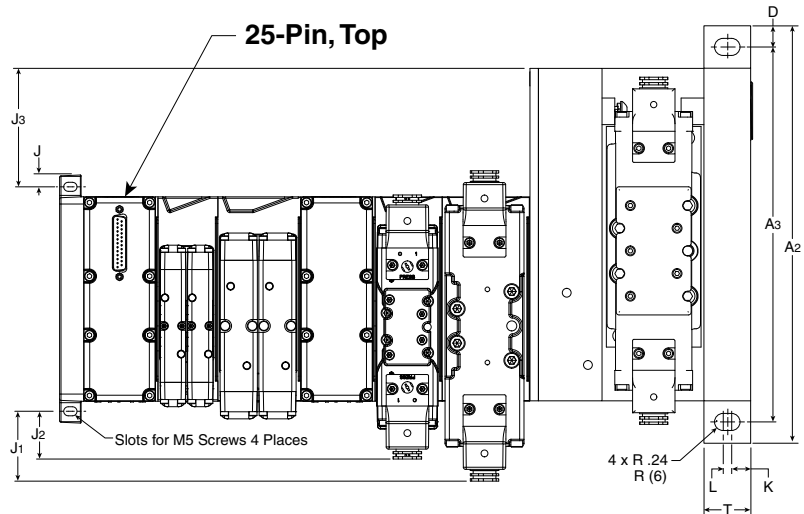
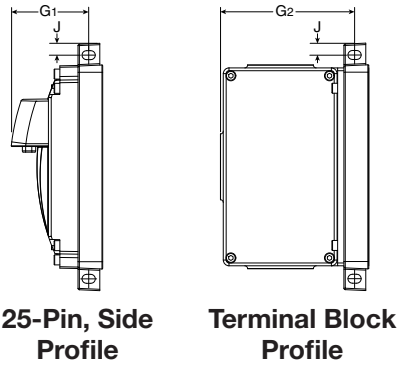

A 6.81 (172.95)	A1 12.34 (313.43)	A2 14.0 (365.3)	A3 10.41 (265)	B 6.16 (156.5)	C1 1.65 (41.79)	C2 2.28 (57.79)	C3 2.04 (51.79)	C4 1.84 (46.79)	C5 2.39 (60.79)	C6 2.00 (51.0)	C7 2.80 (71.0)
C8 0.95 (16.5)	D 0.59 (15.0)	E 0.32 (8.0)	F 3.05 (77.58)	G 4.00 (101.6)	G1 2.13 (54.0)	G2 3.69 (93.8)	H 8.19 (208)	J 0.33 (8.3)	J1 1.92 (48.7)	J2 1.31 (33.3)	J3 3.47 (88.25)
K 0.30 (7.5)	L 0.24 (6.0)	M 2.40 (61.08)	N 1.92 (48.7)	O 4.21 (107)	P 4.45 (113)	Q 6.09 (154.77)	R 6.51 (165.32)	S 4.14 (105.08)	T 1.30 (33.0)		

Inches (mm)

D
Subbase & Manual Valves
H Series Micro
Modulflex Series
H Series ISO
Network Connectivity
DX ISOMAX Series
Valvair II Series



For inventory, lead times, and kit lookup, visit www.pdnplu.com

D145

Parker Hannifin Corporation
 Pneumatic Division
 Richland, Michigan
www.parker.com/pneumatics

25-Pin Side with H Series ISO Valves

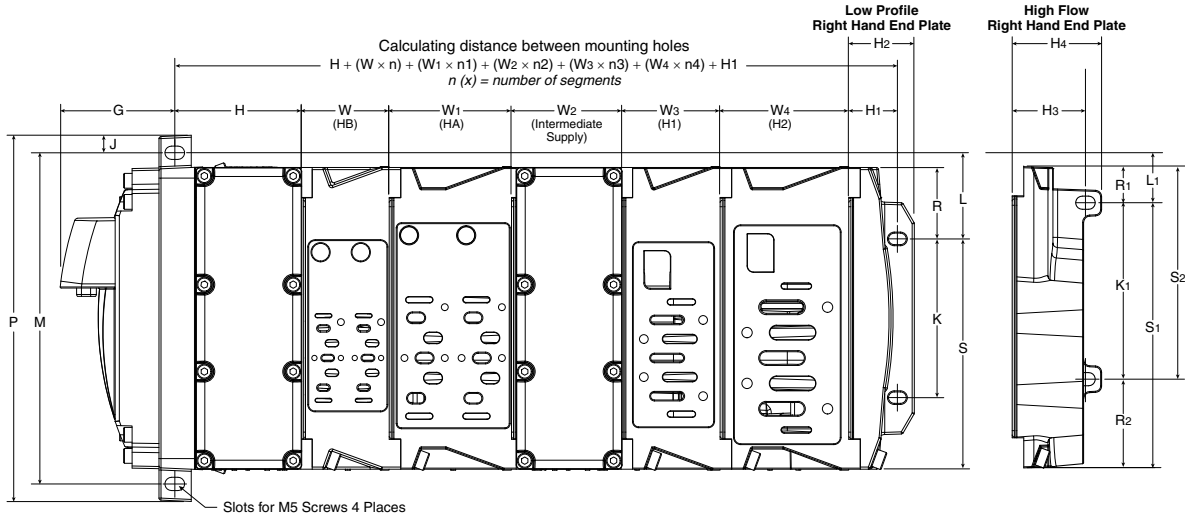

n (x) = number of segments

G	H	H1	H2	H3	H4	J	K	K1	L	L1	M
2.13 (54.0)	2.36 (60.0)	0.90 (23.0)	1.22 (31.0)	1.36 (34.6)	1.66 (42.3)	0.33 (8.3)	2.95 (75.0)	3.28 (83.4)	1.60 (40.7)	0.96 (24.3)	6.16 (156.5)
P	S	S1	S2	R	R1	R2	W	W1	W2	W3	W4
6.81 (173.1)	4.28 (108.8)	4.93 (125.2)	3.96 (100.7)	1.33 (33.7)	0.68 (17.3)	1.6 (41.8)	1.63 (41.3)	2.28 (57.8)	2.06 (52.3)	1.82 (46.3)	2.39 (60.8)

Inches (mm)

Hi-Flow Right Hand End Plate

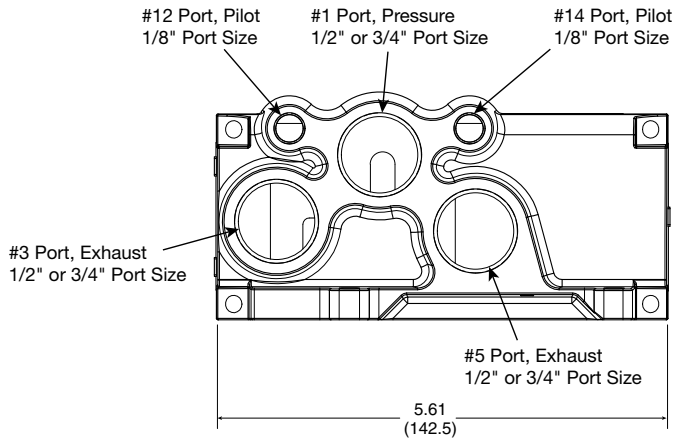

Hi-Flow Right Hand End Plate

PSHU41 1/2" port size

PSHU42 3/4" port size

Inches (mm)



For inventory, lead times, and kit lookup, visit www.pdnplu.com

D146

Parker Hannifin Corporation
 Pneumatic Division
 Richland, Michigan
www.parker.com/pneumatics

D
 Subbase & Manual Valves
 H Series Micro
 Modflex Series
 H Series ISO
 Network Connectivity
 DX ISOMAX Series
 Valvair II Series

Terminal Block with H Series ISO Valves

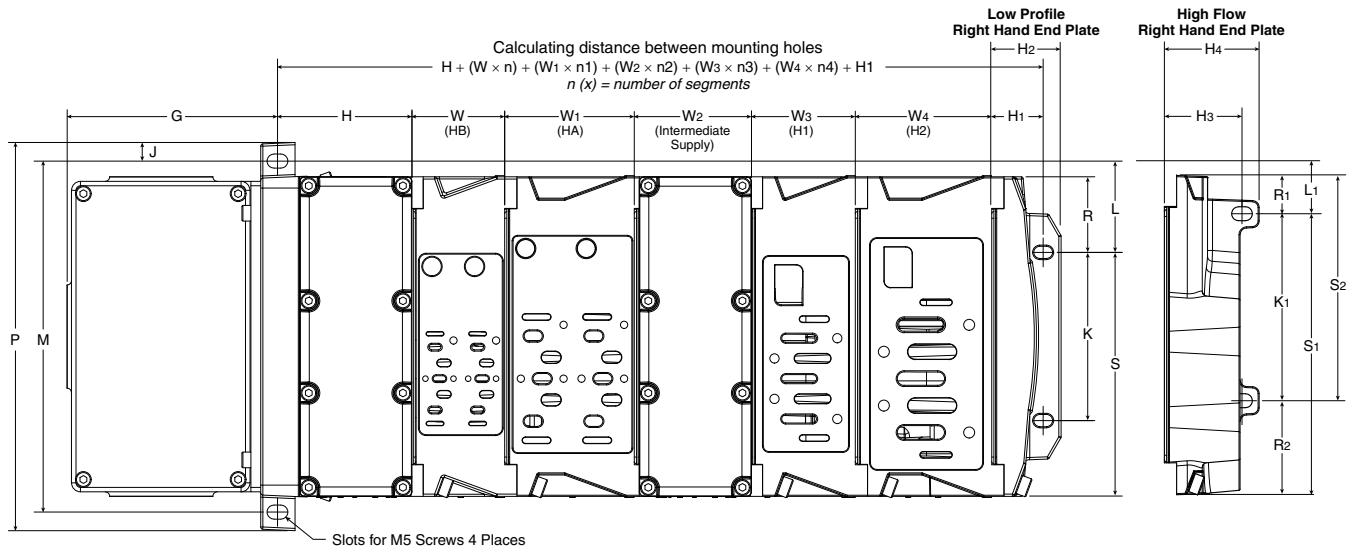

$n(x) = \text{number of segments}$

G	H	H1	H2	H3	H4	J	K	K1	L	L1	M
3.69 (93.8)	2.36 (60.0)	0.90 (23.0)	1.22 (31.0)	1.36 (34.6)	1.66 (42.3)	0.33 (8.3)	2.95 (75.0)	3.28 (83.4)	1.60 (40.7)	0.96 (24.3)	6.16 (156.5)
P	S	S1	S2	R	R1	R2	W	W1	W2	W3	W4
6.81 (173.1)	4.28 (108.8)	4.93 (125.2)	3.96 (100.7)	1.33 (33.7)	0.68 (17.3)	1.65 (41.8)	1.63 (41.3)	2.28 (57.8)	2.06 (52.3)	1.82 (46.3)	2.39 (60.8)

Inches (mm)

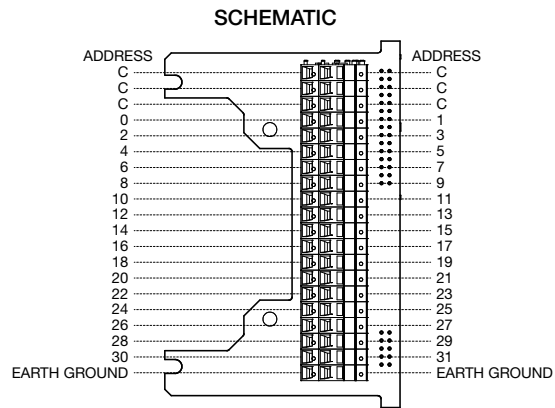
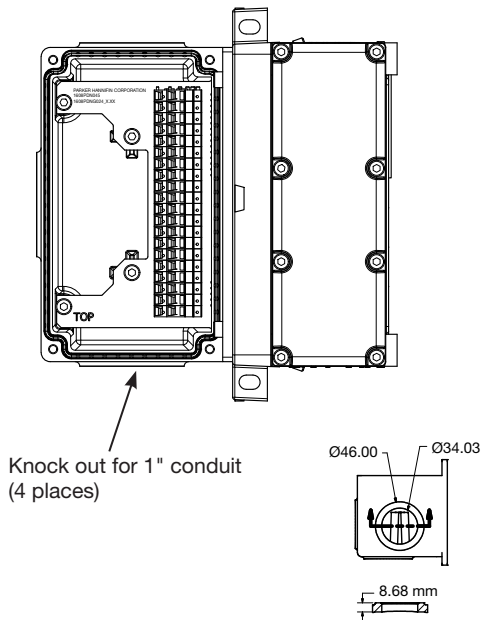

All commons internally
 connected on terminal strip

H Series ISO 15407, HB / HA Sandwich Regulator

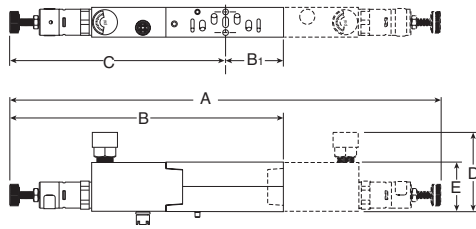

HB / HA Series Sandwich Regulator, Dimensions

	A	B	B ₁	C	D	E
HB (PS5637)	10.28 (261)	6.14 (156)	1.02 (26)	5.13 (130)	2.60 (66)	1.18 (30)
HA (PS5537)	10.00 (254)	6.42 (163)	1.42 (36)	5.00 (127)	2.72 (69)	1.18 (30)

Inches (mm)

H Series ISO 5599, Size H1 Sandwich Regulator

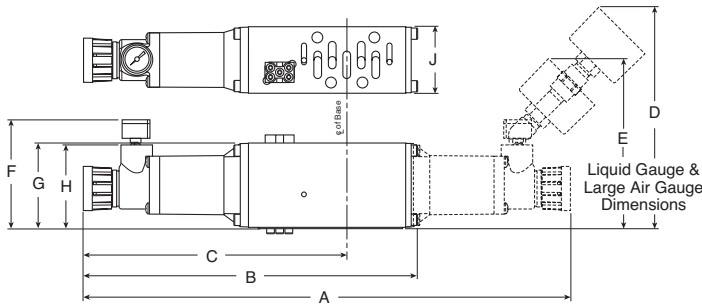

H1 Series Sandwich Regulator, Dimensions

	A	B	C	D	E	F
H1 (PS4037)	11.84 (301)	8.13 (207)	6.40 (163)	5.45 (138)	4.25 (108)	2.85 (72)
(PS4038)	G	H	J			
	2.09 (53)	2.05 (52)	1.63 (41)			

Inches (mm)

H Series ISO 5599, Size H2 & H3 Sandwich Regulator

H2 Sandwich Regulator shown

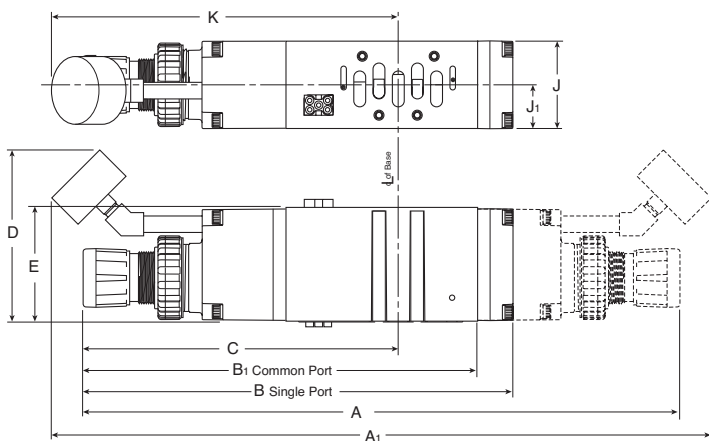

H2 & H3 Series Sandwich Regulator, Dimensions

	A	A ₁	B	B ₁	C	D
H2 (PS4137)	14.65 (372)	16.18 (411)	10.56 (268)	9.84 (250)	7.71 (196)	4.20 (107)
(PS4138)	E	J	J₁	K		
	2.80 (71)	2.15 (55)	1.07 (27)	8.50 (216)		
H3 (PS4237)	A	A₁	B	B₁	C	D
(PS4238)	15.67 (398)	17.15 (436)	11.53 (293)	10.67 (271)	8.37 (213)	4.20 (107)
	E	J	J₁	K		
	2.93 (75)	2.50 (64)	1.25 (32)	9.10 (231)		

Inches (mm)

D
 Subbase & Manual Valves
 H Series Micro
 Modflex Series
 H Series ISO
 Network Connectivity
 DX ISOMAX Series
 Valvair II Series



For inventory, lead times, and kit lookup, visit www.pdnplu.com

H Series ISO 15407, Size 18mm (HB) & 26mm (HA), Flow Control

HA Flow Control

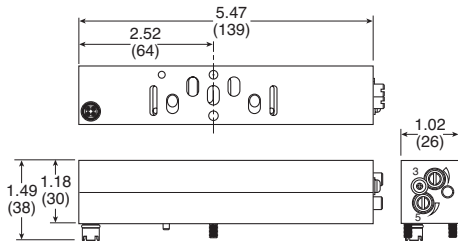

HB Flow Control

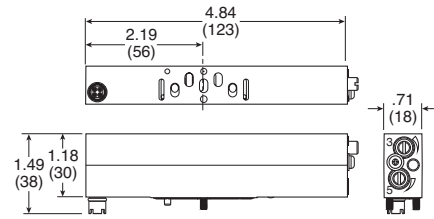

H Series ISO 5599, Size H1, H2 & H3, Flow Control

H1 Flow Control

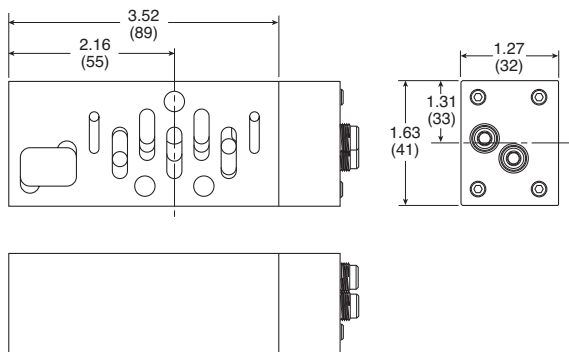

H2 Flow Control

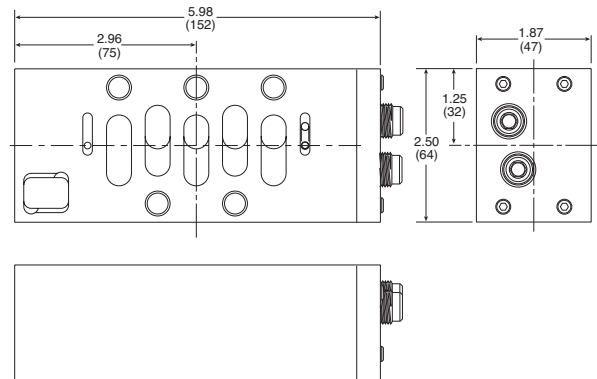

H3 Flow Control

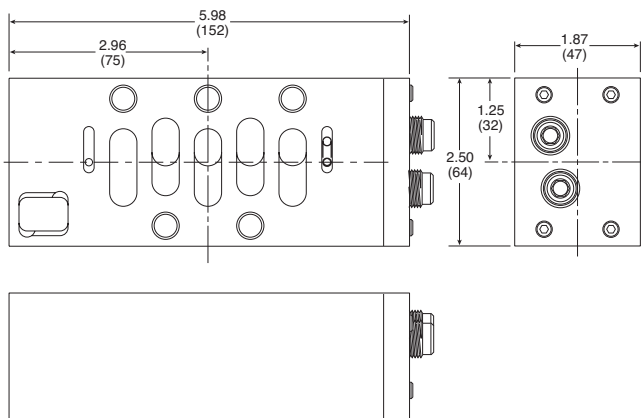

D

Subbase & Manual Valves

H Series Micro

Moduflex Series

H Series ISO

Network Connectivity

DX ISOMAX Series

Valvair II Series



For inventory, lead times, and kit lookup, visit www.pdnplu.com

D149

Parker Hannifin Corporation
 Pneumatic Division
 Richland, Michigan
www.parker.com/pneumatics

D

Subbase & Manual
Valves

H Series
Micro

Modulflex
Series

H Series
ISO

Network
Connectivity

DXISOMAX
Series

Valvair II
Series



For inventory, lead times, and kit
lookup, visit www.pdnplu.com

D150

Parker Hannifin Corporation
Pneumatic Division
Richland, Michigan
www.parker.com/pneumatics

Features

Network Connectivity

Offering

Valve series	P2M	P2H IO-Link	P2H Ethernet	PCH	Turck BL67
Moduflex	X				
H Series Micro	X				X
H Series ISO		X	X	X	X

Protocol	P2M	P2H IO-Link	P2H Ethernet	PCH	Turck BL67
IO-Link	X	X		X	
DeviceNet					X
EtherNet/IP™	X		X	X	X
PROFIBUS-DP					X
PROFINET	X		X	X	X
Modbus/TCP	X		X	X	X
EtherCAT	X		X	X	
PowerLink	X		X		
CANopen					X

Options	P2M	P2H IO-Link	P2H Ethernet	PCH	Turck BL67
24 Solenoid control	X*	X			X
32 Solenoid control			X	X	X
Digital inputs / outputs				X	X
Analog inputs / outputs					X
Class A IO-Link master module				X	X
Class B IO-Link Master module				X	
Short circuit protection on inputs				X	X
Current sensing outputs				X	X
DeviceNet subnet					X
Power over DeviceNet / CANopen					X
CANopen expansion					X

* Only 19 usable when used with Moduflex Valve

P2M Network Nodes (shown on H Micro & Moduflex)



Moduflex

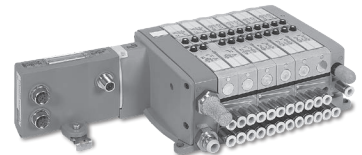

H Micro

P2H Network Node: IO-Link (shown on H Series ISO)

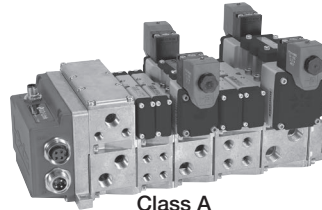

Class A

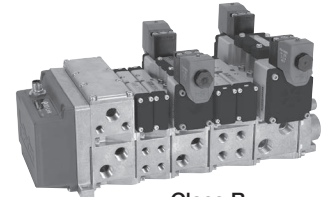

Class B

P2H Network Node: Industrial Ethernet (shown on H Series ISO)

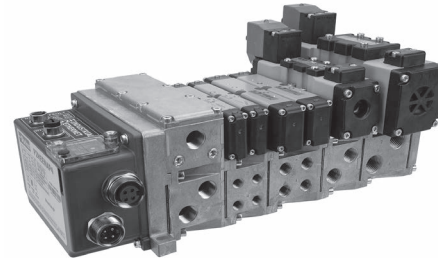

PCH Network Portal (shown on H Series ISO)

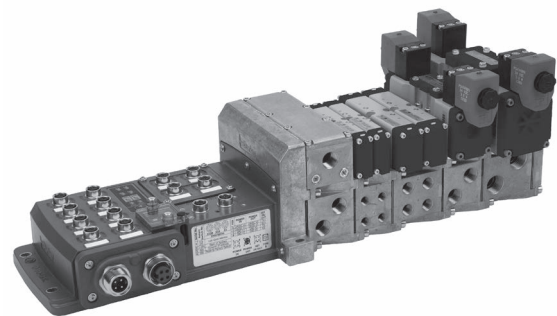

Turck Network Portal (shown on H Series ISO)

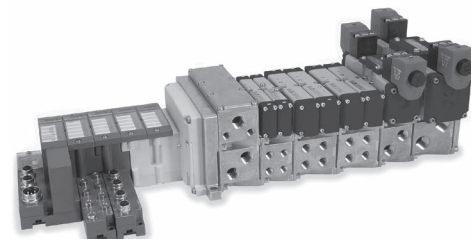

D

Subbase & Manual Valves

H Series Micro

Moduflex Series

H Series ISO

Network Connectivity

DX ISOMAX Series

Valvair II Series



For inventory, lead times, and kit lookup, visit www.pdnplu.com

Industrial Ethernet

Parker's extensive Network Connectivity portfolio can help lower cost of I/O in any control architecture.

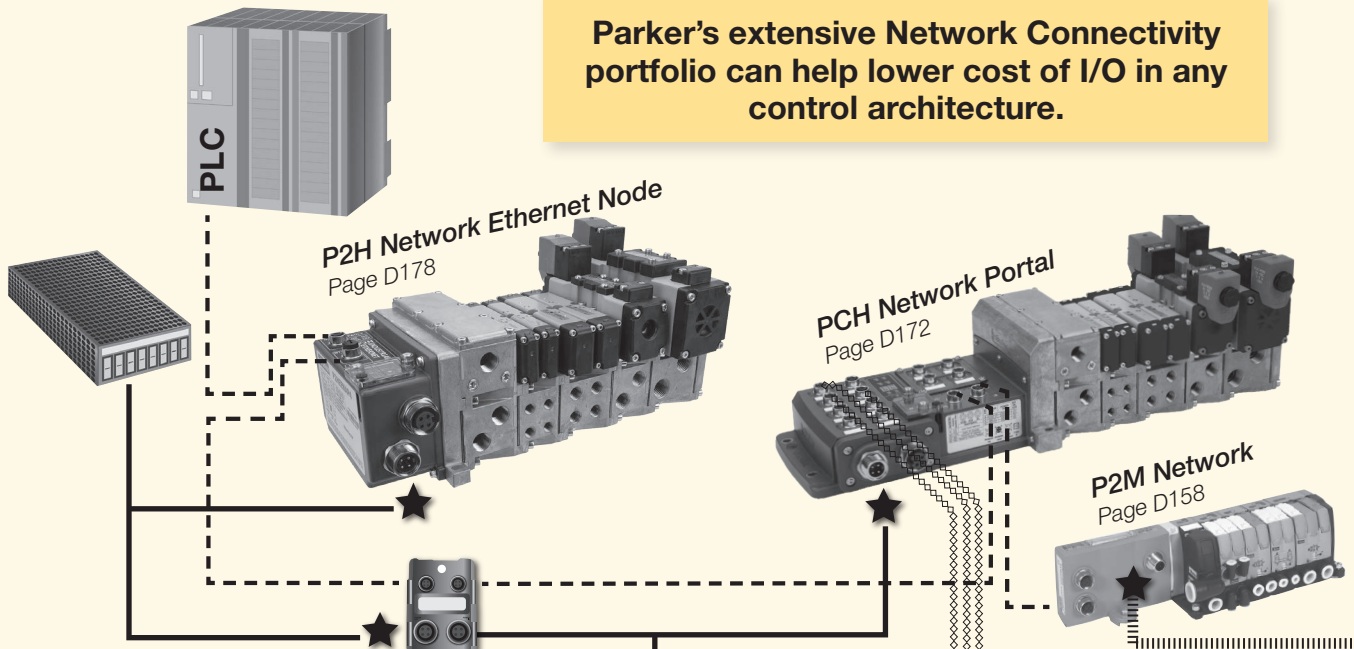

IO-Link

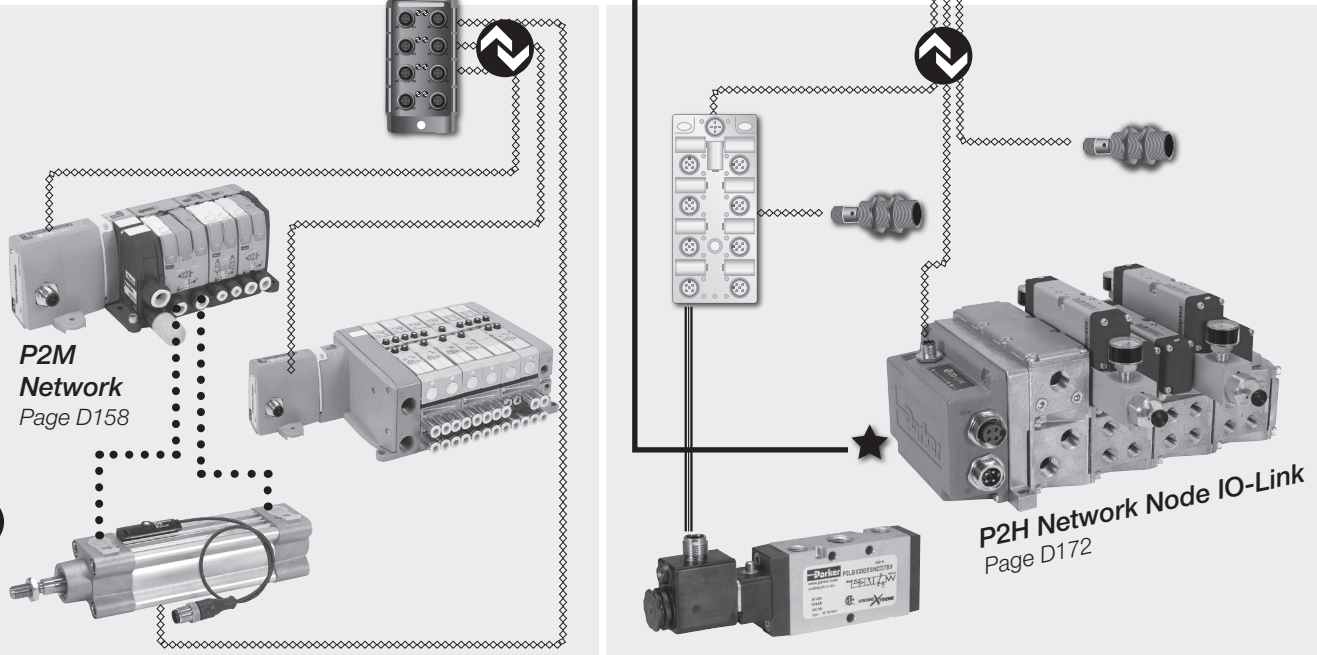

Network to Remote IO-Link Master
 Reduce cabinet size by using a de-centralized "on-machine" IO-Link Master

- * Control all local I/O with IO-Link Masters
 - Discrete I/O
 - "Smart" I/O
 - P2M IO-Link Class B & CPS pictured
[see www.parker.com/pdn/CPS](http://www.parker.com/pdn/CPS)
 and www.parker.com/pdn/P2M_IOL

Node Expansion Using IO-Link

- Reduce node count by adding an IO-Link Master module onto Turck Network manifold
- * 20m max length for I/O-Link cables
- * Control all "smart I/O" on 1 node
- * Reduce cost of secondary valve manifold
 - P2H IO-Link Class A pictured
 see www.parker.com/pdn/P2H_IOL

D

Subbase & Manual
 Valves

H Series
 Micro

Modulflex
 Series

H Series
 ISO

Network
 Connectivity

DX ISOMAX
 Series

Valvair II
 Series



For inventory, lead times, and kit lookup, visit www.pdnplu.com

Features

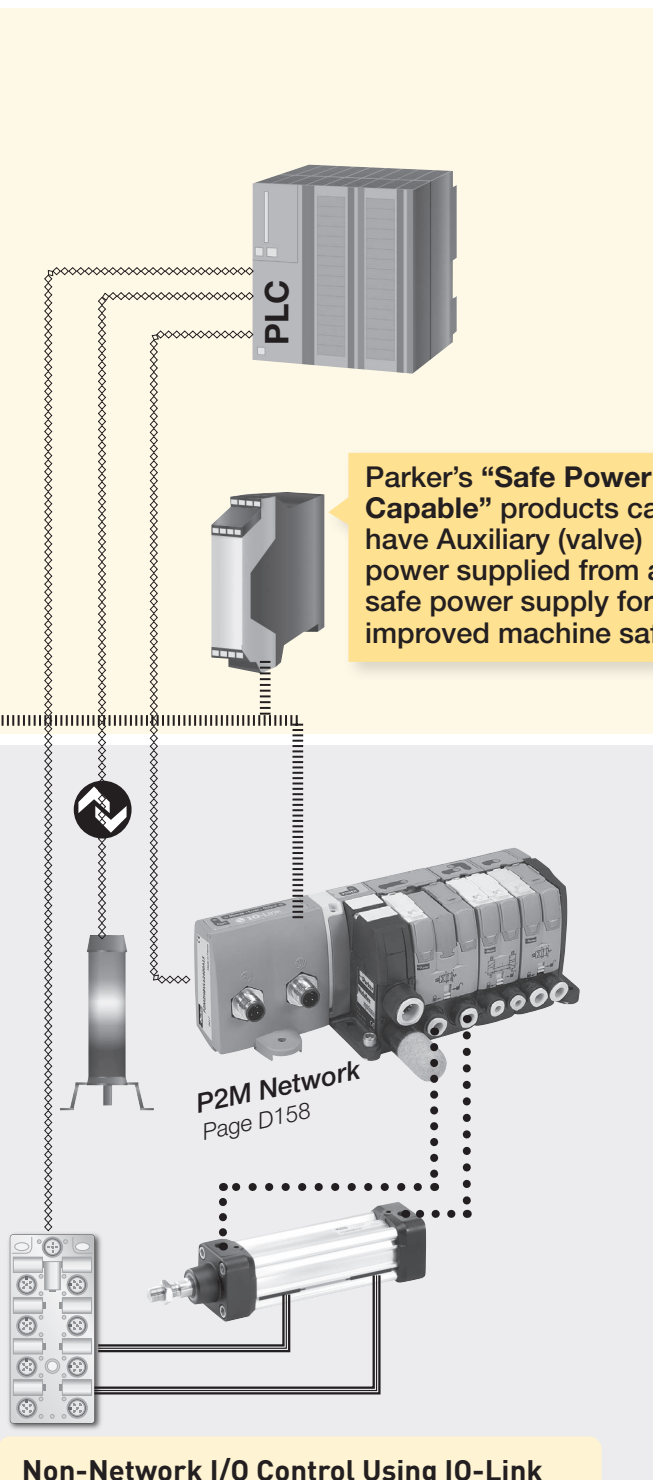

- - - - Industrial Network
 IO-Link 
 = = = = Discrete Wired Input / Output
 — ★ 24 VDC Power
 ||||| ★ 24 VDC SAFE Power
 ••••• Pneumatic

Parker's "Safe Power Capable" products can have Auxiliary (valve) power supplied from a safe power supply for improved machine safety.

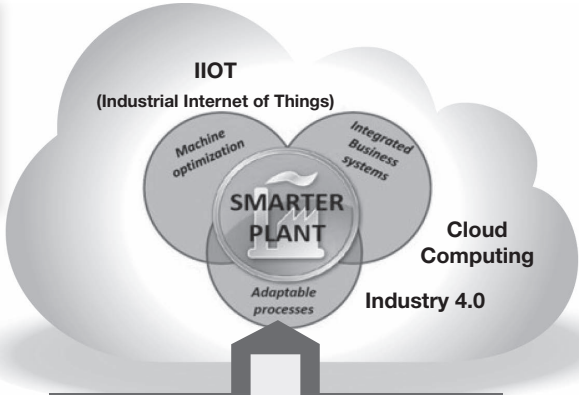

IO-Link is another step towards the smarter plant by lowering the cost for gathering component level prognostics and diagnostics.

Out of Tolerance Warnings

- * Voltage
- * Temperature

Error Descriptors

- * Solenoid short circuit
- * IO-Link communication error cycle count for each valve

Non-Network I/O Control Using IO-Link
 Use PLC with integrated IO-Link Master for machines with smaller I/O counts

- * 20m max length for I/O-Link cables
- * Control all local I/O with IO-Link
 - Discrete I/O
 - "Smart" I/O
 - P2M IO-Link Class A pictured

THIS IS EASIER → Faster installation than discrete wiring
 Standard IP67 M12 cable

THIS IS SAVINGS → Fewer network nodes
 Easy expandability

THIS IS VALUE → Easy access diagnostics
 Prognostics to prevent downtime

D	Subbase & Manual Valves
H Series Micro	
Moduflex Series	
H Series ISO	
Network Connectivity	
DX ISOMAX Series	
Valvair II Series	



For inventory, lead times, and kit lookup, visit www.pdnplu.com

System Overview - Discrete Wiring

- Up to 24 solenoids per manifold (19 when used with Moduflex Valve)
- Discretely wired solenoids - optimized for PLCs with onboard inputs and outputs
- 25-Pin D-Sub, 19-Pin Brad Harrison or M23, or 12-Pin M23 connectors available

Centralized Application

Valves Inside Control Cabinet

- Valves located near machine control
- Applications with caustic wash down, hazardous areas, or extreme temperatures

Disadvantages

- Difficult to troubleshoot
- Difficult to maintain
- Expensive bulkhead fittings
- Long wiring time in cabinet

De-centralized Application

Valves Outside Control Cabinet

- Valves located near application - ready for machine mounting
- IP65 rating suitable for dusty and wet environments

Disadvantages

- Difficult to troubleshoot
- Difficult to maintain
- Long wiring time in cabinet
- Long wiring time in junction box

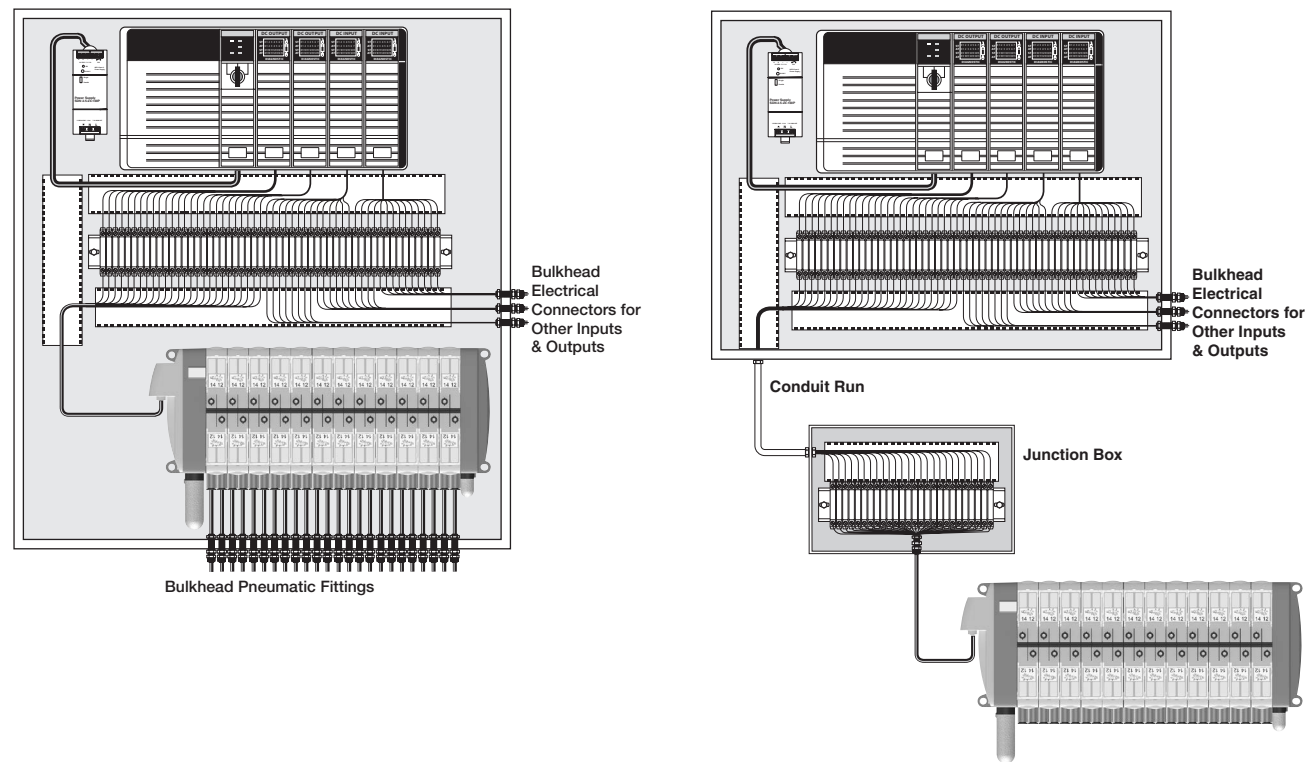

D	Subbase & Manual Valves
H Series Micro	
Moduflex Series	
H Series ISO	
Network Connectivity	
DX ISOMAX Series	
Valvair II Series	



For inventory, lead times, and kit lookup, visit www.pdnplu.com

Introduction to Control Systems

System Overview - P2M Network Node

- Up to 24 solenoids per manifold (19 when used with Moduflex Valve)
- Optimized for PLCs with network capability
- Routinely used on medium sized machines
- Connectivity to Moduflex, H Series Micro and H Series ISO valves

Centralized Application

Valves Inside Control Cabinet

- Valves located near machine control
- Applications with caustic wash down, hazardous areas, or extreme temperatures
- Additional inputs and outputs are not directly attached to valve manifold

Advantages

- Highest degree of environmental protection
- One location for all control devices
- Small size requires minimal cabinet space
- Eliminates terminal strips and wire ways for valves
- Greatly reduces wiring time
- Eliminates junction boxes for valves
- Eliminates conduit runs for valves

De-centralized Application

H Series Micro Outside Control Cabinet

- Valves located near application - ready for machine mounting
- IP65 rating suitable for dusty and wet environments
- Additional inputs and outputs are not directly attached to valve manifold

Advantages

- Smallest control cabinet
- Reduces tubing length and improves pneumatic response time
- Eliminates pneumatic bulk fittings on control cabinet
- Many network nodes can be attached to the network with little incremental cost – valve manifolds, inputs, outputs and other devices
- Eliminates terminal strips and wire ways for valves
- Greatly reduces wiring time
- Eliminates junction boxes for valves
- Eliminates conduit runs for valves

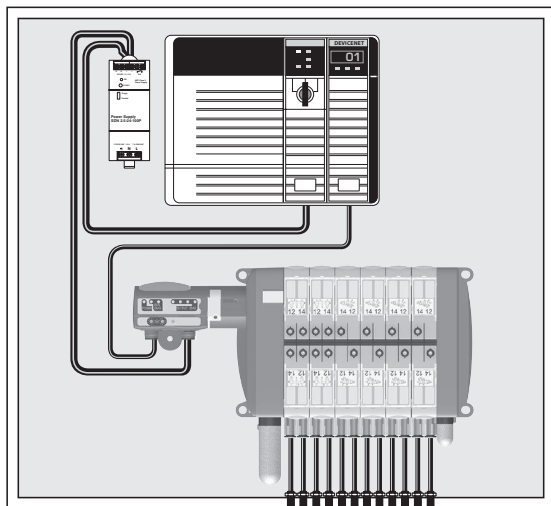

Bulkhead Pneumatic Fittings

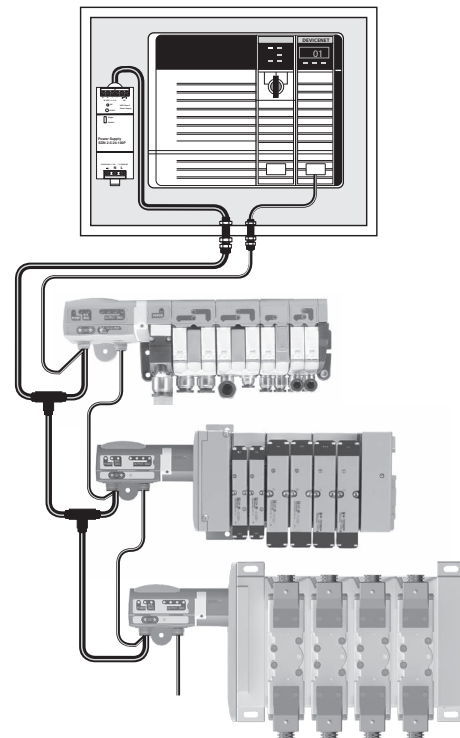

For inventory, lead times, and kit lookup, visit www.pdnplu.com

System Overview - Turck Network Portal with CANopen Expansion

General Product Features

- Turck Network Portal with up to 256 inputs / outputs and up to 16 or 32 solenoids per manifold
- Digital inputs / outputs, IO-Link Class A Master analog inputs / outputs, serial interface, counter modules, and RFID modules available
- Connectivity to H Series Micro and H Series ISO valves

CANopen Expansion Features

- Using a CANopen interface module, a CANopen subnet is created within the Turck Network Portal, controlling an additional 64 inputs, outputs, or solenoids
- The CANopen subnet is independent of the main network, and is not visible to the master PLC
- Additional P2M CANopen modules can be attached to the CANopen subnet to provide a connection for 16 solenoids each
- Other 3rd party CANopen devices can also be used on this network, within the 64 bit CANopen expansion limit

System Advantages

- Handle all I/O from one node; eliminate PLC input / output cards
- Optimized for PLC's with network capability
- Several CANopen nodes can be attached to the network – valve manifolds, inputs, outputs or other devices
- CANopen expansion allows additional devices to be attached to the system without a CANopen scanner card
- Eliminates junction boxes, terminal strips, and conduit runs for all inputs and outputs, greatly reducing wiring time

Centralized Application

Valves Inside Control Cabinet

- Valves located near machine control
- Applications with caustic wash down, hazardous areas, or extreme temperatures

Advantages

- Highest degree of environmental protection
- One location for all control devices
- Small size requires minimal cabinet space

De-centralized Application

Valves Outside Control Cabinet

- Valves located near application - ready for machine mounting
- IP65 rating suitable for dusty and wet environments

Advantages

- Smallest control cabinet
- Reduces tubing length and improves response time
- Eliminates pneumatic bulk fittings on control cabinet

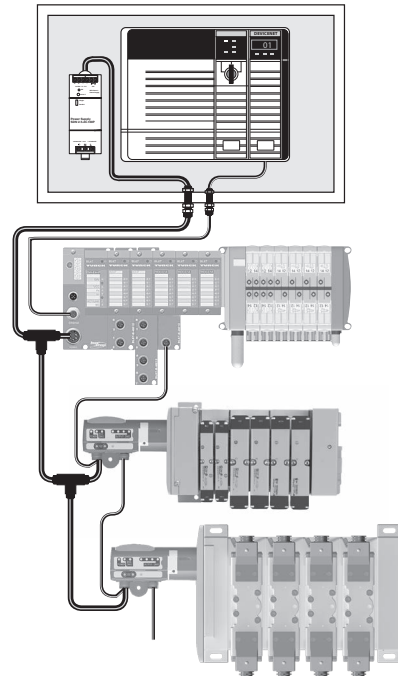
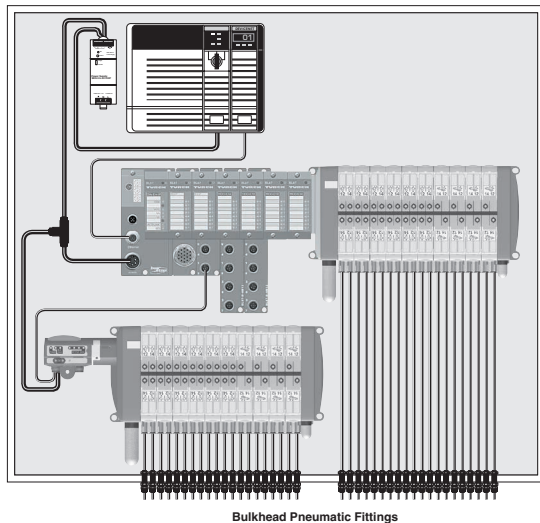
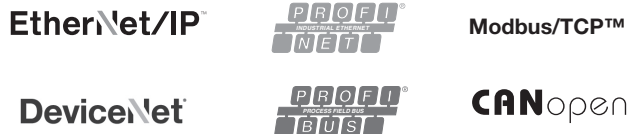

Introduction to Control Systems

System Overview - Turck Network Portal with BL Remote DeviceNet Subnet

General Product Features

- Turck Network Portal with up to 256 inputs / outputs and up to 16 or 32 solenoids per manifold
- Digital inputs / outputs, IO-Link Class A Master analog inputs / outputs, serial interface, counter modules, and RFID modules available
- Connectivity to H Series Micro and H Series ISO valves

BL Remote DeviceNet Subnet Features

- With BL remote DeviceNet subnet functionality, each communication module has its own DeviceNet master which provides a connection for 63 DeviceNet nodes with additional inputs, outputs, and solenoid control
- BL remote DeviceNet subnet is independent of the main network, and is not visible to the master PLC
- P2M DeviceNet modules can be attached to the subnet to provide a connection for 16 solenoids each
- Turck DeviceNet modules can be attached to the subnet to provide a connection for 16 or 32 solenoids each and inputs and outputs up to the 256 input and output limitation

System Advantages

- Handle all I/O from one node; eliminate PLC input / output cards
- Optimized for PLC's with network capability
- Many DeviceNet nodes can be attached to the network – valve manifolds, inputs, outputs or other devices
- Eliminates junction boxes, terminal strips, and conduit runs for all inputs and outputs, greatly reducing wiring time

Centralized Application

Valves Inside Control Cabinet

- Valves located near machine control
- Applications with caustic wash down, hazardous areas or extreme temperatures

Advantages

- Highest degree of environmental protection
- One location for all control devices
- Small size requires minimal cabinet space

De-centralized Application

Valves Outside Control Cabinet

- Valves located near application - ready for machine mounting
- IP65 rating suitable for dusty and wet environments

Advantages

- Smallest control cabinet
- Reduces tubing length and improves response time
- Eliminates pneumatic bulk fittings on control cabinet

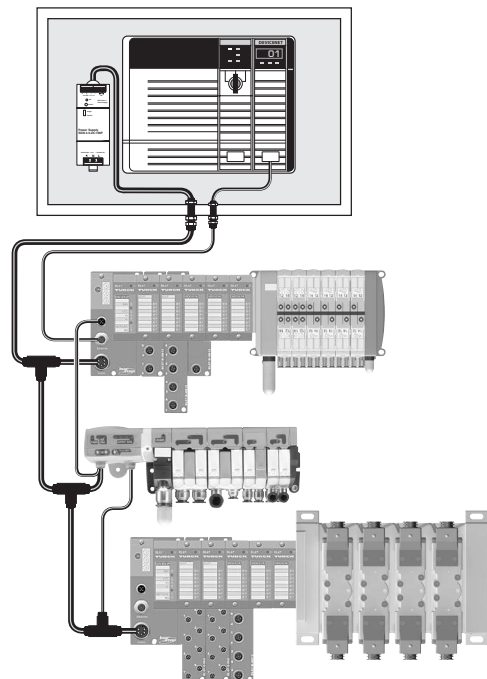
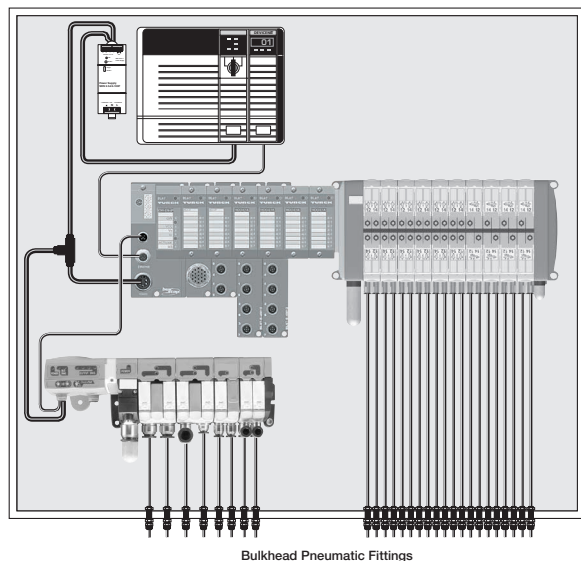

D
 Subbase & Manual Valves
 H Series Micro
 Modulflex Series
 H Series ISO
 Network Connectivity
 DX ISOMAX Series
 Valvair II Series



For inventory, lead times, and kit lookup, visit www.pdnplu.com

Introduction to Control Systems

System Overview - Turck Network Portal with Stand Alone Control using CoDeSys

General Product Features

- Turck Network Portal with up to 256 inputs / outputs and 32 solenoids per manifold
- Digital inputs / outputs, analog inputs / outputs, serial interface, counter modules, and RFID modules available
- Connectivity to H Series Micro and H Series ISO valves

Stand Alone Control Features

- Communication modules equipped with standalone control – programmed according to IEC61131-3 with CoDeSys
- 512KB program memory with 32 bit RISC processor
- Run 1000 instructions in less than 1 ms
- Optimized for PLC’s with network capability or standalone controllers that need to interface with other devices

System Advantages

- Handle all I/O and control with one system; eliminate the PLC when used as the main controller for smaller machines
- Reduces programming and bandwidth requirements on large machines with a master PLC controller by handling local I/O and interfacing with the PLC over the network
- Eliminates junction boxes, terminal strips, and conduit runs for all inputs and outputs, greatly reducing wiring time

Centralized Application Valves

Inside Control Cabinet

- Valves attached to the machine control
- Applications with caustic wash down, hazardous areas, or extreme temperatures

Advantages

- Highest degree of environmental protection
- One location for all control devices

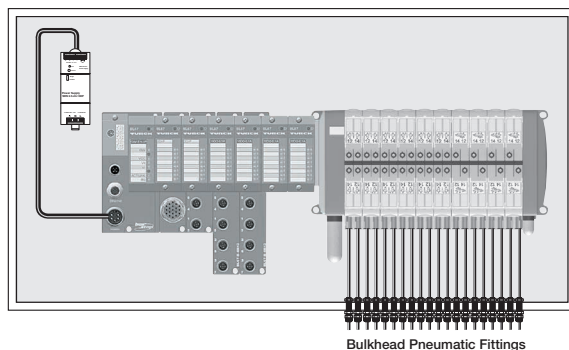

De-centralized Application

Valves Outside Control Cabinet

- Valves and machine control located near application - ready for machine mounting
- IP65 rating suitable for dusty and wet environments

Advantages

- No control cabinet needed when used as the main controller
- Reduces tubing length and improves response time
- Eliminates pneumatic bulk fittings on control cabinet

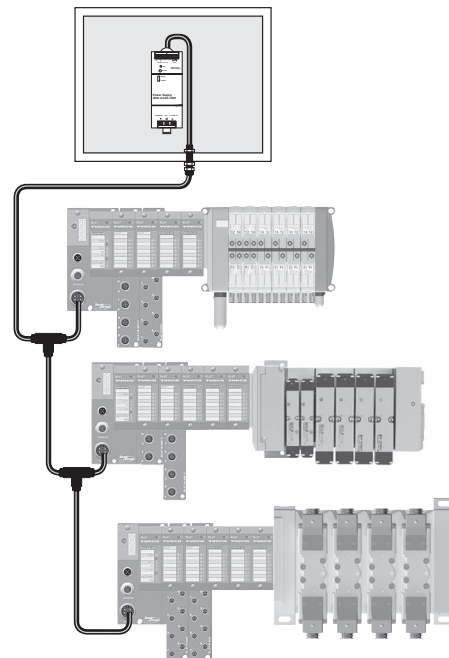

D

Subbase & Manual
Valves

H Series
Micro

Modulflex
Series

H Series
ISO

Network
Connectivity

DXISOMAX
Series

Valvair II
Series



For inventory, lead times, and kit lookup, visit www.pdnplu.com

D160

Parker Hannifin Corporation
Pneumatic Division
Richland, Michigan
www.parker.com/pneumatics

Features

P2M Network Nodes

P2M communication modules directly attach to the Moduflex valve series as well as the P2M endplates of the H Series Micro. It offers a compact and low cost network solution.

Features

- Small, compact product design
- IO-Link Class A & Class B nodes
- Ethernet Communications
 - EtherNet/IP™
 - Profinet
 - EtherCat
 - Powerlink
 - ModbusTCP
- Channel-level diagnostics (LED and Electronic)
- Horizontal and vertical mounting without derating
- 5g vibration
- Quick-disconnects for I/O and network connectivity
- Built-in panel grounding
- CE certification



D

Subbase & Manual Valves

H Series Micro

Moduflex Series

H Series ISO

Network Connectivity

DX ISOMAX Series

Valvair II Series



For inventory, lead times, and kit lookup, visit www.pdnplu.com

D161

Parker Hannifin Corporation
Pneumatic Division
Richland, Michigan
www.parker.com/pneumatics

Features

P2M Network Nodes

P2M communication module attaches directly to the end plate. It offers a compact and low cost network solution.

Features

- Small, compact product design
- IO-Link Class A & Class B nodes
- Broad protocol offering
- Built-in panel grounding
- CE certification

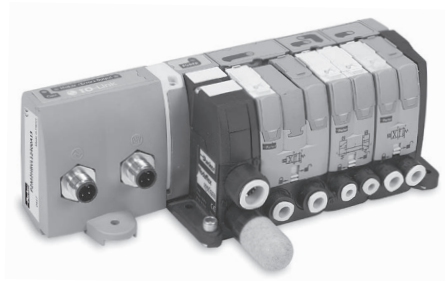

P2M2HBVL12400A13
(Class A IO-Link)

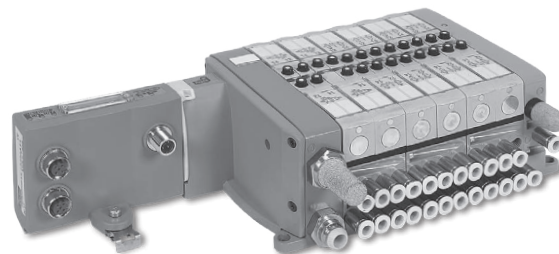

P2M2HBVE12400
(EtherNet/IP™)





D

Subbase & Manual Valves

	Industrial Ethernet Protocol	Maximum Addresses †	Part number
	EtherNet/IP™ (Safe Power Capable)	24 †	P2M2HBVE12400
	PROFINET (Safe Power Capable)	24 †	P2M2HBVN12400
	EtherCAT (Safe Power Capable)	24 †	P2M2HBVT12400
	Modbus/TCP (Safe Power Capable)	24 †	P2M2HBVM12400
	PowerLink (Safe Power Capable)	24 †	P2M2HBVW12400

H Series Micro

	IO-Link class	IO-Link	Aux. power	Aux. power pinout	Maximum addresses †	Part number	
						Standard	Safe power capable *
	Class A	3 Pins	3 Pins	1 & 3	24 †	P2M2HBVL12400A13	P2M2HBVL12400A13-SPC
		3 Pins	3 Pins	4 & 3	24 †	P2M2HBVL12400A43	P2M2HBVL12400A43-SPC
		3 Pins	5 Pins	4 & 2	24 †	P2M2HBVL12400A42	P2M2HBVL12400A42-SPC
	Class B	5 Pins		2 & 5	24 †	P2M2HBVL12400B25	P2M2HBVL12400B25-SPC

* Safe Power Capable (-SPC) version is suitable for connection to an OSSD (test pulsed) SAFE output source.

† If using with Moduflex valves, maximum solenoid addresses limit is 19.

Further details: www.parker.com/pdn/P2M_IOL

 Most popular.

DX ISOMAX Series

Valvair II Series



For inventory, lead times, and kit lookup, visit www.pdnplu.com

P2M Industrial Ethernet Node

The P2M Industrial Ethernet 24 DO node allows a very simple and cost efficient connection to the most popular Industrial Ethernet networks.

Designed with isolated auxiliary power, it can easily be adapted to all power supply architectures and follow any required machine directives as Safe Power Capable.

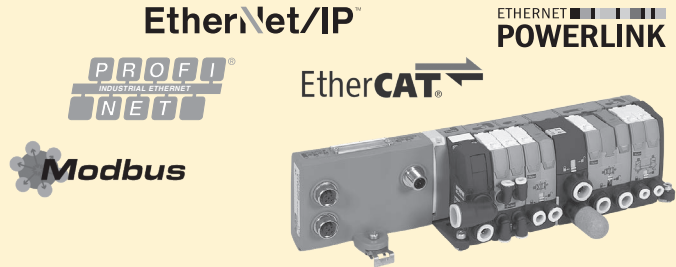

Simple Product Set-Up

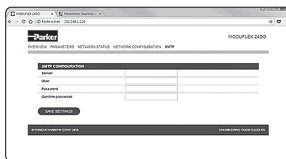

The P2M Industrial Ethernet Node offers IP addressing through 3 rotary switches located on the top side.

The 3 rotary switches also allow for Factory Reset, IP address storage, and DHCP addressing.

If supported by the protocol used, the IP address can be modified through the embedded web page.

For an application requiring a regular disconnection / reconnection of communication & power, PROFINET and EtherNet/IP™ protocols allow respectively a Fast Start-Up (FSU) and Quick Connect mode. This mode can be enabled or disabled.

Topology / Integrated Ethernet Switch

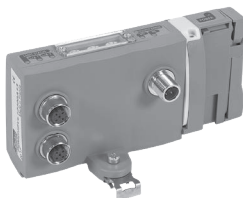

The P2M Industrial Ethernet 24 DO Node offers 2 Ethernet ports allowing a line topology without external switch. The Ring topology can also be supported (enable/disable) for PROFINET, EtherNet/IP™ and Modbus TCP/IP.

The integrated Ethernet switch supports Class C services allowing use in an isochronous real time (IRT) structure.

Easy Diagnostics – Local LEDs, Process (cyclic) data, Parameter (acyclic) data

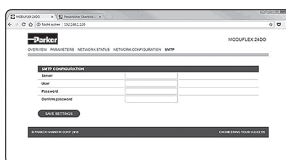

The P2M Industrial Ethernet 24 DO Node offers local diagnostics through 7 LED's located on the visible top side, showing:

- Logic status
- Ethernet activity on both ports
- Standard status due to protocol
- Output error / Auxiliary power

This local information as well as configuration and predictive maintenance diagnostics (Power monitoring, Solenoid cycle counting, etc) are available via both Process Data (cyclic) and Parameter Data (acyclic) via the PLC through the network and also easily viewable from the embedded web page.

When the PLC is NOT in control, the web page allows the user to force ON/OFF the solenoids state. This function has password protection.

Safe Power Capable

Auxiliary power of P2M Industrial Ethernet 24 DO Node can be supplied from a safe output device following machinery directives. This includes:

- Output Signal Switch Device (OSSD) test pulse compatible
- Galvanic isolation between 0 VDC Logic and Auxiliary power
- PP or PM cabling modes

For more details, refer to the user manuals located at www.parker.com/pdn/P2M_IE



For inventory, lead times, and kit lookup, visit www.pdnplu.com

D163

Parker Hannifin Corporation
 Pneumatic Division
 Richland, Michigan
www.parker.com/pneumatics

D

Subbase & Manual Valves

H Series Micro

Modulflex Series

H Series ISO

Network Connectivity

DX ISOMAX Series

Valvair II Series

P2M Industrial Ethernet Connections & Configuration

Ethernet ports and Auxiliary power connection

Ethernet ports: 2 x Standard Female M12 D-Coded – 5 pins
 Auxiliary Power: Standard Male M12 A-Coded – 4 pins

Configuration file

The configuration files (.EDS, .GDS, etc) can be download from the product web page.

Add on Instructions & Function Blocks

Add on Instructions & Function Blocks to assist in the configuration and programming of the P2M Node are available on the product web page – www.parker.com/pdn/P2M_IE

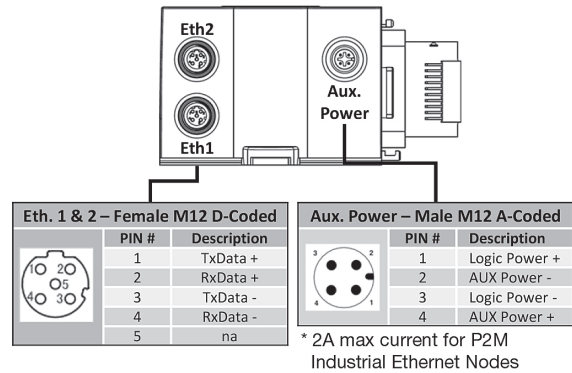

IP Address Setting

Can be done via Rotary Switches, DHCP, Web page, Ipconfig Tool or TCP/IP Interface Object, depending on protocol:

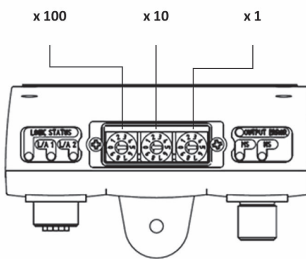

Description	EtherNet/IP™ Profinet IO Modbus TCP/IP	Ethernet PowerLink	EtherCAT
IP-Address setting stored into the NV-memory of the P2M node	000	000	N/A
IP-Address setting determined by the 3 rotary switches:			
• IP Address: 192.168.1.xxx	001 – 254	001 – 239	N/A
• Subnet Mask: 255.255.255.0			
• Default Gateway for 001: 192.168.1.2			
• Default Gateway for 002 - 254: 192.168.1.1			
The device will obtain its address via DHCP	888	N/A	N/A
Reset to factory status	999	999	999
Invalid, the module will not start	All others	All others	All others

P2M Industrial Ethernet Valve Control

All P2M Industrial Ethernet Modules can easily connect to and control pneumatic valves sizes ranging from 0.18 Cv to 6.0 Cv utilizing the Moduflex, H Micro, or H ISO valve series including the new H ISO Universal manifold which can mix ISO sizes 15407 (sizes 02 & 01) and 5599 (sizes 1 & 2) without transition plates.

P2M on Moduflex



P2M on H Series Micro

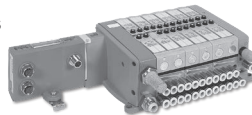

P2M Industrial Ethernet Node Output (Solenoid) data mapping - shown on Moduflex valve series

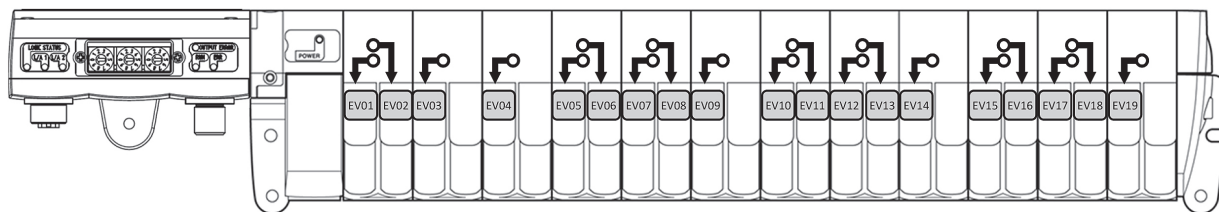

	7 3	2 0
Byte 0	EV08 EV01	
Byte 1	EV16 EV09	
Byte 2*	EV24 EV20	EV19 EV17

* Byte 2 / Bits 3 to 7 are only available when connected to H Series Micro or H Series ISO valve manifolds. The Moduflex valve series is limited to 19.

Process (Cyclic) Diagnostic through network via ADI #9 – “Module Error Input”

Easy to access diagnostic data transmitted to the PLC as Application Device Instance (ADI) #9

- Voltage warning, short circuit condition, module error, etc
- For more details refer to user manual on product web page – www.parker.com/pdn/P2M_IE

ADI	Instance name	Data type	Access
#9	Module error input	Unit 16	Read
Byte 0	Diag 7 Diag 0		
Byte 1	Reserved		



For inventory, lead times, and kit lookup, visit www.pdnplu.com

D
 Subbase & Manual Valves
 H Series Micro
 Moduflex Series
 H Series ISO
 Network Connectivity
 DX ISOMAX Series
 Valvair II Series

Valve Island V Series with Industrial Ethernet connection

EtherNet/IP™

EtherCAT®

The P2M Industrial Ethernet Lite node 24DO allows a very simple and cost efficient connection to the most popular Industrial Ethernet networks.

In its compact IP40 version equipped with two RJ45 Ethernet ports, it saves size in cabinet applications and offers an easy connection to the network in a line topology.

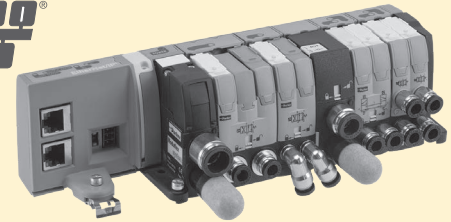

Industrial Ethernet Protocol	Part Number
Profinet IO	P2M2HBVE12400RJ
EtherNet/IP™	P2M2HBVN12400RJ
EtherCAT	P2M2HBVT12400RJ

Product Set-Up

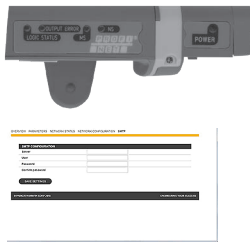

The P2M Lite Node 24DO is by default in DHCP mode. The module must be assigned to a static IP-Address in order to be controlled via the network.

The Network Configuration settings can be done through the embedded web server of the node as well as "IPconfig", "TIA Portal" or similar methods.

For an application requiring a regular disconnection / reconnection of the node, Profinet and EtherNet/IP™ protocols allow respectively a Fast Start-Up (FSU) and Quick Connect mode. This mode can be enable or disable .

Technology / Integrated Ethernet Switch



The P2M Industrial Ethernet Lite node 24DO offers 2 RJ45 ports allowing a line topology without external switch. The Ring topology can also be supported (enable/disable) for Profinet and EtherNet/IP™.

The integrated Ethernet switch support Class C Services allowing used in an isochronous real time (IRT) structure.

Diagnostic

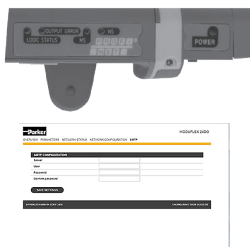

The P2M Industrial Ethernet Lite node 24DO offers a local diagnostic through 5 LED's located on the visible top side and 4 additional on both Ethernet connectors showing:

- Logic status
- Ethernet activity on both ports
- Standard Status due to protocol
- Output error / Power Supply

This local information as well as trouble shooting and predictive maintenance diagnostics (Power monitoring, Life cycle counting, ...) are available in PLC through the network and reported on imbedded web page.

When PLC is in "STOP", the web page allows to force ON/OFF solenoids state. This function has a password protection.

Save 1.31 inches with P2M Lite Node compared to P2M Ethernet Node

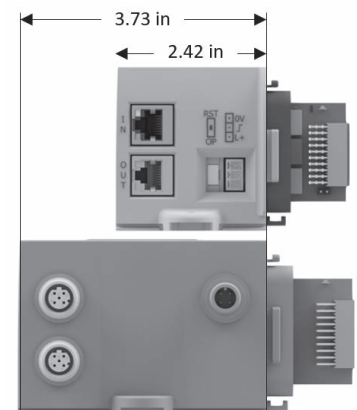

For inventory, lead times, and kit lookup, visit www.pdnplu.com

D165

Parker Hannifin Corporation
 Pneumatic Division
 Richland, Michigan
www.parker.com/pneumatics

D

Subbase & Manual Valves

H Series Micro

Modulflex Series

H Series ISO

Network Connectivity

DX ISOMAX Series

Valvair II Series

Industrial Ethernet Lite Node Connections and Diagnostic Functions

Ethernet and Power Connections

Network Communication Ports:

2 x Standard RJ45 Female connectors

Usage of standard manufactured cables available from your usual electrical supplier is recommended.

Power Supply:

Standard 3-Pin Male Connector - 3,81 mm pitch

Working mode selector:

DIP-switch

Configuration Files

The configuration files can be download from the product web page: www.parker.com/pde/P2M_IE

IP Address Setting

For both Profinet IO and EtherNet/IP™ protocols, the P2M Lite 24DO Node is by default in DHCP mode. The module must be assigned to a static IP-Address in order to be controlled via network. Please, refer to the user manual for IP-Address assignment process.

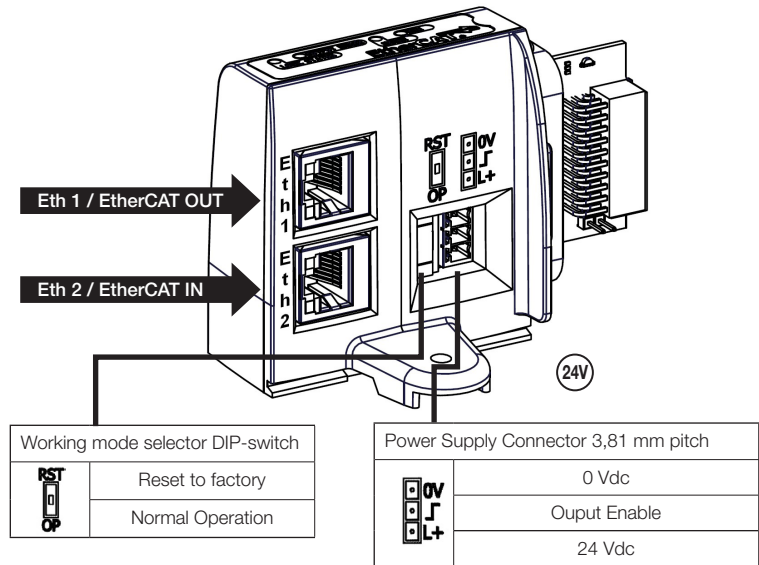

Local and Network Diagnostic Functions

Local Diagnostic

The P2M Lite 24DO node offers a local diagnostic via 9 LED's. Please refer to user manual with interpretation table.

Network Diagnostic

The P2M Lite 24DO Node offers additional useful module status information:

- Pilot overload or short circuit
- Power Voltage out of tolerance
- Cycle counter for every pilot
- Module temperature

For detailed technical information on the P2M Lite 24DO Node and a complete interpretation of node's diagnostic functionalities, please refer to the User Manual available from the product web page:

www.parker.com/pde/P2M_IE

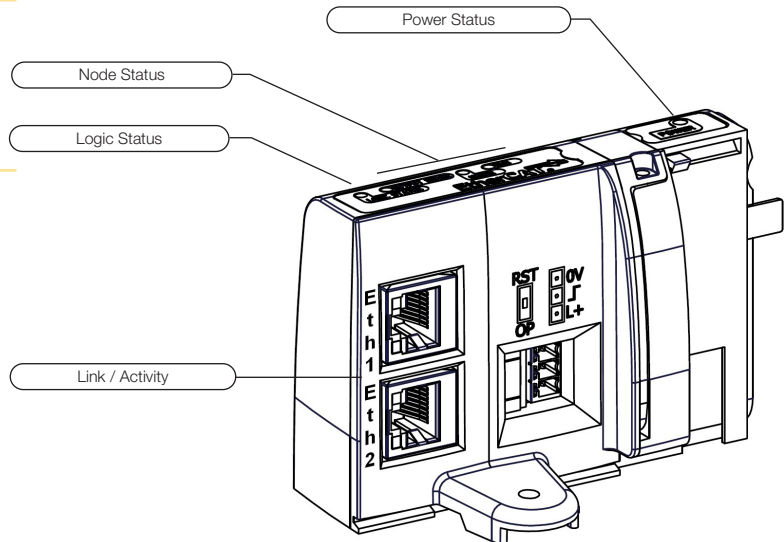

EtherNet/IP™



EtherCAT®

D
 Subbase & Manual Valves
 H Series Micro
 Modulflex Series
 H Series ISO
 Network Connectivity
 DX ISOMAX Series
 Valvair II Series



For inventory, lead times, and kit lookup, visit www.pdnplu.com

D166

Parker Hannifin Corporation
 Pneumatic Division
 Richland, Michigan
www.parker.com/pneumatics

Valve Island V Series with IO-Link connection

The P2M Moduflex IO-Link 24 DO node allows a very simple and cost efficient connection to any IO-Link master, centralised into the PLC or decentralised through an industrial Ethernet network.

Designed in both Class A and Class B versions with an isolated auxiliary power, it can easily be adapted to all power supply architectures and follow machine directives.

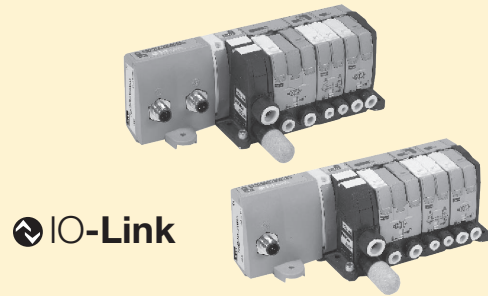

“V” Series Valve Island - P2M head module for IO-Link

Electrical Module for 24 outputs
 (The last 5 outputs of this 24 DO module can not be used with Moduflex Valve)



M12 A coded Connector connection

Description	IO-Link class	IO-Link	Aux. power	Aux. power pinout	Weight (g)	Part number	
						Standard	Safe power capable
Class A P2M IO-Link communication module	Class A	3 Pin's	3 Pin's	1 & 3	160	P2M2HBVL12400A13	P2M2HBVL12400A13-SPC
				4 & 3	160	P2M2HBVL12400A43	P2M2HBVL12400A43-SPC
				4 & 2	160	P2M2HBVL12400A42	P2M2HBVL12400A42-SPC
Class B	Class B	5 Pin's		2 & 5	140	P2M2HBVL12400B25	P2M2HBVL12400B25-SPC
Power & communication cable						RKC 4.5T*-RSC 4.5T/S1587	

IODD file can be downloaded from IODD Finder or the Moduflex web site:
<https://ioddfinder.io-link.com> or www.parker.com/pdn/io-link

Where * = 1, 2, 3, 4, 5, 10, 20 meter standard lengths

P2M Class A Module with Independent Auxiliary Power Supply

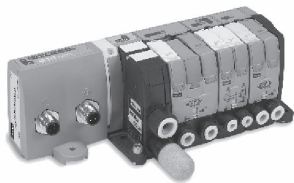

The P2M IO-Link Class A module can handle a Moduflex valve manifold having up to 19 solenoid outputs, or H Series Micro / ISO up to 24 solenoid outputs.

Thanks to its 2 x M12 A coded male connectors, the P2M node can be connected to any IO-Link Class A master and separately receive its auxiliary power supply for valves from an independent source.

The P2M IO-Link Class A module exists in 3 versions with the auxiliary power M12 connector pin out adapted to any sourcing through a standard M12 cable:

- P2M2HBVL12400A13 version: 24VDC / 0VDC on pins 1 & 3 – Standard version
- P2M2HBVL12400A43 version: 24VDC / 0VDC on pins 4 & 3 – Compatible with Siemens wiring
- P2M2HBVL12400A42 version: 24VDC / 0VDC on pins 4 & 2 – Compatible with Rockwell wiring and Turck wiring

P2M Class B Module

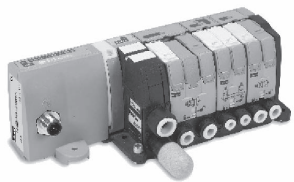

The P2M IO-Link Class B module can handle a Moduflex valve manifold having up to 19 solenoid outputs, or H Series Micro / ISO up to 24 solenoid outputs.

Thanks to its single M12 A coded male connectors, P2M node can be connected to any IO-Link Class B master receiving its auxiliary power supply for valves on pins 2 & 5 from the only cable simplifying the connection.

- P2M2HBVL12400B25 version: 24VDC / 0VDC on pins 2 & 5

Valve Series

Check the total maximum solenoid current consumption against the limit of the power supply and P2M module (standard version 4A, SPC version 2A).



Moduflex Valve
 Cv: .18 - 0.80
 19 Solenoids
 42mA per Sol.

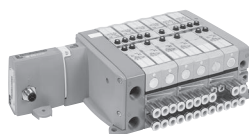

H Micro
 Cv: 0.35
 24 Solenoids
 42mA per Sol.



For inventory, lead times, and kit lookup, visit www.pdnplu.com

D167

Parker Hannifin Corporation
 Pneumatic Division
 Richland, Michigan
www.parker.com/pneumatics

D

Subbase & Manual Valves

H Series Micro

Moduflex Series

H Series ISO

Network Connectivity

DX ISOMAX Series

Valvair II Series

IO-Link Module Connection and Diagnostic Functions



IO-Link Module Connection

Standard male M12 – type A

Usage of standard manufactured cables available from your usual electrical supplier is recommended.

Note: Auxiliary power for solenoids can be wired allowing the user to turn outputs off while the communications remains on.

Configuration

IODD file can be downloaded from IODD Finder or the P2M web site:

<https://ioddfinder.io-link.com>
www.parker.com/pdn/P2M_IOL

Class B

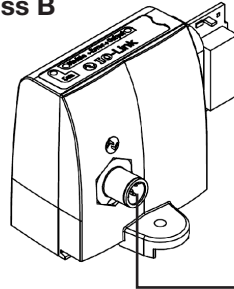

Class A

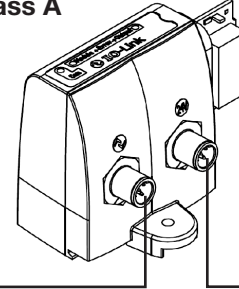

Legend

Symbol	Description
L+	IO-Link power supply "+"
L-	IO-Link power supply "-"
C/Q	IO-Link communication
Aux +	Auxiliary power supply 24 VDC
Aux -	Auxiliary power supply 0 VDC

M12 pin's	Class A		
	3 pin's	5 pin's	
	P2M...A13	P2M...A43	P2M...A42
1	Aux +	Not used	Not used
2	-	-	Aux -
3	Aux -	Aux -	Not used
4	n.c.	Aux +	Aux +
5	-	-	Not used

Auxiliary Power Supply Compatibility

The P2M IO-Link Node can be powered from a 24VDC auxiliary source in PP or PM mode as grounds are isolated.

The P2M Safe Power Capable (-SPC) versions can be connected from a SAFE OSSD test pulsed power source.

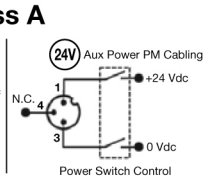
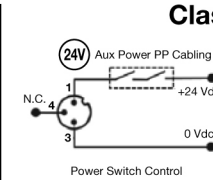
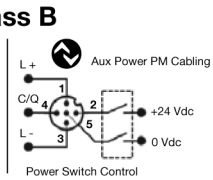
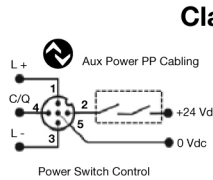

Cabling for P2M2HBVL12400A13

IO-Link Module Diagnostic Functions

The P2M IO-Link module offers additional useful module status information:

- Solenoid overload or short circuit
- Auxiliary voltage out of tolerance
- Cycle counter for each solenoid
- Module temperature

For more information on product technical information and module diagnostic functionalities, please refer to the user manual available from the product web page:

www.parker.com/pdn/P2M_IOL

COM Green LED			Module - Error Red LED			Error - Output Red LED			POWER Green LED		
LED Status	Description	Solving	LED Status	Description	Solving	LED Status	Description	Solving	LED Status	Description	Solving
OFF	IO-Link L+ / L- not powered	Check connection	OFF	Standard mode	NA	OFF	Standard mode	NA	OFF	AUX power failure	Check Auxiliary Power Supply
ON	IOL L+ / L- powered IO mode	Set IO-Link mode in IO-Link master	ON	24 VDC AUX power missing or any active malfunction	Check power supply or change module	ON	Any driver error (overload, over temperature, etc.)	Fix solenoid issue then acknowledge error	ON	Standard	NA
Blinking	IO-Link communication active	NA							Blinking	Aux Power is out of range, alarm level	Check Auxiliary Power Supply

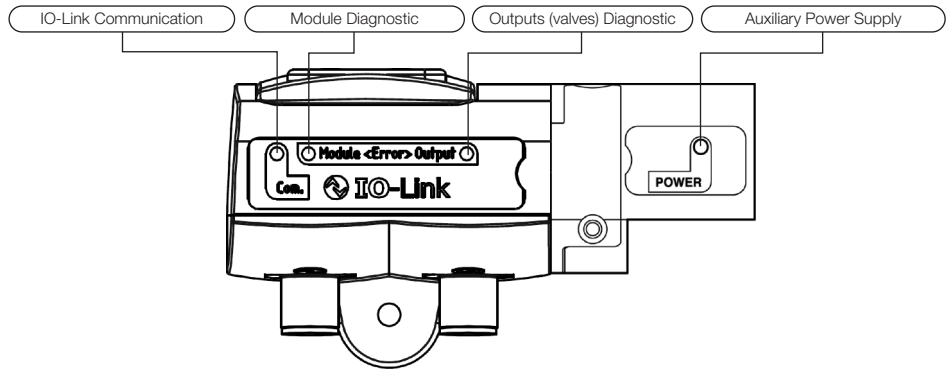

D
Subbase & Manual Valves
H Series Micro
Modulflex Series
H Series ISO
Network Connectivity
DX ISOMAX Series
Valvair II Series



For inventory, lead times, and kit lookup, visit www.pdnplu.com

D168

Parker Hannifin Corporation
 Pneumatic Division
 Richland, Michigan
www.parker.com/pneumatics

Input Data

One byte of diagnostic input data is transferred from P2M IO-Link to the IO-Link Master.

Process input data

7	6	5	4	3	2	1	0
Output driver SPI error	Output driver channel error	Polyfuse tripped	Temperature warning	SPI error	AUX voltage error	AUX voltage warning	Acknowledge Required

Output Data

Three bytes of process data are received by P2M IO-Link from the IO-Link Master for control of solenoids.

Process output data (Byte 0)

7	6	5	4	3	2	1	0
EV8	EV7	EV6	EV5	EV4	EV3	EV2	EV1

Process output data (Byte 1)

7	6	5	4	3	2	1	0
EV16	EV15	EV14	EV13	EV12	EV11	EV10	EV9

Process output data (Byte 2)

7	6	5	4	3	2	1	0
EV24	EV23	EV22	EV21	EV20	EV19	EV18	EV17

Solenoid Pilots Addressing and Process Mapping

P2M IO-Link node addressing used with Moduflex Valve System

The P2M IO-Link node, when used with Moduflex Valve System can handle up to 19 pilot solenoid valves. Addressing will be done as shown below.

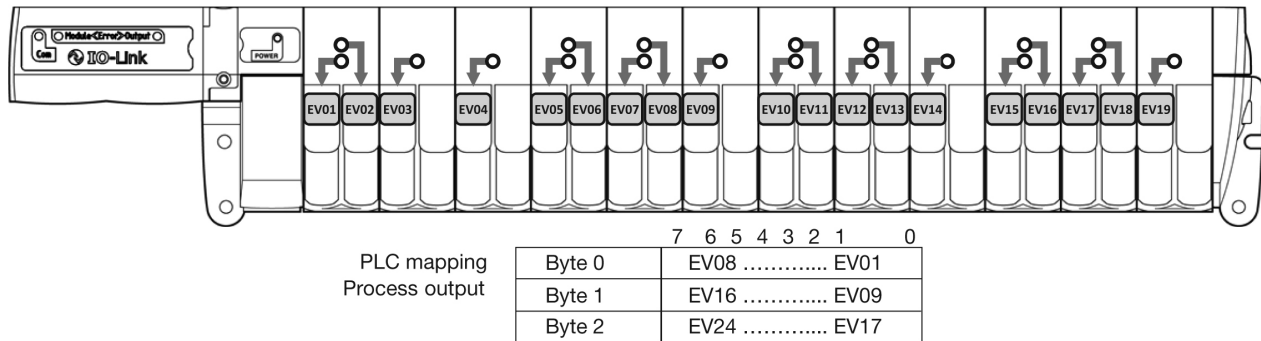

P2M IO-Link Module Electrical Specifications

IO-Link power supply	According to IO-Link standard V1.1.2
Speed communication	Com 2 – 38 kBd
Auxiliary power supply	20.4 VDC to 26.4 VDC
Current limit per channel	150 mA
Max current limit	4 A
Polarity inversion	YES
Short circuit protection	YES
Operating temperature	0°C to 55°C
Storage temperature	-25°C to 70°C
Shock according to IEC	60068-2-27:2008
Vibration according to IEC	60068-2-6:2007
EMC according to IEC	61000-4-2 up to -4-6

Network Diagnostic Through Process Mapping:

The P2M IO-Link module offers diagnostic data transmitted to the PLC through the master:

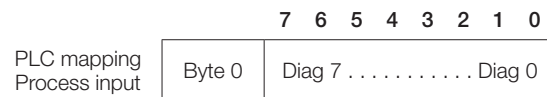

Diag bit	Error message	Detail
Diag 0.....	Fail-safe status	Acknowledgement required
Diag 1.....	Auxiliary voltage warning.....	Check auxiliary power
Diag 2.....	Auxiliary voltage failure.....	Check auxiliary power
Diag 3.....	Module failure	Module HS. must be replaced
Diag 4.....	Module over-temperature	
Diag 5.....	Module over-load	
Diag 6.....	Pilot solenoid(s) short circuit.....	Solenoid must be replaced
Diag 7.....	Outputs stage failure	

For further details, refer to the user manual: can be downloaded from www.parker.com/pdn/P2M_IOL



For inventory, lead times, and kit lookup, visit www.pdnplu.com

Solenoid Pilot Diagnostic Common to All P2M Nodes

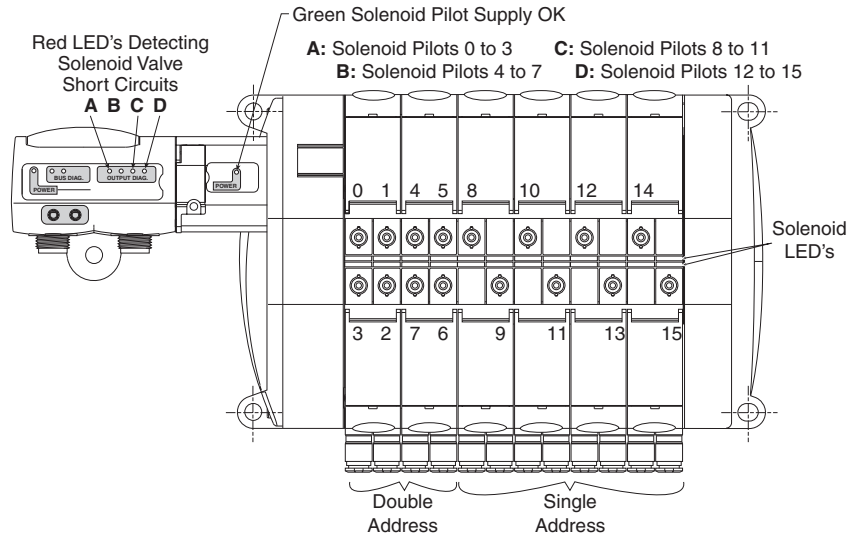

Inside the communication module, solenoid valve control is protected against short-circuits with the following visual indication provided:

- The red LEDs with code, shown above, detect solenoid valve short-circuits
- Supply is OK when the solenoid pilot power supply indicator is green

D
Subbase & Manual Valves
H Series Micro
Modulflex Series
H Series ISO
Network Connectivity
DX ISOMAX Series
Valvair II Series



For inventory, lead times, and kit lookup, visit www.pdnplu.com

D170

Parker Hannifin Corporation
 Pneumatic Division
 Richland, Michigan
www.parker.com/pneumatics

Features

P2H IO-Link Node 24 DO

The P2H Network Node is available with IO-Link connectivity for the industries first connection of ISO valves (5599 & 15407) to the low cost IO-Link network.

Features

- Compact, robust product design
- Weld splatter resistant housing material
- Simple connection to IO-Link Class A or Class B masters
- Industries first power in & out capability for Class A version
- Industries first 7/8" power connectors on Class A version
- IO-Link connection to new H Series ISO Universal Manifold, capable of mixing valve sizes from 0.5 Cv – 3 Cv
- Safe Power Capable for supplying valve power from a safety device (ie. safe relay)
- Diagnostics made SIMPLE! Useful diagnostic flags in process (cyclic) data for easy access and use for preventative maintenance
- Certified to IP65 ingress protection
- CE certification

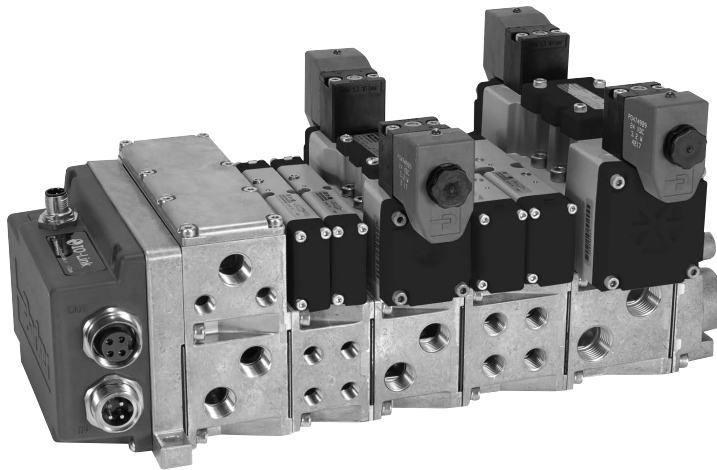

Class A Node

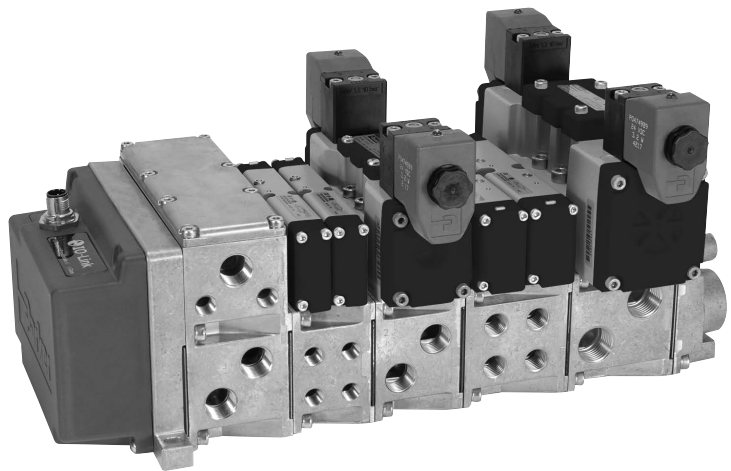

Class B Node

D

Subbase & Manual Valves

H Series Micro

Moduflex Series

H Series ISO

Network Connectivity

DX ISOMAX Series

Valvair II Series



For inventory, lead times, and kit lookup, visit www.pdnplu.com

D171

Parker Hannifin Corporation
Pneumatic Division
Richland, Michigan
www.parker.com/pneumatics

Features

Overview - P2H IO-Link Node 24 DO

Designed to integrate directly with all H Series ISO valve sizes, the P2H IO-Link Network Node provides a compact, robust and cost efficient solution for IO-Link capability. The P2H IO-Link network node is offered as an end plate kit on the H Series valve for five sizes (HB, HA, H1, H2 and H3). The P2H node is suitable for use on a valve manifold with up to 24 solenoid outputs.

Connection Types and Power:

Class A Node

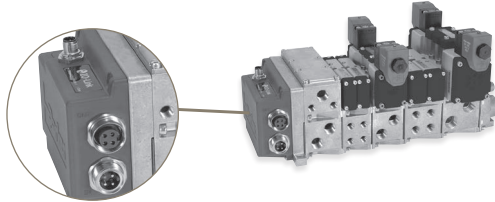

The Class A node has (1) 3 pin M12 connector for communication and logic power from any class A IO-Link master, and (2) 7/8" connectors for auxiliary valve power IN and OUT.

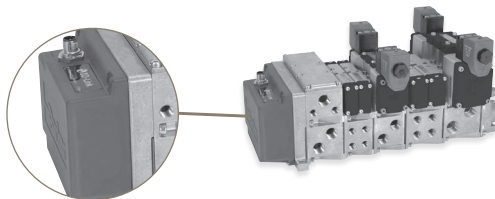

Class B Node



The Class B node has (1) 5 pin M12 connector to connect IO-Link for communication to a Class B IO-Link master, logic power and auxiliary power for the valve solenoids (up to the limit of the Class B node output*).

*It is recommended to use the Class A node with auxiliary power if the Class B master cannot provide enough power.

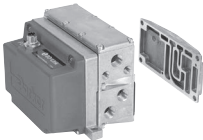
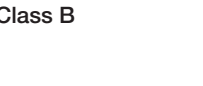
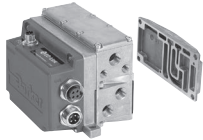
Left and Right Hand End Plate

	IO-Link class / type	Current	HB, HA, H1, H2 Valves		H3 Valves	
			NPT port	BSPP port	NPT port	BSPP port
 Class B	P2H IO-Link Class B, standard version, 24 address	3.2A max	PSHU20N200P	PSHU20N201P	PS4220N20DP	PS4220N21DP
 Class B	P2H IO-Link Class B, Safe Power Capable, 24 address	2.0A max	PSHU20S200P	PSHU20S201P	PS4220S20DP	PS4220S21DP
 Class A	P2H IO-Link Class A, 4-pin Safe Power Capable, 24 address	3.2A max	PSHU20S400P	PSHU20S401P	PS4220S40DP	PS4220S41DP
 Class A	P2H IO-Link Class A, 5-pin Safe Power Capable, 24 address	3.2A max	PSHU20S500P	PSHU20S501P	PS4220S50DP	PS4220S51DP

www.parker.com/pdn/P2H_IOL

Description	Standard version	- Safe power capable versions
IO-Link power supply	According to IO-Link standard V1.1.2	
Speed communication	Com 2 – 38 kBd	
Auxiliary power supply	voltage	20,4 VDC to 26,4 VDC
	OSSD compatibility	No Yes
Short circuit protection	Yes	
Operating temperature	0°C to +55°C	
Shock	According to IEC 60068-2-27:2008	
Vibration	According to IEC 60068-2-6:2007	
EMC	According to EN 55011 & EN 61000-4-2 to -4-6	
Ingress protection	Certified to IP65	

D
 Subbase & Manual Valves
 H Series Micro Series
 Modulflex Series
 H Series ISO
 Network Connectivity
 DX ISOMAX Series
 Valvair II Series



For inventory, lead times, and kit lookup, visit www.pdnplu.com

P2H IO-Link Node 24 DO – Connections and LED Diagnostics

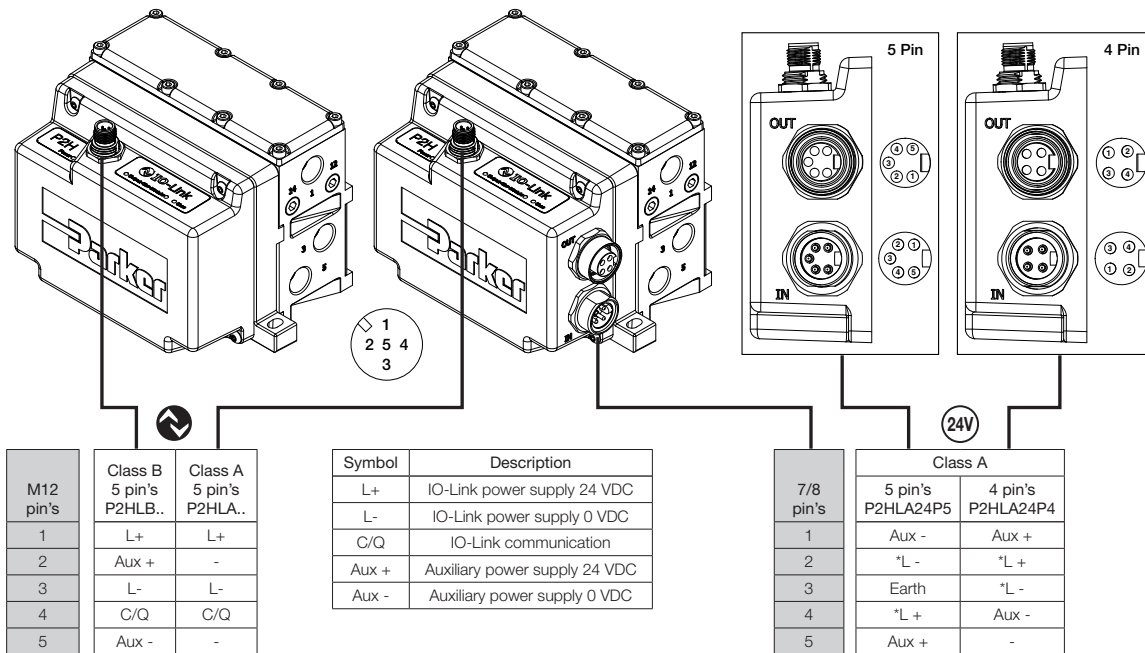

Note:

*7/8" logic power has no connection to internal P2H unit but does carryover to OUT 7/8" connector (for jumper logic power only). Logic power for P2H unit will be supplied from M12 (pin 1 & 3)

Local diagnostic through LED:

The P2H IO-Link Node offers a local diagnostic through 4 LED's status with interpretation described in the table below:

Power Green LED			Output<Err> Red LED			<Err>Module Red LED			Com Green LED		
LED Status	Description	Solving	LED Status	Description	Solving	LED Status	Description	Solving	LED Status	Description	Solving
OFF	Auxiliary power failure < 18V or > 28.5V	Check auxiliary power supply	OFF	Standard mode (No error active)	N/A	OFF	Standard mode (No error active)	N/A	OFF	IO-Link L+ / L- line not powered	Check IO-Link power supply from IO-Link Master (pin's 1 & 3)
ON	Standard mode (auxiliary power within normal range 20.4V* to 26.4V*)	N/A	ON	Any outputs driver error (auxiliary power error, overload, short circuit, over temperature, ...)	If auxiliary power OK (see Power LED status), check error messages and related troubleshooting	ON	24 VDC auxiliary power missing or any active malfunction	Check Auxiliary power supply. If auxiliary power supply OK, module must be replaced	ON	IO-Link L+ / L- line powered IO-Link master port set as SIO mode	Set IO-Link master channel in IO-Link mode
Blinking	Auxiliary power out of range (warning level*)	Check auxiliary power supply, check/reset adjusted values							Blinking	IO-Link communication active	N/A

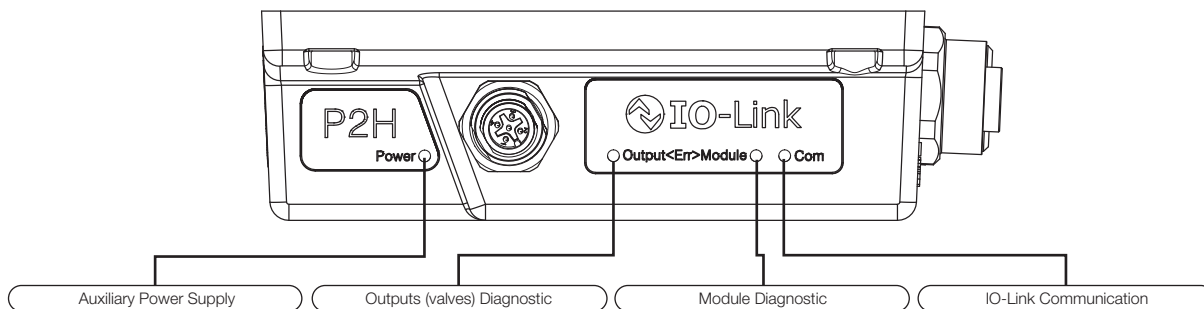

P2H IO-Link Node 24 DO – Connections and LED Diagnostics

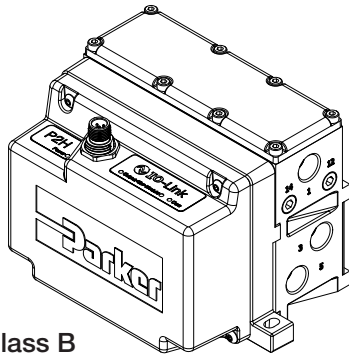

Class B

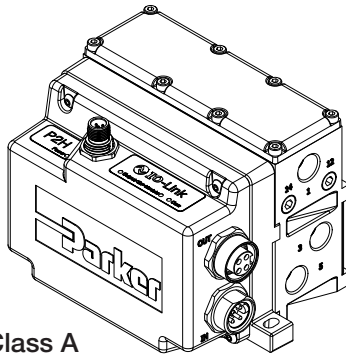

Class A

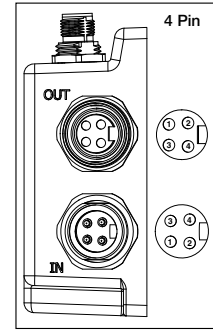
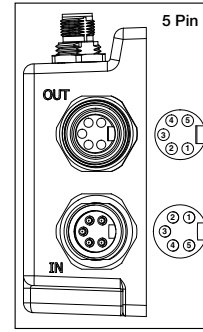

P2H IO-Link 24DO Node connection to SAFE Power PP / PM mode for valve control

The P2H IO-Link 24DO node can be powered from a SAFE 24 VDC auxiliary source in PP or PM mode as grounds are isolated. Auxiliary power for solenoids can be wired allowing the functionality to turn outputs OFF while communications remain active.

Class A – 5 Pin

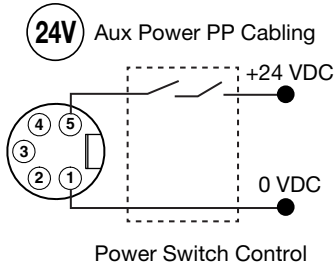

Power Switch Control

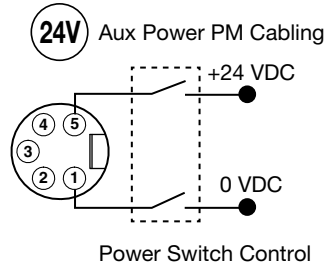

Power Switch Control

Pin Number	Address
1	AUX-
2	*L-
3	Earth
4	*L+
5	AUX+

Class A – 4 Pin

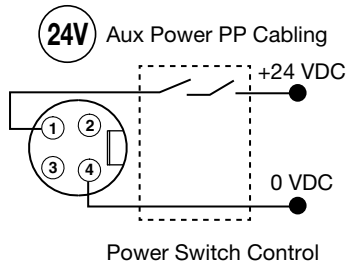

Power Switch Control

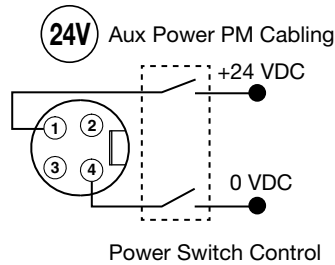

Power Switch Control

Pin Number	Address
1	AUX+
2	*L+
3	*L-
4	AUX-

Class B

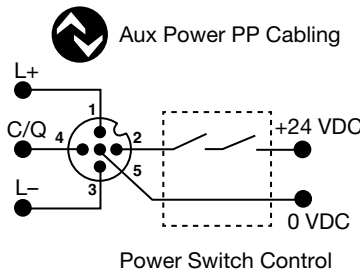

Power Switch Control

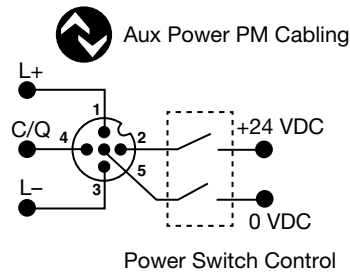

Power Switch Control

Pin Number	Address
1	L+
2	AUX+
3	L-
4	C/Q
5	AUX-

* 7/8" logic power has no connection to internal P2H unit but does carryover to OUT 7/8" connector (for jumper logic power only). Logic power for P2H unit will be supplied from M12 (pin 1 & 3).

D
 Subbase & Manual Valves
 H Series Micro
 Modflex Series
 H Series ISO
 Network Connectivity
 DX ISOMAX Series
 Valvair II Series



For inventory, lead times, and kit lookup, visit www.pdnplu.com

P2H IO-Link Node 24 DO – Input / Output Data Mapping

Input Data

One byte of diagnostic input data is transferred from Moduflex to the IO-Link Master.

Process Input Data

7	6	5	4	3	2	1	0
Output driver SPI error	Output driver channel error	Polyfuse tripped	Temperature warning	SPI error	Aux voltage error	Aux voltage warning	Acknowledge required

Diag bit	Error Message	Detail
Diag 0	Fail-safe status	Acknowledgment required
Diag 1	Auxiliary voltage warning	Auxiliary voltage out of range, check auxiliary power line
Diag 2	Auxiliary voltage failure	Auxiliary voltage out of order, check auxiliary power source
Diag 3	Module failure	Switch OFF / ON auxiliary power, if error message persists, replace the module
Diag 4	Module over-temperature	Switch OFF / ON auxiliary power, if error message persists, replace the module
Diag 5	Module over-load	Check overall pilot solenoid valves, if error message persists, replace the module
Diag 6	Pilot solenoid(s) short circuit	Check faulty pilot solenoid valve(s), replace if necessary
Diag 7	Outputs stage not available	Auxiliary power is OFF

Output Data

Three bytes of process data are received by Moduflex from the IO-Link Master for control of solenoids.

Process Output Data (Byte 0)

7	6	5	4	3	2	1	0
EV8	EV7	EV6	EV5	EV4	EV3	EV2	EV1

Process Output Data (Byte 1)

7	6	5	4	3	2	1	0
EV16	EV15	EV14	EV13	EV12	EV11	EV10	EV9

Process Output Data (Byte 2)

7	6	5	4	3	2	1	0
EV24	EV23	EV22	EV21	EV20	EV19	EV18	EV17

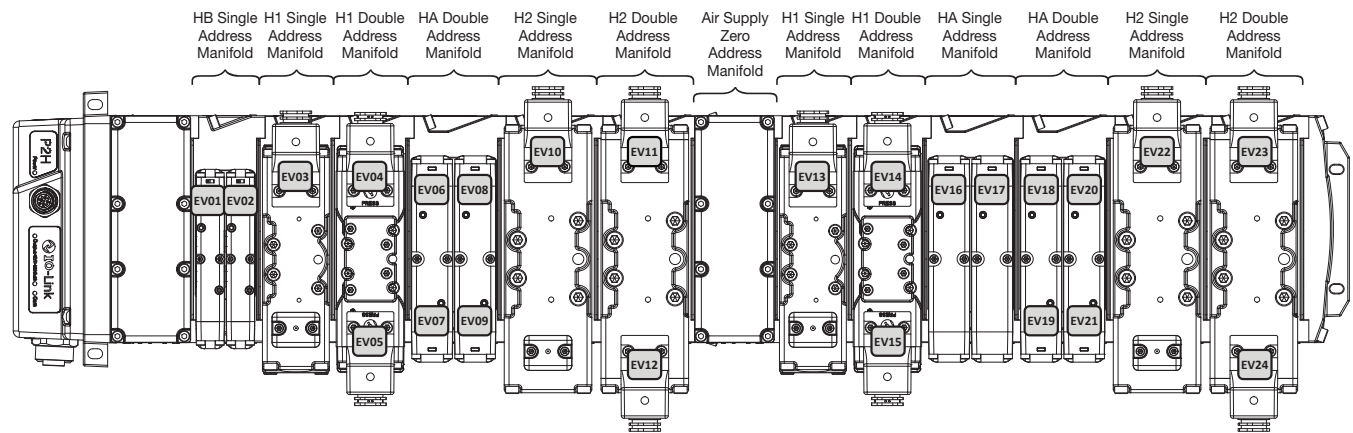

PLC Process outputs data mapping	7 0
Byte 0	EV08 EV01
Byte 1	EV16 EV09
Byte 2	EV24 EV17

Configuration IODD File

IODD file can be downloaded from IODD Finder or the P2H IO-Link web site:

- <https://ioddfinder.io-link.com>
- www.parker.com/pdn/P2H_IOL



For inventory, lead times, and kit lookup, visit www.pdnplu.com

D175

Parker Hannifin Corporation
 Pneumatic Division
 Richland, Michigan
www.parker.com/pneumatics

D

Subbase & Manual Valves

H Series Micro

Moduflex Series

H Series ISO

Network Connectivity

DX ISOMAX Series

Valvair II Series

Features

P2H Ethernet Node 32 DO

The P2H Ethernet Node has been designed to be connected to a many popular Ethernet Networks. It can be used with Parker’s H-Universal ISO 15407-2 (size 02 & 01) and 5599-2 (sizes 1, 2 & 3) valve series. It can control up to 32 pilot solenoid addresses with different power configuration options available and provides local visual and remote diagnostics through the Network. Designed for industrial environments, the P2H Ethernet Node is constructed of PBT material, which is glass-filled and offers weld splatter resistance, UV stability and has significant flame-retardant properties making it suitable for the durability required in industrial applications with high heat and welding applications.

Features

Industrial Ethernet Protocols:

- EtherNet/IP
- Profinet
- EtherCAT
- Modbus TCP
- Powerlink

Power Options:

- Power IN/OUT Connection
- 7/8 4 pin
- 7/8 5 pin
- L- Code M12 5 pin
- Safe Power Capable
- OSSD Compatible

Environment:

- IP65
- Weld Spatter Resistant
- Weld Noise Immune

Diagnostics:

- PLC
- Web Interface
- Network Specific LED’s

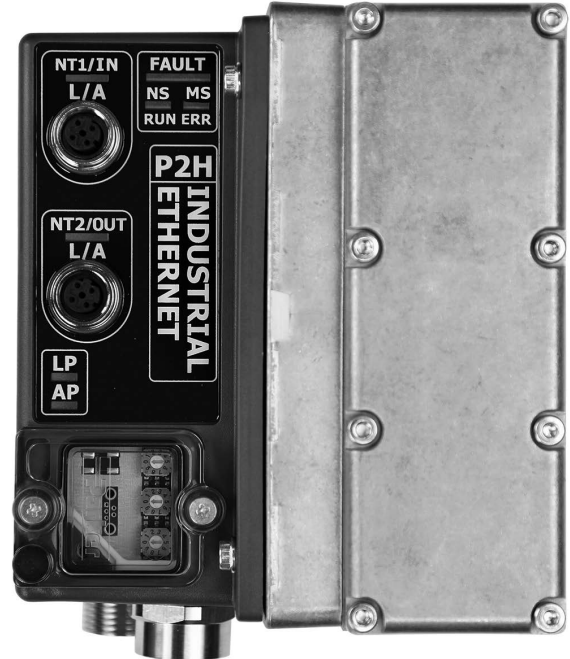
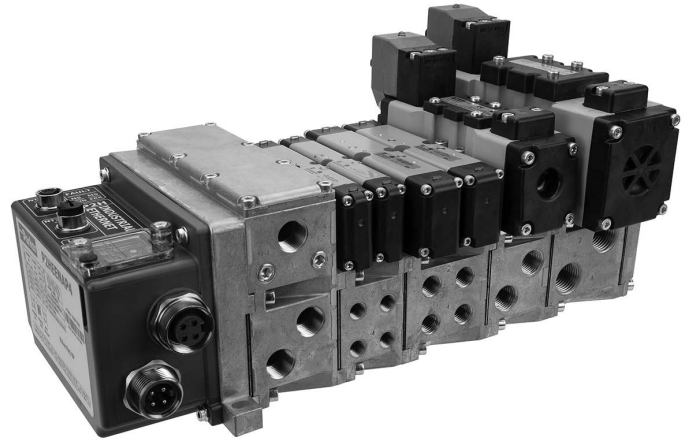

D
Subbase & Manual Valves
H Series Micro
Modulflex Series
H Series ISO
Network Connectivity
DX ISOMAX Series
Valvair-II Series









For inventory, lead times, and kit lookup, visit www.pdnplu.com

D176

Parker Hannifin Corporation
Pneumatic Division
Richland, Michigan
www.parker.com/pneumatics

Ordering Information

P2H Ethernet Node 32 DO - Popular Module Combinations

- Listed below are popular module configurations
- For full model number structure, please refer to next page

EtherNet/IP™

Popular Part Number Configurations				
Pilot Type	Thread Type	Power Source for Output 25-32	Power Connector	End Plate Part Number
Internal	NPT	Aux Power	7/8" 4-pin power IN/OUT with 1 safe power capable zone	PSHU20P200PE000A-P4
Internal	NPT	Logic Power Isolated from Aux Power	7/8" 4-pin power IN/OUT with 1 safe power capable zone	PSHU20P200PE000L-P4
Internal	NPT	Aux Power	7/8" 5-pin power IN/OUT with 1 safe power capable zone	PSHU20P200PE000A-P5
Internal	NPT	Logic Power Isolated from Aux Power	7/8" 5-pin power IN/OUT with 1 safe power capable zone	PSHU20P200PE000L-P5
Internal	NPT	Aux Power	M12 L-Coded, 5-pin power IN/OUT with 1 safe power capable zone	PSHU20P200PE000A-L5
Internal	NPT	Logic Power Isolated from Aux Power	M12 L-Coded, 5-pin power IN/OUT with 1 safe power capable zone	PSHU20P200PE000L-L5



Popular Part Number Configurations				
Pilot Type	Thread Type	Power Source for Output 25-32	Power Connector	End Plate Part Number
Internal	NPT	Aux Power	7/8" 4-pin power IN/OUT with 1 safe power capable zone	PSHU20P200PN000A-P4
Internal	NPT	Logic Power Isolated from Aux Power	7/8" 4-pin power IN/OUT with 1 safe power capable zone	PSHU20P200PN000L-P4
Internal	NPT	Aux Power	7/8" 5-pin power IN/OUT with 1 safe power capable zone	PSHU20P200PN000A-P5
Internal	NPT	Logic Power Isolated from Aux Power	7/8" 5-pin power IN/OUT with 1 safe power capable zone	PSHU20P200PN000L-P5
Internal	NPT	Aux Power	M12 L-Coded, 5-pin power IN/OUT with 1 safe power capable zone	PSHU20P200PN000A-L5
Internal	NPT	Logic Power Isolated from Aux Power	M12 L-Coded, 5-pin power IN/OUT with 1 safe power capable zone	PSHU20P200PN000L-L5

EtherCAT®

Popular Part Number Configurations				
Pilot Type	Thread Type	Power Source for Output 25-32	Power Connector	End Plate Part Number
Internal	NPT	Aux Power	7/8" 4-pin power IN/OUT with 1 safe power capable zone	PSHU20P200PT000A-P4
Internal	NPT	Logic Power Isolated from Aux Power	7/8" 4-pin power IN/OUT with 1 safe power capable zone	PSHU20P200PT000L-P4
Internal	NPT	Aux Power	7/8" 5-pin power IN/OUT with 1 safe power capable zone	PSHU20P200PT000A-P5
Internal	NPT	Logic Power Isolated from Aux Power	7/8" 5-pin power IN/OUT with 1 safe power capable zone	PSHU20P200PT000L-P5
Internal	NPT	Aux Power	M12 L-Coded, 5-pin power IN/OUT with 1 safe power capable zone	PSHU20P200PT000A-L5
Internal	NPT	Logic Power Isolated from Aux Power	M12 L-Coded, 5-pin power IN/OUT with 1 safe power capable zone	PSHU20P200PT000L-L5



For inventory, lead times, and kit lookup, visit www.pdnplu.com

D177

Parker Hannifin Corporation
Pneumatic Division
Richland, Michigan
www.parker.com/pneumatics

D

Subbase & Manual Valves

H Series Micro

Modulflex Series

H Series ISO

Network Connectivity

DX ISOMAX Series

Valvair II Series

Ordering Information

P2H Ethernet Node 32 DO - Overview

Designed to integrate directly with all H Series ISO valve sizes, the P2H Ethernet Network Node provides a compact, robust and cost-efficient solution for industrial ethernet connectivity to a PLC or other controls device that supports industrial ethernet protocols. The P2H Ethernet Network Node is offered as an end plate kit on the H Series valve for five sizes (HB, HA, H1, H2 and H3). The P2H Ethernet Network Node is suitable for use on a valve manifold with up to 32 solenoid outputs. P2H Ethernet Node connects to a network with two standard M12 D-coded connections. These two connections function as a switch to enable the network to be connected to another network device.

Power connectors are available in three styles:

- 7/8 4-pin
- 7/8 5-pin
- M12 L-Code 5-pin

The power connectors are arranged in an IN/OUT design, and this allows the flexibility to connect power to another down stream device, instead of running two separate cables from a power supply. Each power connector can supply up to 12 A of current on both Logic and Auxiliary power pins. All power connections support (OSSD) test pulsing if the P2H Ethernet Node is connected to a safety rated output device that uses test pulses to detect faults in a safety system.

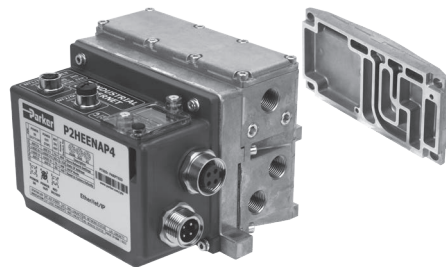

PSHU20 P2 0 0 P E 000 A - P4

Valve Type	
Plug-in (Internal pilot)	PSHU20
Plug-in (External pilot)	PSHU2X

Thread Type	
NPT	0
BSPP "G"	1

Network Connections	
EtherNet/IP™	E
EtherCAT	T
PROFINET	N
Modbus TCP	M
Powerlink	W

Power Connector	
7/8 4-pin Power IN/OUT with 1 Safe Power Capable Zone	P4
7/8 5-pin Power IN/OUT with 1 Safe Power Capable Zone	P5
M12 L-Code 5-pin IN/OUT with 1 Safe Power Capable Zone	L5

Right Hand End Plate Type / Thread Size	
Low profile (no ports)	0
1/2 Exhaust and Inlet Port	1
3/4 Exhaust and Inlet Port	2
H3 Transition Plate and End Plate (electrical pass through for plug-in valves only)	3
H3 Transition Plate and End Plate (expansion to 25th address for plug-in valves only)	4

Expansion Module / Power Source	
Power Source for Output 25-32: AUX Power	A
Power Source for Output 25-32: Logic Power	L

D

Subbase & Manual Valves

H Series Micro

Modulflex Series

H Series ISO

Network Connectivity

DX ISOMAX Series

Valvair-II Series



For inventory, lead times, and kit lookup, visit www.pdnplu.com

D178

Parker Hannifin Corporation
Pneumatic Division
Richland, Michigan
www.parker.com/pneumatics

P2H Ethernet Node 32 DO - Expansion Module

Note: An optional intermediate air supply module must be installed to the manifold for expansion from 25 – 32 solenoids, 24 to 31 addresses.

PSHU115A E 1 P

Mounting Style / Port Size	
Intermediate Air Supply, NPT / Internal Pilot	PSHU115A
Intermediate Air Supply, BSPP / Internal Pilot	PSHU115B*
Intermediate Air Supply, NPT / External Pilot	PSHU115C
Intermediate Air Supply, BSPP / External Pilot	PSHU115D*

* BSPP conforms to ISO 1179-1 w 228-1 threads.

Gasket Options	
1	1,3,5 Ports Open And Pilots Open
2	1,3,5 Ports Closed And Pilots Open
3	1 Closed, 3,5 Ports Open And Pilots Open
4	1 Port Open, 3,5 Ports Closed And Pilots Open
5	1,3,5 Ports Open And Pilots Closed
6	1,3,5 Ports Closed And Pilots Closed
7	1 Closed, 3,5 Ports Open And Pilots Closed
8	1 Port Open, 3,5 Ports Closed And Pilots Closed

Circuit Board Address Configuration
 With Electrical Expansion
 To 24th Address



Intermediate air supply module shown

Address Numbers

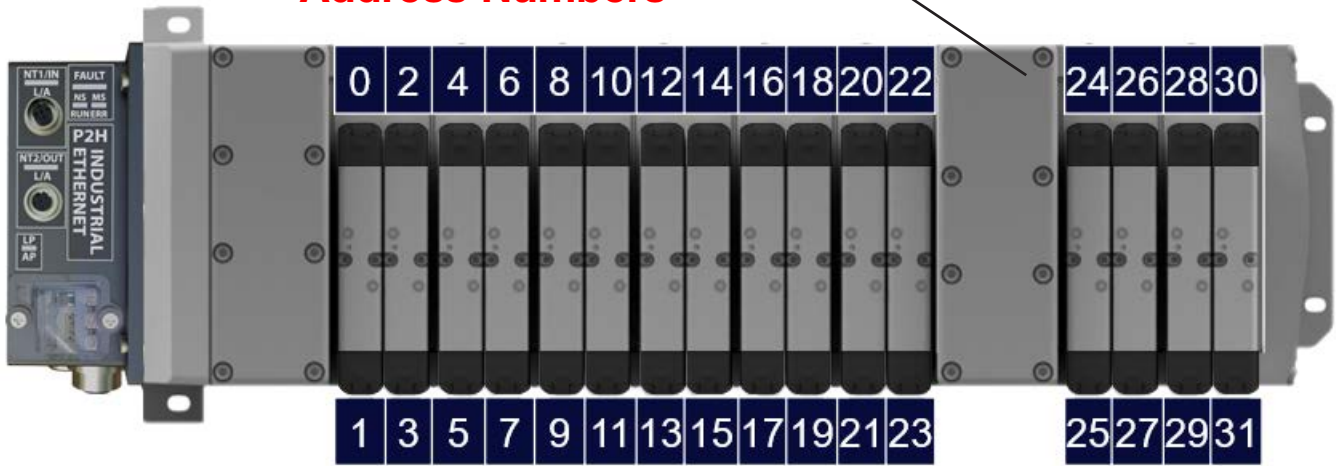

D
Subbase & Manual Valves
H Series Micro
Modulflex Series
H Series ISO
Network Connectivity
DX ISOMAX Series
Valvair II Series

Ordering Information

P2H Ethernet Node 32 DO - Network Interface

The P2H Node 32DO allows connection to an industrial Ethernet Network via two M-12 D-Coded connectors (NT1 and NT2). An embedded switch allows for daisy-chaining ethernet communications. The connectors pin assignments are as follows:

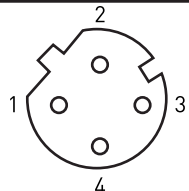
M12, D-coded, Female	Pin No.	Function
	1	Tx+
	2	Rx+
	3	Tx-
	4	Rx-

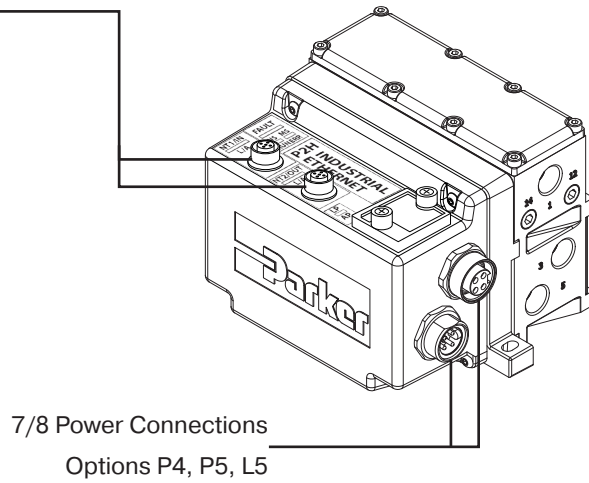

D

Subbase & Manual Valves

H Series Micro

Modulflex Series

H Series ISO

Network Connectivity

DX ISOMAX Series

Valvair II Series

Industrial Ethernet Options



Network Connections	
EtherNet/IP™	E
EtherCAT	T
PROFINET	N
Modbus TCP	M
Powerlink	W



For inventory, lead times, and kit lookup, visit www.pdnplu.com

P2H Ethernet Node 32 DO - Power Options

- The P2H Ethernet Network Node has 3 available power connectors
- There are two power schemes that can be achieved detailed below
- H ISO Universal manifold valves draw power from the AUX power pins of the power connector

Consumption @ 24 VDC

AUX power max consumption	12A
Logic power max consumption	12A

Left over power that is not used by the P2H Ethernet Node can be passed on to other devices in the system through the power OUT connector



Power Connector *	
7/8 4-pin power in/out with 1 safe power capable zone	P4
7/8 5-pin power in/out with 1 safe power capable zone	P5
M12 L-Code 5-Pin in/out with 1 Safe Power Capable zone	L5

Power Connection Layout

The following three types of power connectors are available based on the end user's requirement. Current considerations should be used in the power connection selection process. Each power connection type can support a maximum of 12 A of current on each channel (VAUX and VLOG). When daisy chaining power is used, care must be taken in knowing the downstream current draw in order not to overload the maximum current rating of the pins.

	P4 - 7/8", 4-pin	P5 - 7/8", 5-pin	L5 - L-Coded, M12						
TOP CONNECTOR	Power OUT 	Power OUT 	Power OUT 						
	Pin	Function	Description	Pin	Function	Description	Pin	Function	Description
	1	+ 24 V	V2 (VAUX)	1	0 V	GND V2 (VAUX)	1	+ 24 V	V1 (VLOG)
	2	+ 24 V	V1 (VLOG)	2	0 V	GND V1 (VLOG)	2	0 V	GND V2 (VAUX)
	3	0 V	GND V1 (VLOG)	3	PE	Protective Earth	3	0 V	GND V1 (VLOG)
4	0 V	GND V2 (VAUX)	4	+ 24 V	V1 (VLOG)	4	+ 24 V	V2 (VAUX)	
			5	+ 24 V	V2 (VAUX)	5	PE	Protective Earth	
BOTTOM CONNECTOR	Power IN 	Power IN 	Power IN 						
	Pin	Function	Description	Pin	Function	Description	Pin	Function	Description
	1	+ 24 V	V2 (VAUX)	1	0 V	GND V2 (VAUX)	1	+ 24 V	V1 (VLOG)
	2	+ 24 V	V1 (VLOG)	2	0 V	GND V1 (VLOG)	2	0 V	GND V2 (VAUX)
	3	0 V	GND V1 (VLOG)	3	PE	Protective Earth	3	0 V	GND V1 (VLOG)
4	0 V	GND V2 (VAUX)	4	+ 24 V	V1 (VLOG)	4	+ 24 V	V2 (VAUX)	
			5	+ 24 V	V2 (VAUX)	5	PE	Protective Earth	

*PE – Protective Earth



For inventory, lead times, and kit lookup, visit www.pdnplu.com

D181

Parker Hannifin Corporation
 Pneumatic Division
 Richland, Michigan
www.parker.com/pneumatics

D

Subbase & Manual Valves

H Series Micro

Moduflex Series

H Series ISO

Network Connectivity

DX ISOMAX Series

Valvair II Series

Ordering Information

P2H Ethernet Node 32 DO - Power Scheme 1 Option "A"

- All 32 addresses are controlled in the same power zone
- Safety zoning is possible for valve solenoids and, with the H ISO Universal valves, pneumatic pressure
- Power zone is safe power capable

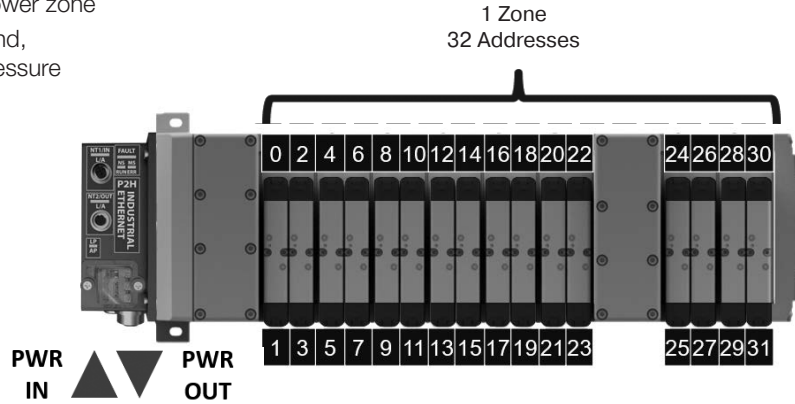

Power Scheme 2 Option "L"

- The 1st 24 addresses are supplied by axillary voltage power. The last 8 addresses are supplied by the logic voltage power.
- Each zone has an isolated safe ground pin so each can be powered by a SAFE 24 VDC auxiliary source in PP or PM mode. **NOTE:** You can treat each zone as a separate power zone/safe zone. Be aware that the last 8 addresses will be supplied by logic power. If power is shut down to this zone the P2H Ethernet module loses power and communication. This may cause extra time to reconnect to the network when power is restored.

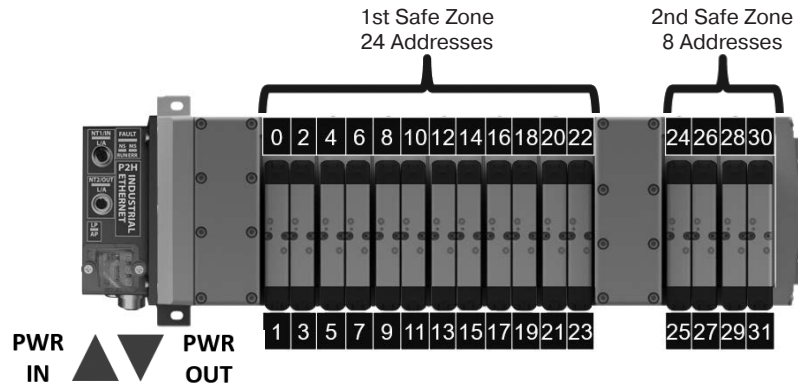

Industrial Ethernet Options

XXXXXX P2 X X P X 000 A - XX

Expansion Module / Power Source	
Power Source for Output 25-32: AUX Power	A
Power Source for Output 25-32: Logic Power	L

D	Subbase & Manual Valves
H Series Micro	Modulflex Series
H Series ISO	Network Connectivity
DX ISOMAX Series	Valvair-II Series



For inventory, lead times, and kit lookup, visit www.pdnplu.com

P2H Ethernet Node 32 DO - Safe Power Connectivity



P2H Ethernet Node connection to SAFE Power PP / PM mode for valve control

The P2H Ethernet Node 32DO Auxiliary Power for valves can be supplied from an OSSD (Output Signal Switching Device) 24 VDC safe output power source in PP (plus plus) or PM (plus minus) configurations. The connection diagram below represents power option "A". For power option "L" valve driver number 4 power would be supplied from the logic pins of the connection selected (please reference the power pinout diagram).

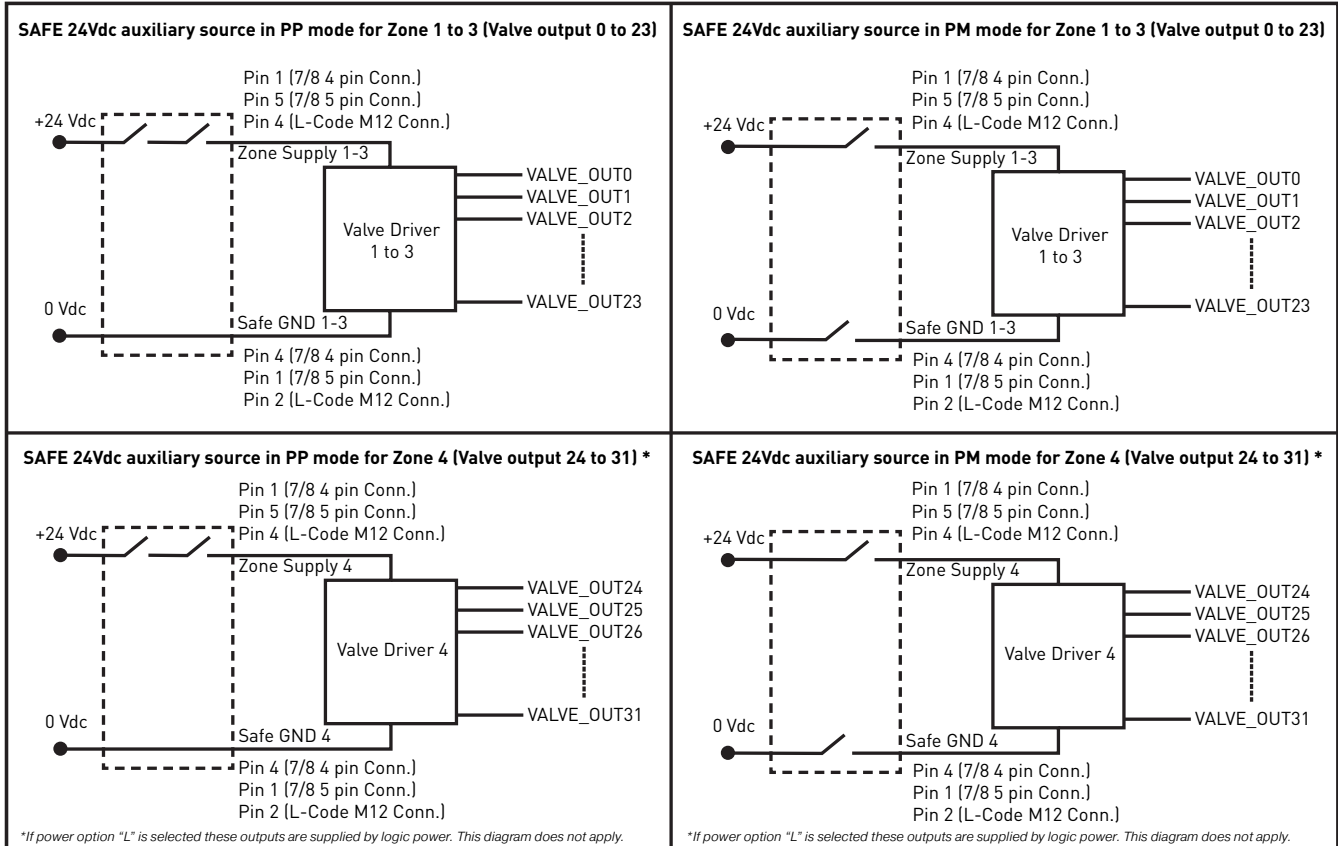

Note: Please check max. power available from the source. Refer to the ["Auxiliary power consumption calculation"](#) section.

* 7/8" logic power has no connection to internal P2H unit but does carryover to OUT 7/8" connector (for jumper logic power only). Logic power for P2H unit will be supplied from M12 (pin 1 & 3).



For inventory, lead times, and kit lookup, visit www.pdnplu.com

P2H Ethernet Node 32 DO - Auxiliary Power Consumption Calculation

The P2H Node 32DO auxiliary power consumption calculation depends on the combination of the valves selected and the number of coils used. The table below can be used for power consumption calculation by valve type and the number of each type used. Take note that there are two types of coils for sizes 1,2,3. An energy efficient coil and standard coil.

Valve Range	Number of Pilots Simultaneously powered	Power	Total
H ISO - 15407-2 - Sizes 02 & 01	_____	x 40 mA	= _____ mA
H ISO - 5599-2 - Sizes 1, 2 & 3 (Energy Efficiency Coils) *	_____	x 54 mA	= _____ mA
H ISO - 5599-2 - Sizes 1, 2 & 3 (Standard Coils) **	_____	x 133 mA	= _____ mA
		Total :	_____ mA

* F9 Valve Voltage Code

** B9 Valve Voltage Code

Power Supply Diagnostics

Power Supply Diagnostics through LED

The P2H Node 32DO monitors the logic and auxiliary power supply voltages and manages two levels of diagnostics: warning and error range. Status is indicated via LEDs located on the device. The range limits can be modified through parameter data. To restore default value (factory setting), refer to "Factory Reset Section" in the manual.

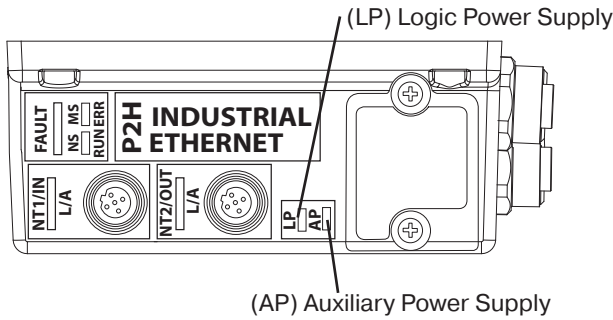

LP and AP (Green / Yellow) LEDs		
LED Status	Description	Troubleshooting
OFF	Logic and/or Aux lines not powered	Check power supply (see Power Supply section for pin assignments)
ON (Green)	Voltage in normal range	N/A
ON (Red)	Voltage in error range (too low or too high)	Check power supply (see Power Supply section for pin assignments)
Blinking (Red)	Voltage in warning range (out of normal range, not in error range)	Check power supply (see Power Supply section for pin assignments)
Blinking (Yellow)	Invalid rotary switch setting	Check rotary switch setting
Blinking (Red / Yellow)	Firmware version error or Completed "Reset to Factory" procedure	If switches setting different from "999" and no "Reset to Factory" performed via webpage, then contact technical support

LED function details:

- "Logic power" or "Aux power" error is active from 9.6 to 19.4 VDC or above 28.5 VDC
- When "Logic power error" or "Aux power error" is active, LED is solid red

Power Supply Diagnostics through Network and Process Data Mapping

Diagnostics are available in Process Input data (byte 0) to indicate whether Logic and Auxiliary voltages are within range. There is a warning range (normal operation with fault indication) and an error range (module enters Failsafe state).

The default warning range is set as 20.4 VDC < power supply < 26.4 VDC. These limits can be modified via acyclic data, objects # 11 and # 12. The error range is set as 19.4 VDC < power supply < 28.5 VDC. These limits cannot be modified.

The voltage measured by the module, both Logic and Auxiliary, can be accessed via acyclic data, in Object #4. The displayed value is in mV.

D

Subbase & Manual Valves

H Series Micro

Modulflex Series

H Series ISO

Network Connectivity

DX ISOMAX Series

Valvair II Series

P2H Ethernet Node 32 DO - Process Data mapping - Inputs

The following tables describes the input mapping for P2H Ethernet Node. The byte mapping order varies by protocol please reference the manual for specific byte order arrangement.

Channel Error – Input Mapping

Byte #	Input Bits								Description
	7	6	5	4	3	2	1	0	
1	EV07	EV06	EV05	EV04	EV03	EV02	EV01	EV00	Valve Error Data EVxx = Output on Valve range is 0 to 31
2	EV15	EV14	EV13	EV12	EV11	EV10	EV9	EV08	
3	EV23	EV22	EV21	EV20	EV19	EV18	EV17	EV16	
4	EV31	EV30	EV29	EV28	EV27	EV26	EV25	EV24	

Module Info Flags - Input Mapping

Byte #	Module Info Flags			
	Output Bits	Error Name	Error Description	
1	0	Heartbeat not toggling AUX 1	Heartbeat is currently not toggling	
	1	Heartbeat not toggling AUX 2		
	2	SPI COM Error AUX 1	Error in SPI Communication between AUX and Logic. Outputs are switched off	
	3	SPI COM Error AUX 2		
	4	SPI COM Lost AUX 1		
	1	5	SPI COM Lost AUX 2	Communication not possible. Outputs are switched off
		6	Output Interconnect Error	
7		SPI NP40 Error		
2	0	NP40 Version Error	Comm Module Version error. Outputs are switched off	
	1-7	Reserved	These bits will be always set as 0	

Module Error Input – Input Mapping

Byte #	Module Error Input		
	Output Bits	Error Name	Error Description
1	0	AUX Voltage Warning	Set if Auxiliary Voltage in warning range. Module keeps normal operation
	1	AUX Voltage Error	Auxiliary Voltage in Error range. Outputs are switched OFF
	2	Logic Voltage Warning	Set if Logic voltage is out of range for warning.
	3	Logic Voltage Error	Set if Logic voltage is out of range for error. Outputs are switched OFF
	4	Temperature Warning	Set if a temperature increase above warning levels is detected by the output drivers
	5	Output Driver Channel Error	Set if a major fault is detected at the output stage – solenoid short circuit. Outputs are switched OFF
	6	Module Error	Set if an internal communication error is active
2	7	Auxiliary Power Not Available	Auxiliary Power is off
	0 - 7	Reserved	These bits will be always set as 0

D
 Subbase & Manual Valves
 H Series Micro
 Moduflex Series
 H Series ISO
 Network Connectivity
 DX ISOMAX Series
 Valvair II Series



For inventory, lead times, and kit lookup, visit www.pdnplu.com

D185

Parker Hannifin Corporation
 Pneumatic Division
 Richland, Michigan
www.parker.com/pneumatics

P2H Ethernet Node 32 DO - Process Data mapping - Outputs

The following tables describes the input mapping for P2H Ethernet Node. The byte mapping order varies by protocol please reference the manual for specific byte order arrangement.

System Command – Output Mapping

Byte #	System Command Module								Description
	Output Bits								
	7	6	5	4	3	2	1	0	
1	System Command Value								One Byte that accepts the system command value see table below for values

Command Value	Command Name	Description
0X02	Store Switching Cycle Counters	When this command is executed, the current values of the switching cycle counters are stored into EEPROM. This command is intended to be used before powering off the device.
0X03	Store Diagnostic Log	When this command is executed, the diagnostic log is stored to the EEPROM.
0X04	Delete Diagnostic Log	Removes all diagnostic log entries in EEPROM (required by webpage).

Solenoids – Output Mapping

Byte #	Solenoid Module								Description
	Output Bits								
	7	6	5	4	3	2	1	0	
1	EV07	EV06	EV05	EV04	EV03	EV02	EV01	EV00	Valve Output Data EVxx -> Output on Valve range is 0 to 31
2	EV15	EV14	EV13	EV12	EV11	EV10	EV9	EV08	
3	EV23	EV22	EV21	EV20	EV19	EV18	EV17	EV16	
4	EV31	EV30	EV29	EV28	EV27	EV26	EV25	EV24	

D
Subbase & Manual Valves
H Series Micro
Modulflex Series
H Series ISO
Network Connectivity
DX ISOMAX Series
Valvair II Series



For inventory, lead times, and kit lookup, visit www.pdnplu.com

P2H Ethernet Node 32 DO - Solenoid Addressing

- The P2H Ethernet Network Node can support up to 32 addresses as shown
- Addresses 25-31 can be accessed using an Intermediate Air Supply with Electric Expansion
- Each address is one solenoid

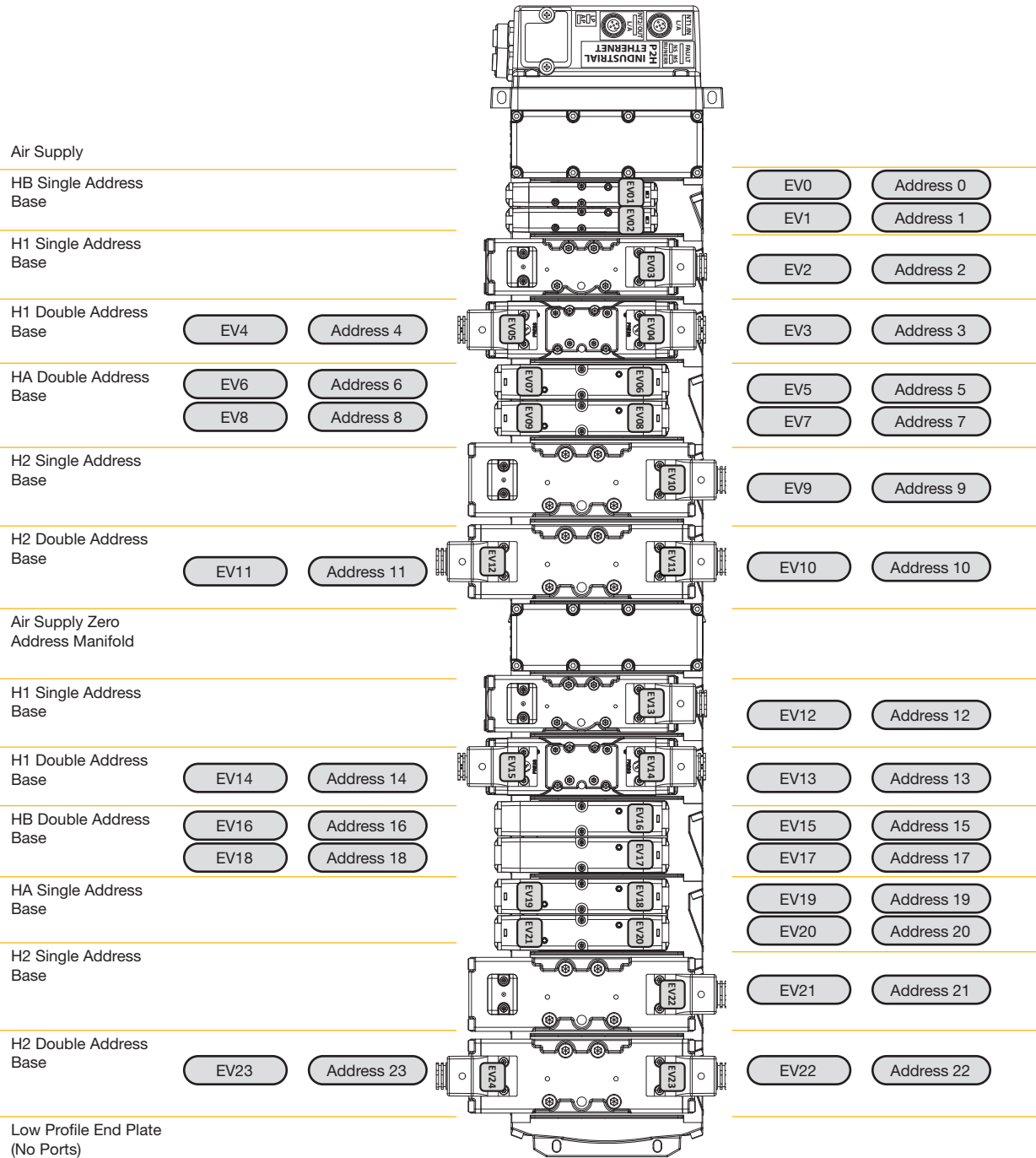

D

Subbase & Manual Valves

H Series Micro

Modulflex Series

H Series ISO

Network Connectivity

DX ISOMAX Series

Valvair II Series



For inventory, lead times, and kit lookup, visit www.pdnplu.com

D187

Parker Hannifin Corporation
 Pneumatic Division
 Richland, Michigan
www.parker.com/pneumatics

P2H Ethernet Node 32 DO - Technical Data

Mechanical Data

Housing Material	Housing /Enclosure: PBT with 33% GF and UL94-V0 Base Cover (plate): Aluminium 380
Enclosure rating	IP 65 (only when plugged-in and threaded-in)
Power Connectors	7/8" 4 pin or 7/8" 5 pin or L-Coded M12 5-pin male and female pin connector
Dimensions (L x B x H in mm)	226.6mm x 130.7mm x 55mm
Mounting type	Screw Mount
Ground strap attachment	M5
Weight	Approx. 1.3 kg

Electrical Data

Supply Voltage	24VDC (-15% to +20%)
Logic current at 24 V (V1)	Max Current 8A – Actual usage depends on configuration
Auxiliary current at 24 V (V2)	Max Current 12A – Actual usage depends on configuration

Valve Configuration

Compatible Valves	H Universal ISO Valves
-------------------	------------------------

Operating Conditions

Operating Temperature	0°C to 50°C
Storage Temperature	-25°C to 70°C
CE as per	IEC 61000-6-2 (Industrial Immunity) IEC 61000-6-4 (Industrial Emission)
Shock/Vibrations	IEC 60068-2-27:2008 IEC 60068-2-6:2007
Electrostatic Discharge	IEC 61000-4-2
Electrical Fast Transient/ Burst	IEC 61000-4-4
Surge Immunity	IEC 61000-4-5

D

Subbase & Manual Valves

H Series Micro

Modulflex Series

H Series ISO

Network Connectivity

DX ISOMAX Series

Valvair II Series



For inventory, lead times, and kit lookup, visit www.pdnplu.com

D188

Parker Hannifin Corporation
Pneumatic Division
Richland, Michigan
www.parker.com/pneumatics

P2H Ethernet Node 32 DO - H Series ISO Valves

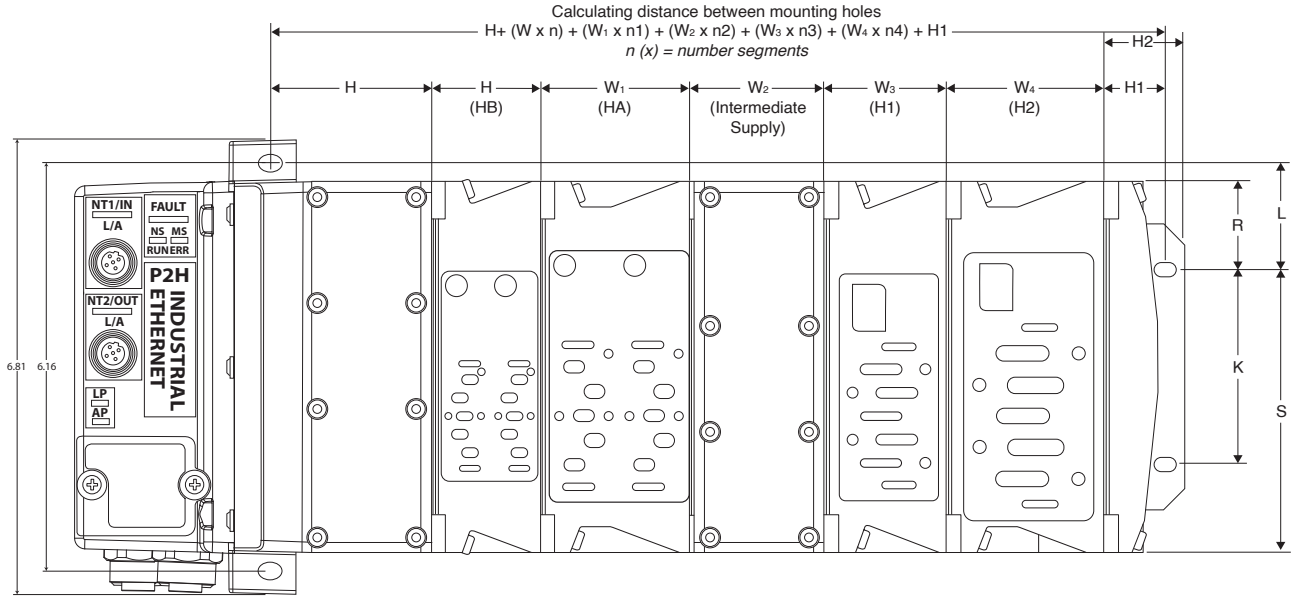

n (x) = number of segments

A	B	C	D	E	F	G	H	H ₁	H ₂	J	K	L
4.42 (112.3)	2.64 (67.1)	2.46 (62.5)	1.17 (29.7)	.55 (14)	9.32 (236.7)	1.51 (38.4)	2.36 (59.9)	.9 (22.9)	1.22 (31)	1.55 (39.4)	2.95 (74.9)	1.6 (40.6)
M	O	P	Q	R	S	T	W	W ₁	W ₂	W ₃	W ₄	
8.91 (226.3)	5.61 (142.5)	6.86 (174.2)	6.18 (157)	1.33 (33.8)	4.28 (108.7)	7.14 (181.4)	1.63 (41.4)	2.28 (57.9)	2.03 (51.6)	1.82 (46.2)	2.39 (60.7)	

Inches (mm)

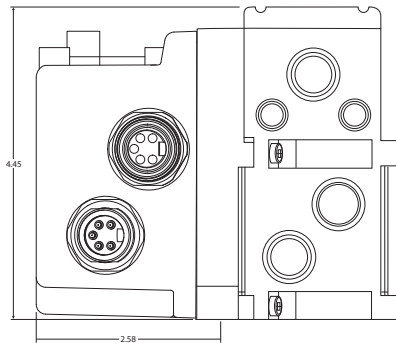

D

**Subbase & Manual
Valves**

**H Series
Micro**

**Moduflex
Series**

**H Series
ISO**

**Network
Connectivity**

**DX ISOMAX
Series**

**Valvair II
Series**



For inventory, lead times, and kit lookup, visit www.pdnplu.com

D189

Parker Hannifin Corporation
Pneumatic Division
Richland, Michigan
www.parker.com/pneumatics

D
Subbase & Manual Valves
H Series Micro
Moduflex Series
H Series ISO
Network Connectivity
DXISOMAX Series
Valvair II Series



For inventory, lead times, and kit lookup, visit www.pdnplu.com

D190

Parker Hannifin Corporation
Pneumatic Division
Richland, Michigan
www.parker.com/pneumatics

Features

PCH Network Portal

Features

- Industrial Ethernet Communication
- Truly Configurable I/O
- Feature Rich Webserver
- Built-In Technician
- 3 Available Module Variants, 4 ports each
- Bluetooth Connectivity
- Flexible power connectors allowing daisy chain
- Certified to IP65 ingress protection
- Weld splatter resistant housing material
- Welding Noise Immune
- Safe Power Capable
- Built-in configurable IO-Link Master Ports

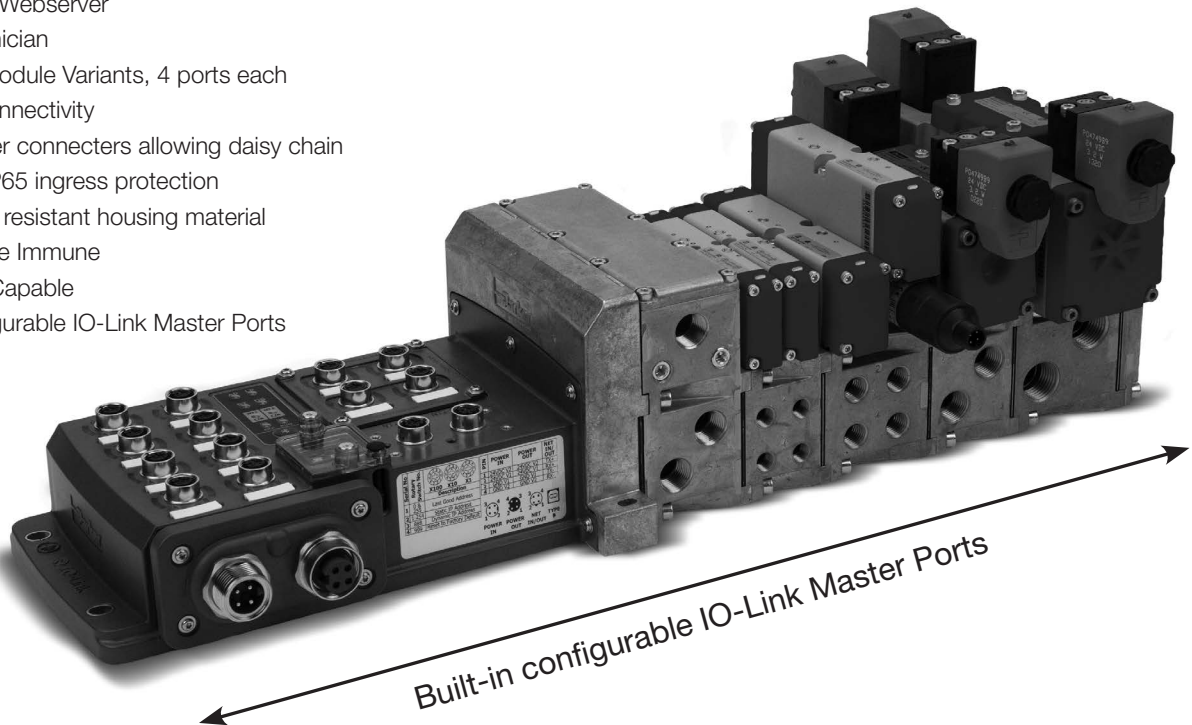

The PCH Network Portal redefines and revolutionizes decentralized machine I/O's architecture. The PCH Network Portal was engineered to support industrial ethernet protocols and the open protocol IO-Link with configurable inputs/outputs with true PNP/ NPN circuitry switching on each port for easy machine design changes. This integrated configurability gives the user flexibility in designing custom I/O architecture on the fly.

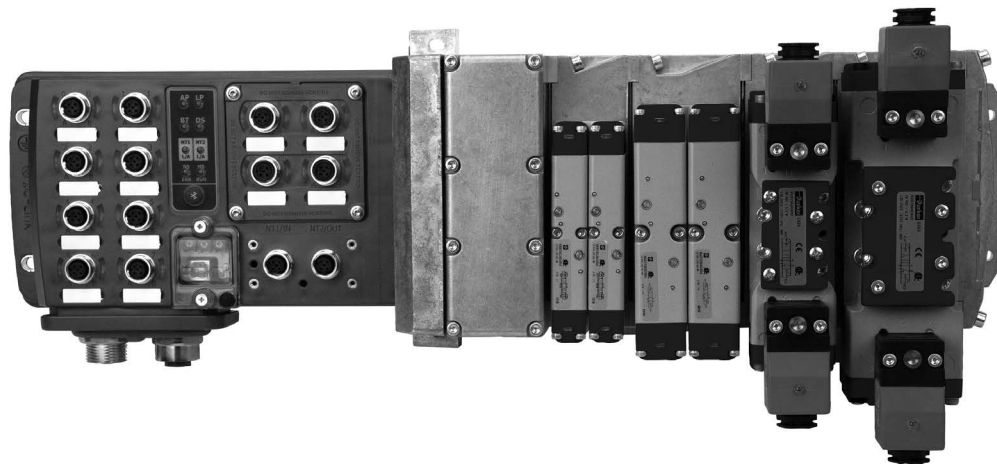

EtherNet/IP™

PROFI
INDUSTRIAL ETHERNET
NET

EtherCAT®

Modbus
TCP/IP

The PCH Network Portal can be assembled to Parker's H ISO Universal Manifold Platform, giving you access to a wide variety of low ranges all on one manifold.



For inventory, lead times, and kit lookup, visit www.pdnplu.com

D191

Parker Hannifin Corporation
Pneumatic Division
Richland, Michigan
www.parker.com/pneumatics

D

Subbase & Manual Valves

H Series Micro

Moduflex Series

H Series ISO

Network Connectivity

DX ISOMAX Series

Valvair II Series

Features

Intuitive Interfaces

Modern factories recognize that plant floor architecture is an important structural part of machine design that can make a real difference in managing costs for future changes, integrations and expansions. The PCH Network Portal design team lived in this environment, therefore intuitive interfaces and complete modularity was the heart of PCH Network Portal design concepts.

As with all Cyber Physical Systems (CPS), intuitive interfaces are the backbone of simplicity in application. The PCH Network Portal offers several means of intuitive and embedded interfaces to shorten commission time.

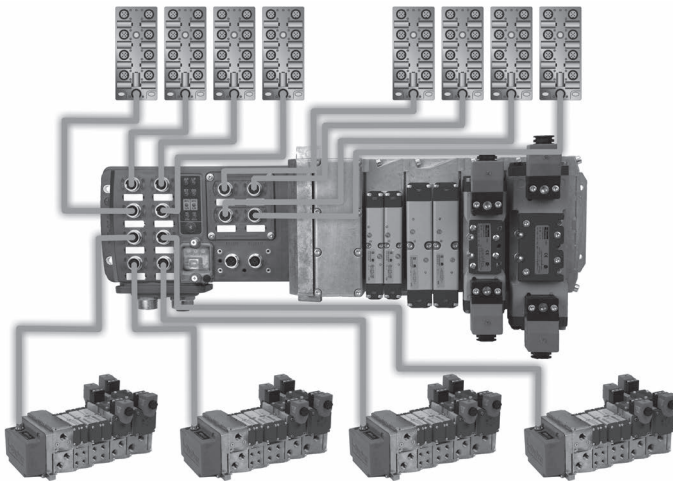
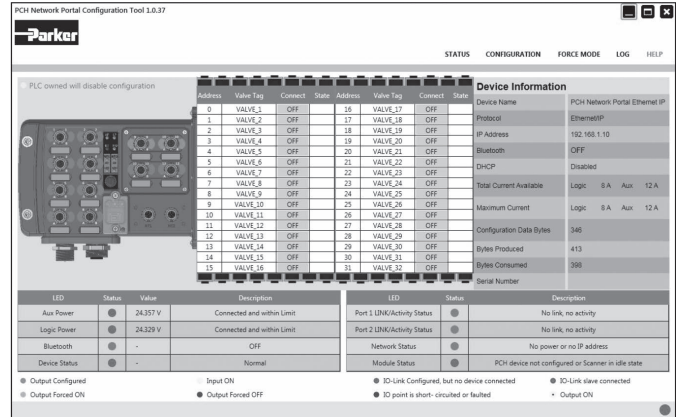

Value Redefined

The PCH Network Portal minimizes machine costs by redefining the traditional process of connectivity within a single footprint that provides multiple configurations. The flexibility of configurable I/O combined with built-in IO-Link master ports revolutionizes machine design and can save thousands of dollars at the design phase which typically accounts for 30-40% of overall costs. Changes can be made to the system with easy software reconfiguration of ports eliminating the need for additional hardware or time consuming programming.



Can't access the PLC? No Problem!

With meticulously designed embedded configuration tools, the PCH Network Portal can serve as your **virtual technician** to make problems easy to troubleshoot. A laptop, tablet or phone can access usable prognostic/diagnostic data and time stamped event logs to make accessing data and commissioning your machine simple. Once you've finished your configuration, the device's configuration profile can be downloaded and easily uploaded to other PCH Network Portals on your machine.

Configure via:

- Bluetooth App via phone or tablet
- Bluetooth connection via PC
- Integrated Webpage via ethernet connection
- Stand-a-lone "PCH Portal Configuration Tool" software via USB-B

Safety Foot Note:
Bluetooth application cannot turn on outputs if a PLC where present and in control. The application cannot override the PLC at any time.

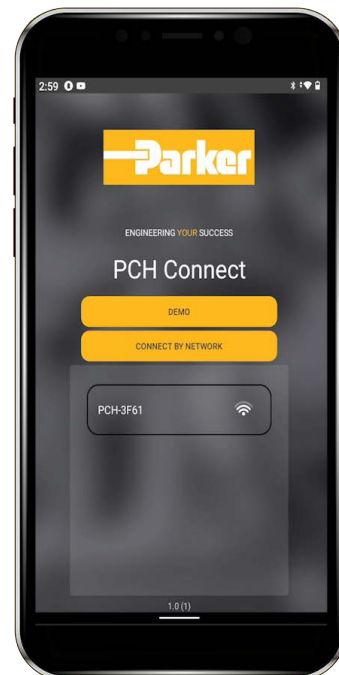

D
 Subbase & Manual Valves
 H Series Micro
 Modutex Series
 H Series ISO
 Network Connectivity
 DX ISOMAX Series
 Valvair-II Series



For inventory, lead times, and kit lookup, visit www.pdnplu.com

Features

Truly Configurable I/O

Configurable I/O means last minute design changes are now simple. Each PCH Network Portal is offered with three selectable modules that make up twelve configurable ports. All modules can be configured IO-Link A, IO-Link B or dual configurable I/O ports with true PNP/NPN circuitry switching on each port providing easy point and click changes on individual pins to customize a setup. Last minute design changes to the machine require minimal effort and no additional software or hardware. The ability to customize the machine design is no longer limited by the product.

H Series ISO & Network Connectivity PCH Network Portal

Port Config

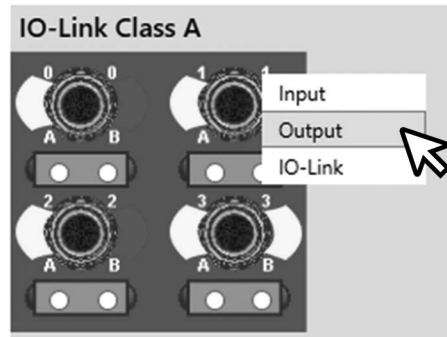

Tools Designed for Productivity

When a line stops and needs a reset you are often left wondering why. The root cause can seem a mystery and often stems back to over voltage or other power issues caused by the plant floor. Working with the PCH Network Portal is like having your own built-in technician. Rolling 40 errors, warnings and events are time and date stamped allowing you to spend time on what matters - running the facility. Let PCH Network Portal give you the detail so time can be better utilized elsewhere.

Built-In Technician

When using the 'PCH Portal Configuration Tool' your built-in technician comes to life with easy to follow screens for readouts, adjustments, and settings. Configuring the PCH Network Portal to the network is easy. Fast and storable configurations combined with embedded smart diagnostic and prognostic tools like built-in debounce times and up/down counters translate to quick change-over and short downtime. Further problems are easy to spot with the rolling 40 error, warnings, and events log which are time stamped. No more guessing at what went wrong in plant. Commissioning and troubleshooting a tool can even be done remotely from outside the work cell via the device's secure and lockable Bluetooth connectivity.

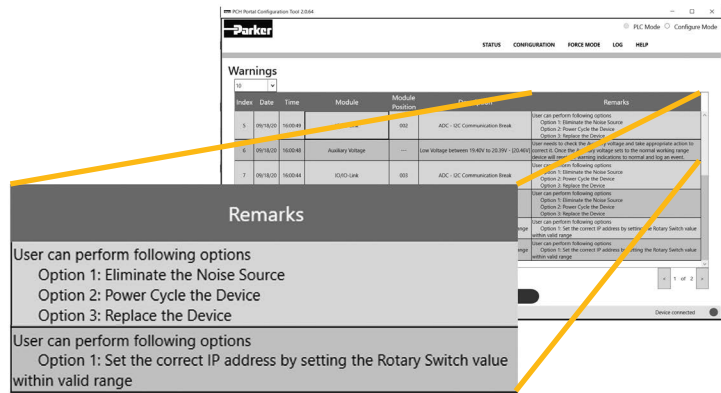

D
 Subbase & Manual Valves
 H Series Micro
 Moduflex Series
 H Series ISO
 Network Connectivity
 DX ISOMAX Series
 Valvair II Series



For inventory, lead times, and kit lookup, visit www.pdnplu.com

D193

Parker Hannifin Corporation
 Pneumatic Division
 Richland, Michigan
www.parker.com/pneumatics

Value Redefined

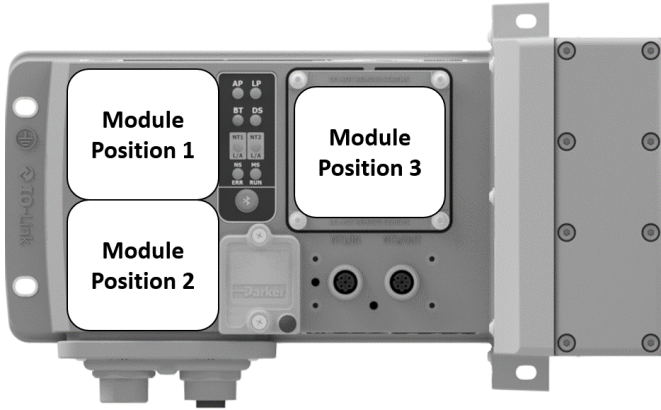

What are Module Positions?

- The PCH Network Portal is split into 3 Module Positions
- Each Module Position can accept different Module Variants to meet the application needs
- Populating a Module Position with an I/O Module Variant gives the PCH Network Portal 4 configurable M12 ports

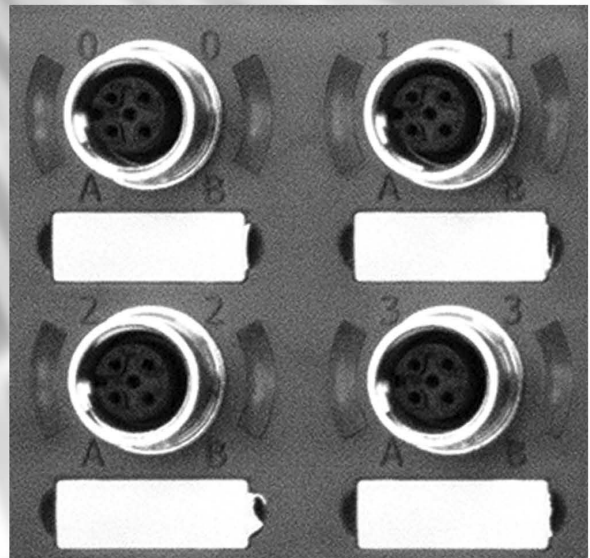
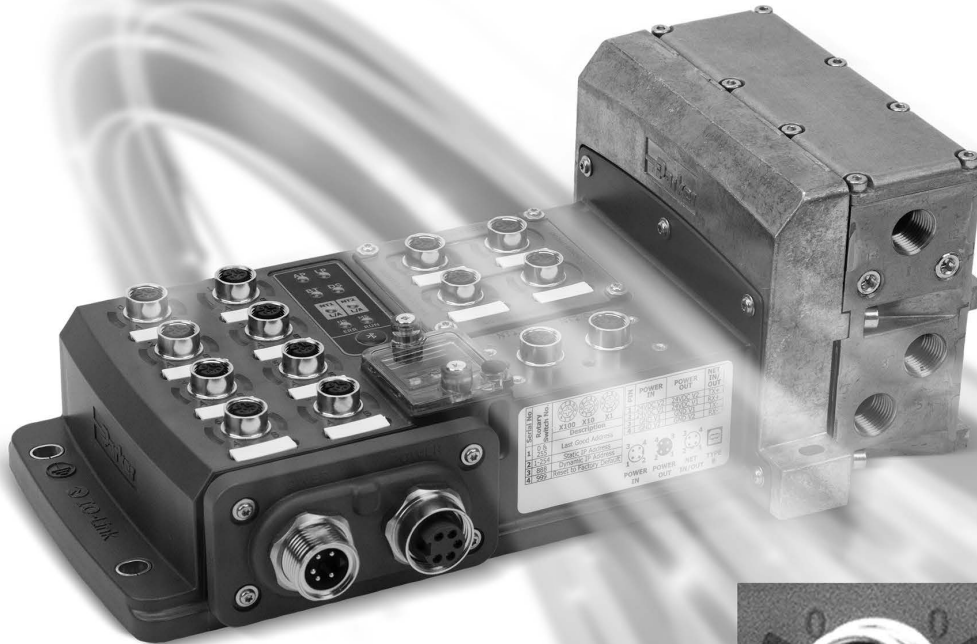

What is a Module Variant?

- 3 Module Variant are proposed offering each different capabilities (see details of Modules Variant A, B or C in next pages)
- A Module Variant offers 4 configurable M12 ports
- Depending on the Module Variant A, B or C selected, each M12 port can be individually configured differently between a variety of different behaviors

For Example

- With the Module Position 1 populated with Module Variant A, each M12 port can be individually configured as either IO-Link Class A Master or 2 Digital Inputs or 2 Digital Outputs
- A summary of the Module Variant offerings is on page D179

D	Subbase & Manual Valves
H Series Micro	Modulflex Series
H Series ISO	Network Connectivity
DX ISOMAX Series	Valvair II Series



For inventory, lead times, and kit lookup, visit www.pdnplu.com

Features

PCH Network Portal

Module Variants

Module
A

What is a Module Variant?

- The PCH Network Portal has 3 available Module Positions. Each module position can be populated with three different Module Variants
- Each Module Position can accept all module variants

Port Behavior

- Each port is capable of the following behavior listed below
- Through software, the user can click and change how the port behaves on the fly
- The A Module Variant gives the user access to IO-Link Class A Master ports

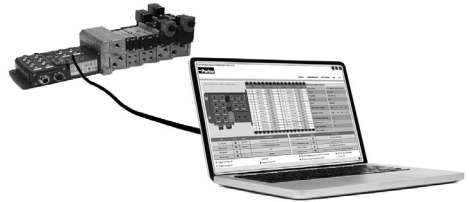

Possible Port Behavior

- IO-Link, Class A Master or
2 x Digital Inputs or
2 x Digital Outputs*
- IO-Link, Class A Master or
2 x Digital Inputs or
2 x Digital Outputs*

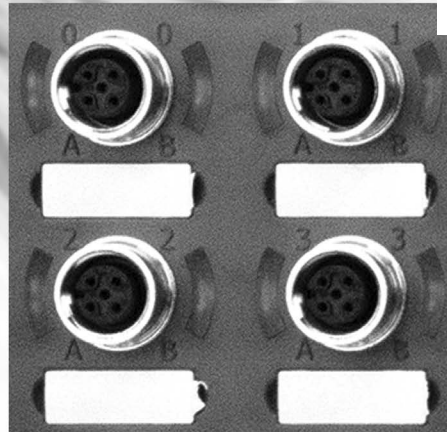

- IO-Link, Class A Master or
2 x Digital Inputs or
2 x Digital Outputs*
- IO-Link, Class A Master or
2 x Digital Inputs or
2 x Digital Outputs*

*Digital Output draws current from logic power

Port Behavior

- Each port's behavior can differ from one another
- For example, the user can select the behavior listed below through software (shown below)

- IO-Link, Class A Master or
2 x Digital Inputs
- IO-Link, Class A Master or
2 x Digital Inputs or
2 x Digital Outputs

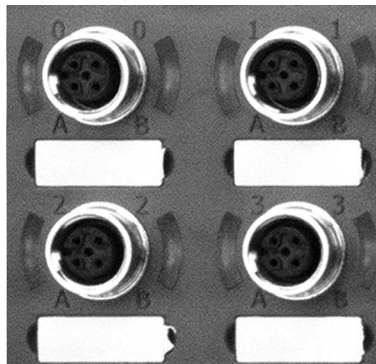

- IO-Link, Class A Master**
- IO-Link, Class A Master or
2 x Digital Inputs or
2 x Digital Outputs

D

Subbase & Manual Valves

H Series Micro

Moduflex Series

H Series ISO

Network Connectivity

DX ISOMAX Series

Valvair II Series



For inventory, lead times, and kit lookup, visit www.pdnplu.com

D195

Parker Hannifin Corporation
Pneumatic Division
Richland, Michigan
www.parker.com/pneumatics

Features

PCH Network Portal

Module Variants

Module

B

What is a Module Variant?

- The PCH Network Portal has 3 available Module Positions. Each module position can be populated with three different Module Variants
- Each Module Position can accept all module variants

Port Behavior

- Each port is capable of the following behavior listed below
- Through software, the user can click and change how the port behaves on the fly
- The B Module Variant gives the user access to IO-Link Class B Master ports



Possible Port Behavior

- IO-Link, Class B Master or
1 x Digital Input or
1 x Digital Output*
- IO-Link, Class B Master or
1 x Digital Input or
1 x Digital Output*

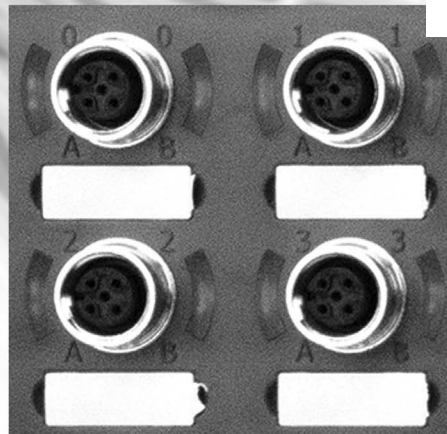

- IO-Link, Class B Master or
1 x Digital Input or
1 x Digital Output*
- IO-Link, Class B Master or
1 x Digital Input or
1 x Digital Output*

*Digital Output draws current from logic power

Port Behavior

- Each port's behavior can differ from one another
- For example, the user can select the behavior listed below through software (shown below)

- IO-Link, Class B Master or
1 x Digital Input
- IO-Link, Class B Master or
1 x Digital Input or
1 x Digital Output

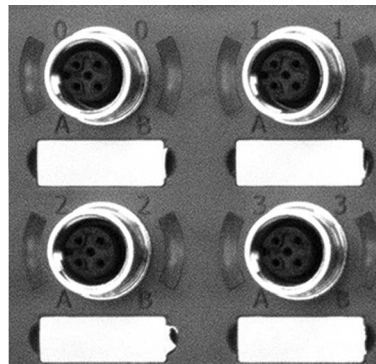

- IO-Link, Class B Master**
- IO-Link, Class B Master or
1 x Digital Input or
1 x Digital Output
- IO-Link, Class B Master or
1 x Digital Input or
1 x Digital Output

D

Subbase & Manual Valves

H Series Micro

Modulflex Series

H Series ISO

Network Connectivity

DX ISOMAX Series

Valvair-II Series



For inventory, lead times, and kit lookup, visit www.pdnplu.com

Features

PCH Network Portal

Module Variants

Module



What is a Module Variant?

- The PCH Network Portal has 3 available Module Positions. Each module position can be populated with three different Module Variants
- Each Module Position can accept all module variants

Port Behavior

- Each port is capable of the following behavior listed below
- Through software, the user can click and change how the port behaves on the fly
- The C Module Variant gives the user access to IO-Link Class B Master ports and fixed high current outputs

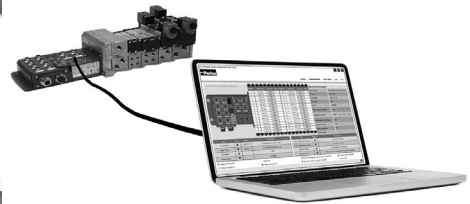

Possible Port Behavior

2 x Digital Outputs, 500 mA each, Fixed ¥

IO-Link, Class B Master or
1 x Digital Input or
1 x Digital Output*

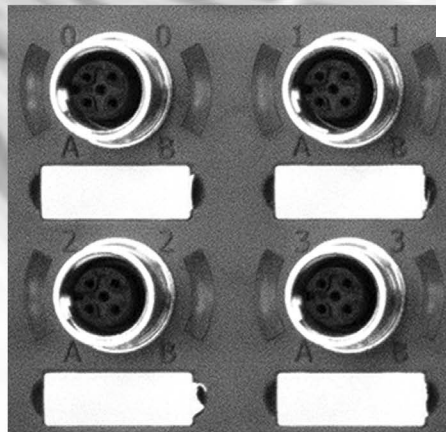

2 x Digital Outputs, 500 mA each, Fixed ¥

IO-Link, Class B Master or
1 x Digital Input or
1 x Digital Output*

¥ Digital Outputs draw current from auxiliary power
* Digital Output draws current from logic power

Port Behavior

- Each port's behavior can differ from one another
- For example, the user can select the behavior listed below through software (shown below)

2 x Digital Outputs, 500 mA each, Fixed

IO-Link, Class B Master or
1 x Digital Input or
1 x Digital Output

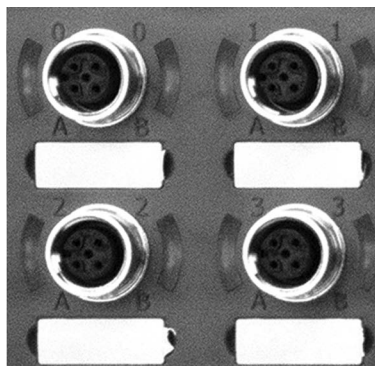

2 x Digital Outputs, 500 mA each, Fixed

IO-Link, Class B Master
1 x Digital Input or
1 x Digital Output



For inventory, lead times, and kit lookup, visit www.pdnplu.com

D

Subbase & Manual Valves

H Series Micro

Moduflex Series

H Series ISO

Network Connectivity

DX ISOMAX Series

Valvair II Series

I/O Module Combinations

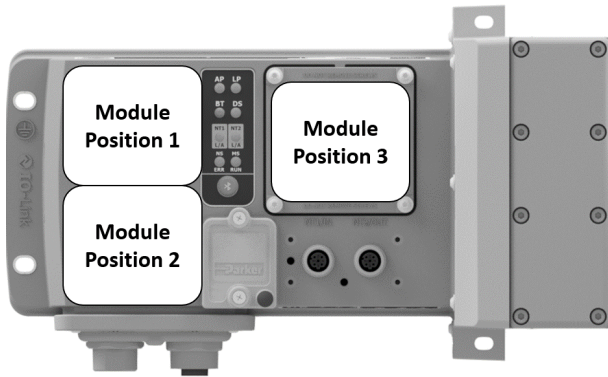

- The PCH Network Portal gives true port flexibility
- The PCH Network Portal can be ordered with 3 available module variants
- Each module variant has 4, M12 Ports
- Each module variants can be chosen in any module position
- Each port is individually software configurable
- A blanking plate is available for Module Position 3
- **Important:** Once Module Variants are selected on the PCH Network Portal, they cannot be changed in the field

Before it comes through your door
Select which Module Variant you want in each Module Position



After it comes through your door
Truly Configurable I/O - Select port behavior from listed options

D

Subbase & Manual Valves

H Series Micro

Modulflex Series

H Series ISO

Network Connectivity

DX ISOMAX Series

Valvair II Series

Module Variants

Module A		<ul style="list-style-type: none"> • IO-Link, Class A Master OR • 2 Inputs, PNP/NPN OR • 2 Outputs, 250 mA ea 		<ul style="list-style-type: none"> • IO-Link, Class A Master OR • 2 Inputs, PNP/NPN OR • 2 Outputs, 250 mA ea
		<ul style="list-style-type: none"> • IO-Link, Class A Master OR • 2 Inputs, PNP/NPN OR • 2 Outputs, 250 mA ea 		<ul style="list-style-type: none"> • IO-Link, Class A Master OR • 2 Inputs, PNP/NPN OR • 2 Outputs, 250 mA ea
Module B		<ul style="list-style-type: none"> • IO-Link, Class B Master OR • 1 Input, PNP/NPN OR • 1 Output, 250 mA ea 		<ul style="list-style-type: none"> • IO-Link, Class B Master OR • 1 Input, PNP/NPN OR • 1 Output, 250 mA ea
		<ul style="list-style-type: none"> • IO-Link, Class B Master OR • 1 Input, PNP/NPN OR • 1 Output, 250 mA ea 		<ul style="list-style-type: none"> • IO-Link, Class B Master OR • 1 Input, PNP/NPN OR • 1 Output, 250 mA ea
Module C		<ul style="list-style-type: none"> • 2 Outputs, 500 mA ea 		<ul style="list-style-type: none"> • 2 Outputs, 500 mA ea
		<ul style="list-style-type: none"> • IO-Link, Class B Master OR • 1 Input, PNP/NPN OR • 1 Output, 250 mA ea 		<ul style="list-style-type: none"> • IO-Link, Class B Master OR • 1 Input, PNP/NPN OR • 1 Output, 250 mA ea
Module N	Blank Cover, No Ports, Only available in Position 3			



For inventory, lead times, and kit lookup, visit www.pdnplu.com

I/O Module Combinations

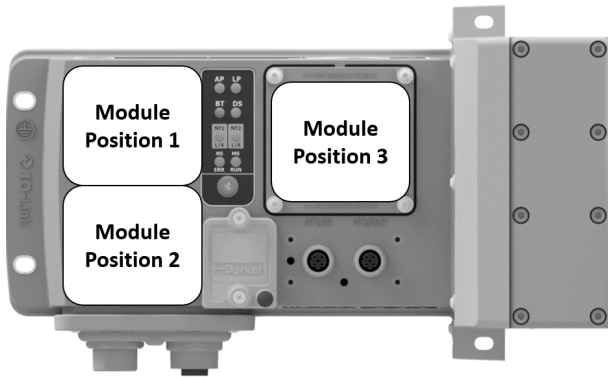

- Below are 16 standard module combinations
- For simplicity, similar combinations of modules are consolidated into one combination



Example Model Structure



Below are the standard module configurations

Refer to page 183 for full product Module Structure.

Order Code	Module Position 1	Module Position 2	Module Position 3
AAA	A	A	A
AAB	A	A	B
AAC	A	A	C
AAN	A	A	N
ABB	A	B	B
ABC	A	B	C
ABN	A	B	N
ACC	A	C	C
ACN	A	C	N
BBB	B	B	B
BBC	B	B	C
BBN	B	B	N
BCC	B	C	C
BCN	B	C	N
CCC	C	C	C
CCN	C	C	N

For any module configurations not listed, consult factory.

D
Subbase & Manual Valves
H Series Micro
Moduflex Series
H Series ISO
Network Connectivity
DX ISOMAX Series
Valvair II Series



For inventory, lead times, and kit lookup, visit www.pdnplu.com

Power Options

- The PCH Network Portal has 4 available power connectors
- There are two power schemes that can be achieved detailed below
- Any I/O ports using AUX power and any attached H ISO Universal manifold valves draw power from the AUX power pins of the power connector

Consumption @ 24 VDC

AUX power max consumption 12A
 Logic power max consumption 8A

Total possible passthrough for AUX line and Logic 20A

Any power left over can be passed on to other devices on the network



Power Connector *	
4-pin power in/out with 1 safe power capable zone	P4
5-pin power in/out with 1 safe power capable zone	P5
4-pin power in/in with 2 safe power zones	S4
5-pin power in/in with 2 safe power zones	S5

Power Scheme 1

- All 32 addresses are controlled in the same power zone
- Safety zoning is possible for valve solenoids and, with the H ISO Universal valves, pneumatic pressure
- Power zone is safe power capable
- Available in 4 or 5-pin 7/8" power connectors

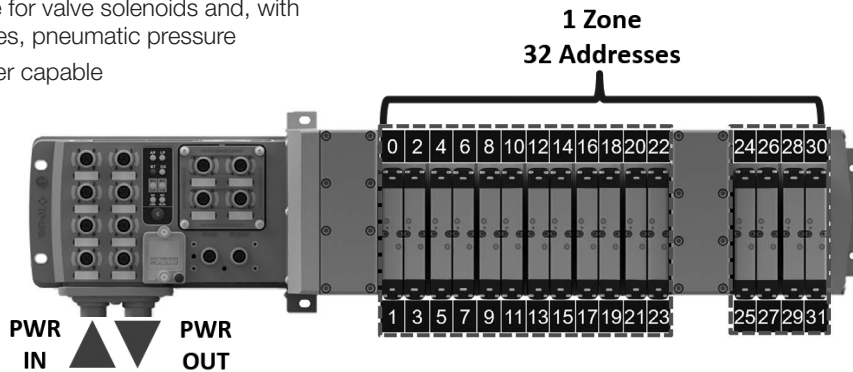

Power Scheme 2

- The power connector separates the valve power
- Each zone has an isolated safe ground pin so each can be powered by a SAFE 24 VDC auxiliary source in PP or PM mode
- Available in 4 or 5 pin 7/8" power connectors

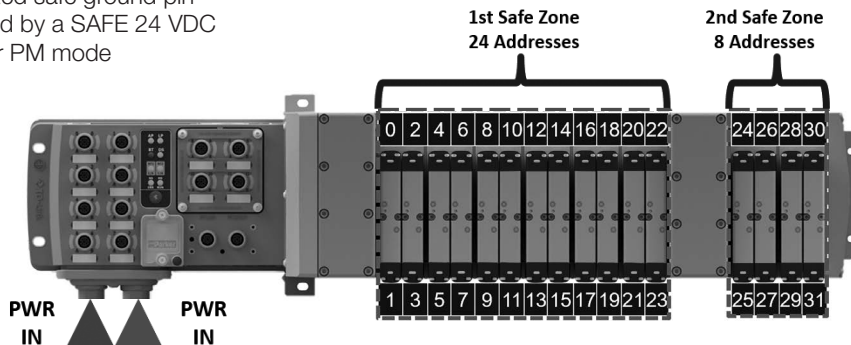

D
 Subbase & Manual Valves
 H Series Micro
 Modulflex Series
 H Series ISO
 Network Connectivity
 DX ISOMAX Series
 Valvair II Series



For inventory, lead times, and kit lookup, visit www.pdnplu.com

D200

Parker Hannifin Corporation
 Pneumatic Division
 Richland, Michigan
www.parker.com/pneumatics

Common Part Numbers

Popular Module Combinations

- Listed below are popular module configurations
- For full model number structure, please refer to next page

EtherNet/IP™

Popular Part Number Configurations						
Pilot Type	Thread Type	Module Position			Power Connector	End Plate Part Number
		1	2	3		
Internal	NPT	A	A	A	4-pin power IN/OUT with 1 safe power capable zone	PSHU20P300PEAAA0-P4
Internal	NPT	A	A	B	4-pin power IN/OUT with 1 safe power capable zone	PSHU20P300PEAAB0-P4
Internal	NPT	A	B	C	4-pin power IN/OUT with 1 safe power capable zone	PSHU20P300PEABC0-P4
Internal	NPT	A	A	N	4-pin power IN/OUT with 1 safe power capable zone	PSHU20P300PEAAN0-P4
Internal	NPT	A	A	A	5-pin power IN/OUT with 1 safe power capable zone	PSHU20P300PEAAA0-P5
Internal	NPT	A	A	B	5-pin power IN/OUT with 1 safe power capable zone	PSHU20P300PEAAB0-P5
Internal	NPT	A	A	C	5-pin power IN/OUT with 1 safe power capable zone	PSHU20P300PEAAC0-P5
Internal	NPT	A	A	N	5-pin power IN/OUT with 1 safe power capable zone	PSHU20P300PEAAN0-P5
Internal	NPT	A	A	A	4-pin power IN/IN with 2 safe power zones	PSHU20P300PEAAA0-S4
Internal	NPT	A	A	N	5-pin power IN/IN with 2 safe power zones	PSHU20P300PEAAN0-S5



Popular Part Number Configurations						
Pilot Type	Thread Type	Module Position			Power Connector	End Plate Part Number
		1	2	3		
Internal	NPT	A	A	A	5-pin power IN/OUT with 1 safe power capable zone	PSHU20P300PNAAA0-P5
Internal	NPT	A	A	B	5-pin power IN/OUT with 1 safe power capable zone	PSHU20P300PNAB0-P5
Internal	NPT	A	B	C	5-pin power IN/OUT with 1 safe power capable zone	PSHU20P300PNABC0-P5
Internal	NPT	A	A	N	5-pin power IN/OUT with 1 safe power capable zone	PSHU20P300PNAAN0-P5
Internal	NPT	A	A	A	5-pin power IN/OUT with 1 safe power capable zone	PSHU20P300PNAAA0-P5
Internal	NPT	A	A	B	5-pin power IN/IN with 2 safe power zones	PSHU20P300PNAB0-S5
Internal	NPT	A	A	C	5-pin power IN/IN with 2 safe power zones	PSHU20P300PNAAC0-S5
Internal	NPT	A	A	N	5-pin power IN/IN with 2 safe power zones	PSHU20P300PNAAN0-S5
Internal	NPT	A	A	A	5-pin power IN/IN with 2 safe power zones	PSHU20P300PNAAA0-S5
Internal	NPT	A	A	N	5-pin power IN/IN with 2 safe power zones	PSHU20P300PNAAN0-S5

EtherCAT®

Popular Part Number Configurations						
Pilot Type	Thread Type	Module Position			Power Connector	End Plate Part Number
		1	2	3		
Internal	NPT	A	A	A	4-pin power IN/OUT with 1 safe power capable zone	PSHU20P300PTAAA0-P4
Internal	NPT	A	A	B	4-pin power IN/OUT with 1 safe power capable zone	PSHU20P300PTAAB0-P4
Internal	NPT	A	B	C	4-pin power IN/OUT with 1 safe power capable zone	PSHU20P300PTABC0-P4
Internal	NPT	A	A	N	4-pin power IN/OUT with 1 safe power capable zone	PSHU20P300PTAAN0-P4
Internal	NPT	A	A	A	5-pin power IN/OUT with 1 safe power capable zone	PSHU20P300PTAAA0-P5
Internal	NPT	A	A	B	5-pin power IN/OUT with 1 safe power capable zone	PSHU20P300PTAAB0-P5
Internal	NPT	A	A	C	5-pin power IN/OUT with 1 safe power capable zone	PSHU20P300PTAAC0-P5
Internal	NPT	A	A	N	5-pin power IN/OUT with 1 safe power capable zone	PSHU20P300PTAAN0-P5
Internal	NPT	A	A	A	4-pin power IN/IN with 2 safe power zones	PSHU20P300PTAAA0-S4
Internal	NPT	A	A	N	5-pin power IN/IN with 2 safe power zones	PSHU20P300PTAAN0-S5



For inventory, lead times, and kit lookup, visit www.pdnplu.com

D201

Parker Hannifin Corporation
Pneumatic Division
Richland, Michigan
www.parker.com/pneumatics

D

Subbase & Manual Valves

H Series Micro

Moduflex Series

H Series ISO

Network Connectivity

DX ISOMAX Series

Valvair II Series

Ordering Information

End Plate Kit – Universal Plug-in

The PCH Network Portal is ordered as an endplate kit. This includes the PCH Network Portal, left hand air supply module, and right hand end plate.

For fully assembled manifold Add-A-Fold part number, reference page D88



PSHU20 P3 0 0 P E AAA 0 - P4

Valve Type	
Plug-in (Internal pilot)	PSHU20
Plug-in (External pilot)	PSHU2X

Thread Type	
NPT	0
BSPP "G"	1

Network Connections	
EtherNet/IP™	E
EtherCAT	T
PROFINET	N
Modbus TCP	M

Power Connector	
4-pin power IN/OUT with 1 safe power capable zone	P4
5-pin power IN/OUT with 1 safe power capable zone	P5
4-pin power IN/IN with 2 safe power zones	S4
5-pin power IN/IN with 2 safe power zones	S5

Right Hand End Plate Type / Thread Size	
Low profile (no ports)	0
1/2 Exhaust and inlet port	1
3/4 Exhaust and inlet port	2
H3 Transition plate and end plate (electrical pass through for plug-in valves only)	3
H3 Transition plate and end plate (expansion to 25th address for plug-in valves only)	4

Module Combinations		
Module Position 1	Module Position 2	Module Position 3
A	A	A
A	A	B
A	A	C
A	A	N
A	B	B
A	B	C
A	B	N
A	C	C
A	C	N
B	B	B
B	B	C
B	B	N
B	C	C
B	C	N
C	C	C
C	C	N

For any module configurations not listed, consult factory.

D	Subbase & Manual Valves
	H Series Micro
	Modulflex Series
	H Series ISO
	Network Connectivity
	DX ISOMAX Series
	Valvair II Series

Most popular.



For inventory, lead times, and kit lookup, visit www.pdnplu.com

Mechanical Data

Housing Material	Housing /Enclosure: PBT with 33% GF and UL94-V0 Base Cover (plate): Aluminum 380
Enclosure rating	IP 65 (only when plugged-in and threaded-in)
Power Connectors	7/8" 4 or 5 pin male and female pin connector
Input ports/ Output ports	M12, A-coded (12 x female)
Dimensions (L x B x H in mm)	226.6mm x 130.7mm x 55mm
Mounting type	Screw Mount
Ground strap attachment	M5
Weight	Approx. 1.3 kg

Operating Conditions

Operating Temperature	0°C to 50°C
Storage Temperature	-25°C to 70°C
CE as per	IEC 61000-6-2 (Industrial Immunity)
	IEC 61000-6-4 (Industrial Emission)
Shock/Vibrations	IEC 60068-2-27:2008
	IEC 60068-2-6:2007
Electrostatic Discharge	IEC 61000-4-2
Electrical Fast Transient/ Burst	IEC 61000-4-4
Surge Immunity	IEC 61000-4-5

Electrical Data

Supply Voltage	24VDC (-15% to +20%)
Logic current at 24 V (V1)	Max Current 8A – Actual usage depends on configuration
Auxiliary current at 24 V (V2)	Max Current 12A – Actual usage depends on configuration

Valve Configuration

Compatible Valves	H Universal ISO Valves
Available addresses	24 addresses, 32 addresses with H Universal Extension Slice



For inventory, lead times, and kit lookup, visit www.pdnplu.com

D203

Parker Hannifin Corporation
Pneumatic Division
Richland, Michigan
www.parker.com/pneumatics

D

Subbase & Manual Valves

H Series Micro

Moduflex Series

H Series ISO

Network Connectivity

DX ISOMAX Series

Valvair II Series





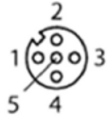
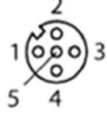
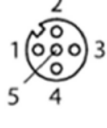







I/O Port Pin Outs

- The PCH Network Portal uses threaded M12 Ports for I/O Connections
- All configurable ports are configurable through software at any time

Module Variant	Connector	Pin No.	Function
A *Applies to ports 1-4 of this module		1	+24V, 500mA VLOG (V1)
		2	Input (PNP or NPN) / Output +24V, 250 mA (V1)
		3	GND (V1)
		4	IO-Link/Input (PNP or NPN) / Output +24V, 250mA (V1)
		5	Not Connected
B *Applies to ports 1-4 of this module		1	+24V, 250mA VLOG (V1)
		2	+24V, 1.2A VAUX (V2)
		3	GND (V1)
		4	IO-Link/Input (PNP or NPN) / Output +24V, 250mA (V1)
		5	GND (V2)
C *Applies to ports 1-2 of this module		1	Not Connected
		2	Output +24VAUX (V2), 500mA
		3	GND (V2)
		4	Output +24VAUX (V2), 500mA
		5	Not Connected
D *Applies to ports 3-4 of this module		1	+24V, 250mA VLOG (V1)
		2	+24V, 1.2A VAUX (V2)
		3	GND (V1)
		4	IO-Link/Input (PNP or NPN) / Output +24V, 250mA (V1)
		5	GND (V2)

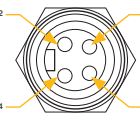
Power Conector Pin Outs

- The PCH Network Portal uses 7/8" ports for its left IN and right OUT or IN power connectors.
- Any power configuration below can be ordered
- For AIDA power connector, consult factory

	Left Power Connector: Power IN				Right Power Connector: Power OUT			
	Connector	Pin No.	Function	Description	Connector	Pin No.	Function	Description
P4 		1	+24 V	V2 (VAUX), 12A		1	+24 V	V2 (VAUX), 3.8A
		2	+24 V	V1 (VLOG), 8A		2	+24 V	V1 (VLOG), 1.28A
		3	0 V	GND V1 (VLOG)		3	0 V	GND V1 (VLOG)
		4	0 V	GND V2 (VAUX)		4	0 V	GND V2 (VAUX)
		5	0 V	GND V2 (VAUX)		5	0 V	GND V2 (AUX)
P5 		1	0 V	GND V2 (VAUX)		1	0 V	GND V2 (AUX)
		2	0 V	GND V1 (VLOG)		2	0 V	GND V1 (VLOG)
		3	Protective Earth	Protective Earth		3	Protective Earth	Protective Earth
		4	+24 V	V1 (VLOG), 8A		4	+24 V	V1 (VLOG)
		5	+24 V	V2 (VAUX), 12A		5	+24 V	V2 (VAUX)
S4 		1	+24 V	V2 (VAUX), 12A		1	+24 V	V2 (VAUX), 3.8A
		2	+24 V	V1 (VLOG), 8A		2	+24 V	V1 (VAUX), 1.28A
		3	0 V	GND V1 (VLOG)		3	0 V	Safe GND 1-3*
		4	0 V	GND V2 (VAUX)		4	0 V	Safe GND 4*
		5	0 V	GND V2 (VAUX)		5	+24 V	V2 (VAUX), 3.8A
S5 		1	0 V	GND V2 (VAUX)		1	+24 V	V2 (VAUX), 3.8A
		2	0 V	GND V1 (VLOG)		2	+24 V	V1 (VAUX), 1.28A
		3	Protective Earth	Protective Earth		3	Protective Earth	Protective Earth
		4	+24 V	V1 (VLOG), 8A		4	0 V	Safe GND 1-3*
		5	+24 V	V2 (VAUX), 12A		5	0 V	Safe GND 4*

*"Safe GND 1-3" refers to solenoid addresses 0-23 and "Safe GND 4" refers to solenoid addresses 24-31



For inventory, lead times, and kit lookup, visit www.pdnplu.com

D204

Parker Hannifin Corporation
 Pneumatic Division
 Richland, Michigan
www.parker.com/pneumatics

Subbase & Manual Valves
 H Series Micro
 Modulflex Series
 H Series ISO
 Network Connectivity
 DX ISOMAX Series
 Valvair II Series

Solenoid Addressing

- The PCH Network Portal can use the following H ISO Universal Valves:
 - ISO 15407-2 – sizes 02 & 01
 - ISO 5599-2 – sizes 1, 2 & 3
- The PCH Network Portal can support up to 32 addresses as shown
- The data map and PCH Tool refers to each address with a Valve_X designator. Each Valve_X designator is as shown.
- Addresses 25-31 can be accessed using an Intermediate Air Supply with Electric Expansion
- Each address is one solenoid

Air Supply

HB Single Address Manifold

H1 Single Address Manifold

H1 Double Address Manifold

HA Double Address Manifold

H2 Single Address Manifold

H2 Double Address Manifold

Air Supply Zero Address Manifold

H1 Single Address Manifold

H1 Double Address Manifold

HB Double Address Manifold

HA Single Address Manifold

H2 Single Address Manifold

H2 Double Address Manifold

Low Profile End Plate (No Ports)

EV4 Address 4

EV6 Address 6

EV8 Address 8

EV11 Address 11

EV14 Address 14

EV16 Address 16

EV18 Address 18

EV23 Address 23

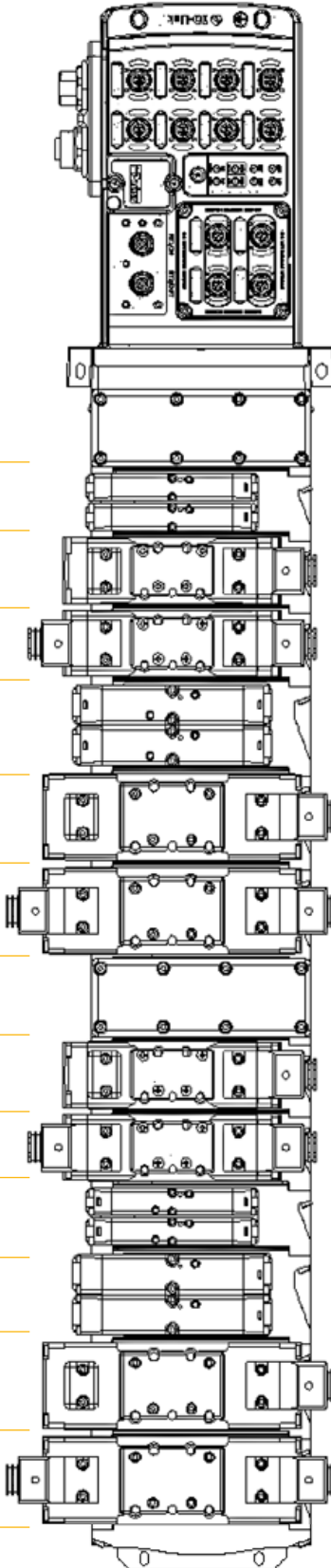

EV0 Address 0

EV1 Address 1

EV2 Address 2

EV3 Address 3

EV5 Address 5

EV7 Address 7

EV9 Address 9

EV10 Address 10

EV12 Address 12

EV13 Address 13

EV15 Address 15

EV17 Address 17

EV19 Address 19

EV20 Address 20

EV21 Address 21

EV22 Address 22

D

Subbase & Manual Valves

H Series Micro

Moduflex Series

H Series ISO

Network Connectivity

DX ISOMAX Series

Valvair II Series



For inventory, lead times, and kit lookup, visit www.pdnplu.com

D205

Parker Hannifin Corporation
 Pneumatic Division
 Richland, Michigan
www.parker.com/pneumatics

PCH Network Portal with H Series ISO Valves

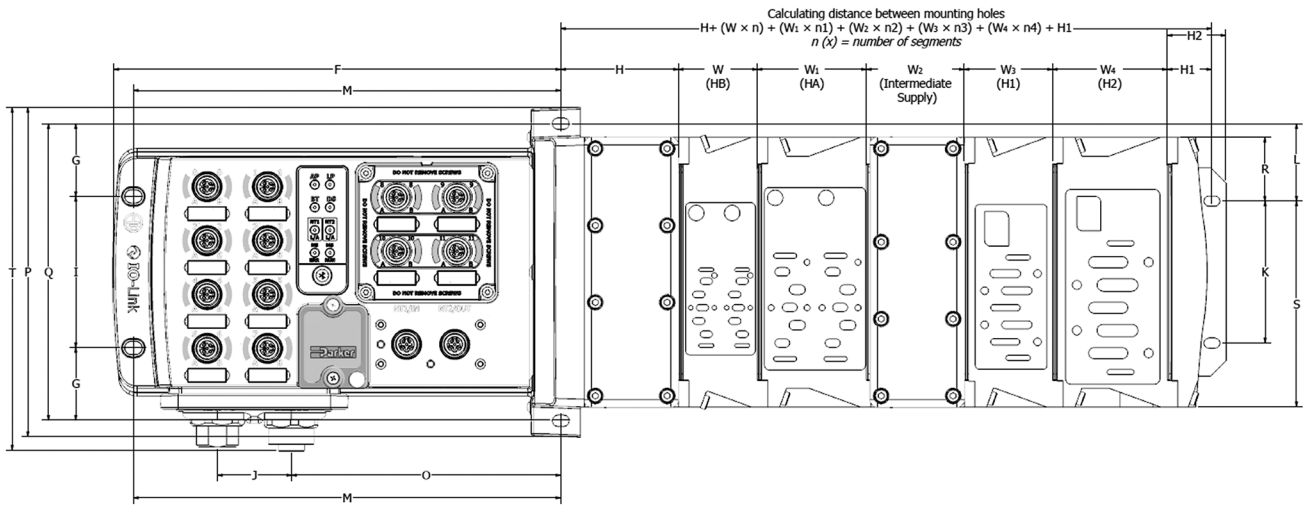

n (x) = number of segments

A	B	C	D	E	F	G	H	H ₁	H ₂	J	K	L
4.42 (112.3)	2.64 (67.1)	2.46 (62.5)	1.17 (29.7)	.55 (14)	9.32 (236.7)	1.51 (38.4)	2.36 (59.9)	.9 (22.9)	1.22 (31)	1.55 (39.4)	2.95 (74.9)	1.6 (40.6)
M	O	P	Q	R	S	T	W	W ₁	W ₂	W ₃	W ₄	
8.91 (226.3)	5.61 (142.5)	6.86 (174.2)	6.18 (157)	1.33 (33.8)	4.28 (108.7)	7.14 (181.4)	1.63 (41.4)	2.28 (57.9)	2.03 (51.6)	1.82 (46.2)	2.39 (60.7)	

Inches (mm)

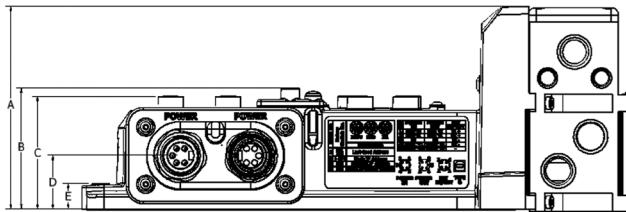

D
Subbase & Manual Valves
H Series Micro
Modulflex Series
H Series ISO
Network Connectivity
DX ISOMAX Series
Valvair II Series



For inventory, lead times, and kit lookup, visit www.pdnplu.com

D206

Parker Hannifin Corporation
Pneumatic Division
Richland, Michigan
www.parker.com/pneumatics

Product Support

- The PCH Network Portal Product Landing page can be accessed at the following:



www.parker.com/pdn/PCHPortal

- The PCH Network Portal support material can be accessed at the following:



www.parker.com/pdn/networkconnectivity

- The PCH Connect - Bluetooth App



User Manuals

- The PCH Network Portal User Manuals can be accessed at the following website. Click on QR code for hyperlink.

EtherNet/IP™ EtherNet/IP™ User Manual



Profinet User Manual



EtherCAT® EtherCAT User Manual



Modbus User Manual



For more information on IO-link
www.io-link.com



For inventory, lead times, and kit lookup, visit www.pdnplu.com

Features

The Turk Network Portal

Turk Network Portal has four major components:

- **Valve Driver Module** provide control for either 16 or 32 solenoids on a manifold
- **I/O Modules** provide the field interface and system-interface circuitry
- **Communication Modules** provide the network-interface circuitry
- **Power Distribution Module** provide 5 additional power inputs to the Turk system

Turk Features

- Highly modular design (4pt – 16pt modularity)
- Broad application coverage
- Expandable 4 port Class A IO-Link master
- Channel-level diagnostics (LED and electronic)
- Channel-level alarm and annunciation (electronic)
- Channel-level open-wire detection with electronic feedback
- Channel-level short-circuit detection with electronic feedback
- Horizontal and vertical mounting without derating
- 5g vibration
- Electronic and mechanical keying
- Robust backplane design
- Quick-disconnects for I/O and network connectivity
- Built-in panel grounding
- Color-coded module labels
- UL, cCSAus, and CE certifications (as marked)
- Highly reliable structural integrity
- Optical isolation between field and system circuits

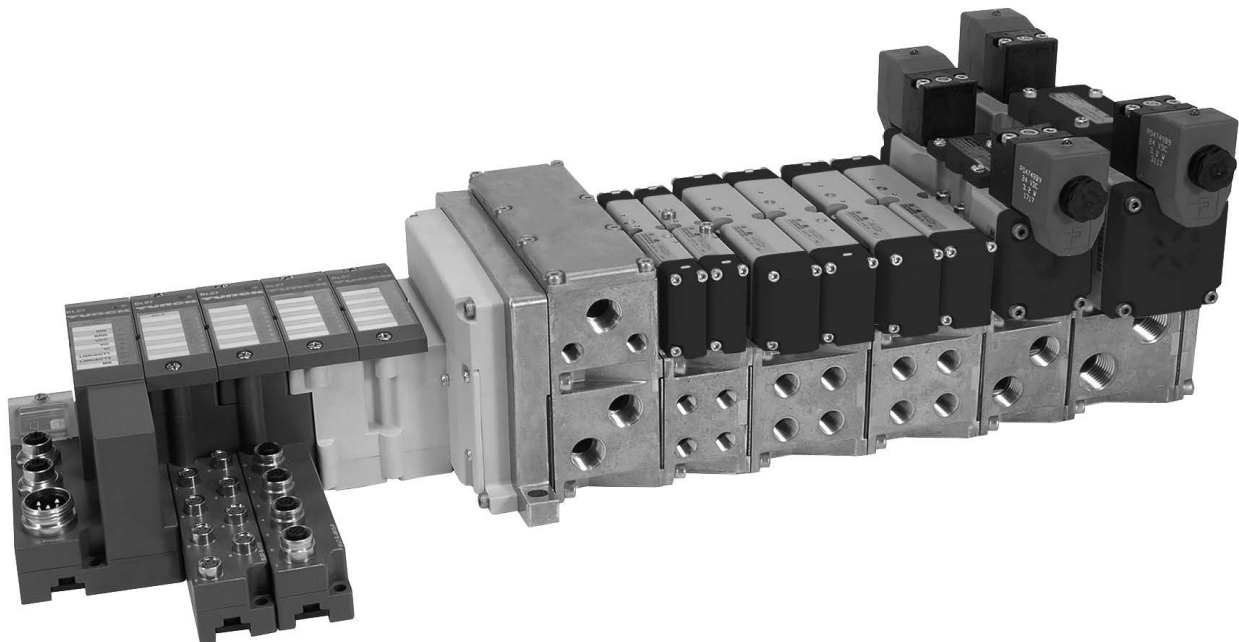

D

Subbase & Manual
ValvesH Series
MicroModulflex
SeriesH Series
ISONetwork
ConnectivityDX ISOMAX
SeriesValvair-II
Series

For inventory, lead times, and kit lookup, visit www.pdnplu.com

D208

Parker Hannifin Corporation
Pneumatic Division
Richland, Michigan
www.parker.com/pneumatics

Turk Network Portal

- A complete network communication offering for all H Series ISO and H Series Micro valves
- CSA, cULus and CE certifications (as marked)

I/O Configuration

- Centralized Turk Network Portal
- Pneumatics and I/O are in close proximity with one another
- M23, 12-Pin or 19-Pin output extension to an additional H Series valve manifold
- I/O density per module = 4, 8 or 16

EtherNet/IP™

DeviceNet

PROFI®
 PROCESS FIELD BUS

PROFI®
 INDUSTRIAL ETHERNET

Modbus/TCP™

CANopen

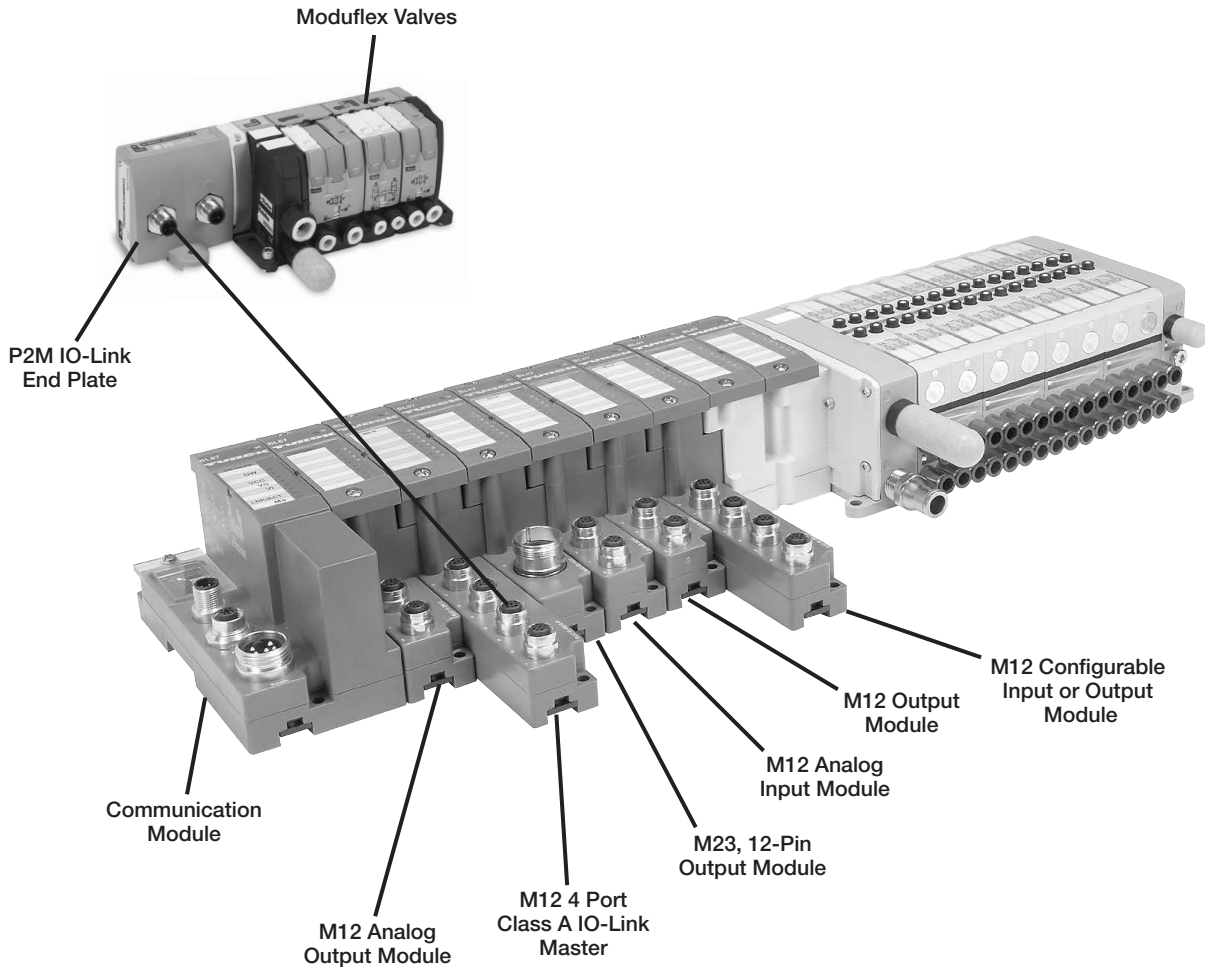

Configure / Program any module with RS232, or directly through Ethernet for any module with an Ethernet physical layer.



D

Subbase & Manual Valves

H Series Micro

Moduflex Series

H Series ISO

Network Connectivity

DX ISOMAX Series

Valvair II Series



Turk Network Portal

- A complete network communication offering for all H Series ISO and H Series Micro valves.
- CSA, cCSAus and CE certifications (as marked).

I/O Configuration

- Complete control of all I/O and valves with stand alone control
- Additional I/O and valves connected over DeviceNet with BL Remote Subnet
- BL Remote connection to P2M and Turk DeviceNet equipped communication modules
- I/O density per module = 4, 8 or 16

EtherNet/IP™

DeviceNet

PROFIBUS
PROCESS FIELD BUS

PROFIBUS
INDUSTRIAL ETHERNET

Modbus/TCP™

CANopen

D
Subbase & Manual Valves
H Series Micro
Modulflex Series
H Series ISO
Network Connectivity
DX ISOMAX Series
Valvair II Series

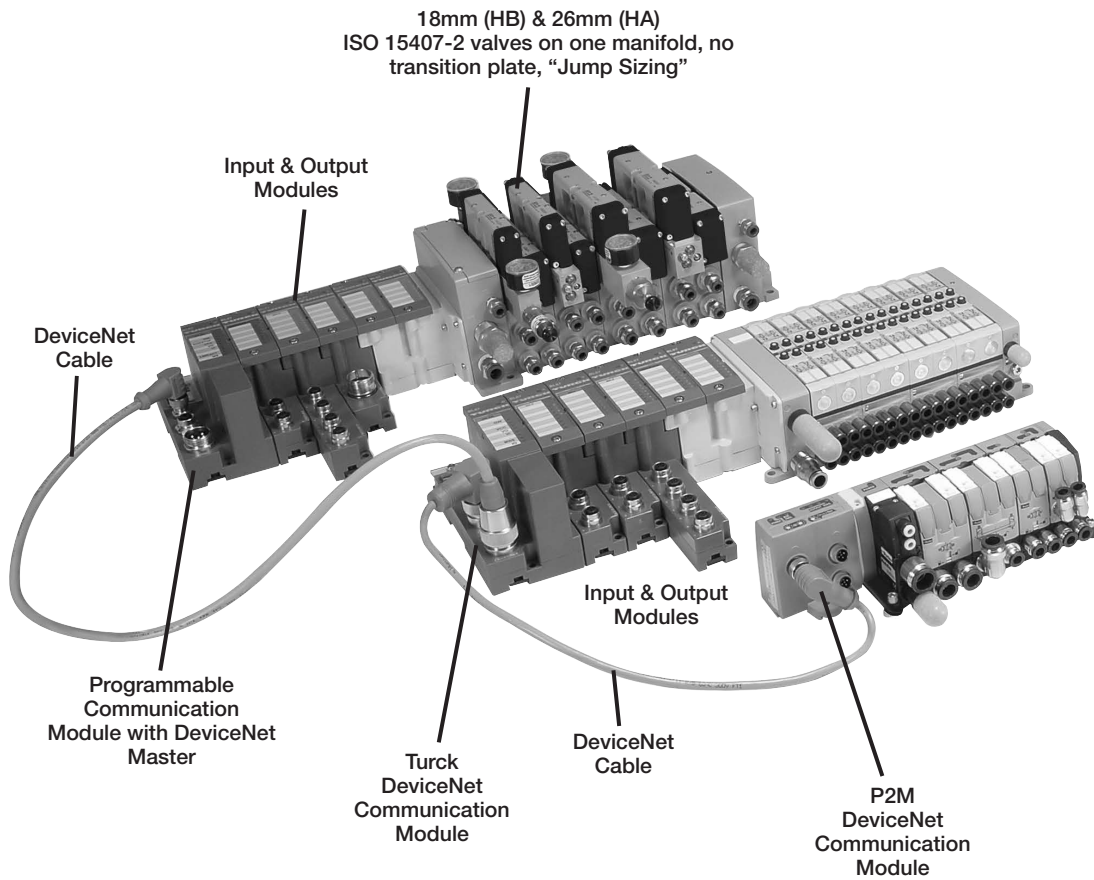

For inventory, lead times, and kit lookup, visit www.pdnplu.com

D210

Parker Hannifin Corporation
 Pneumatic Division
 Richland, Michigan
www.parker.com/pneumatics

Communications Module

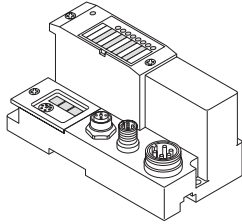

BL67 communication modules are the heart of a BL67 station. They are designed to connect the modular nodes to the higher level network (PROFIBUS-DP, DeviceNet, CANopen, Ethernet).

All BL67 electronic modules communicate over the internal module bus with the communication modules. The communication module structures the data and sends them clustered via network nodes to the higher control system.

This way all I/O modules can be configured independently of the system.

Electronic Module

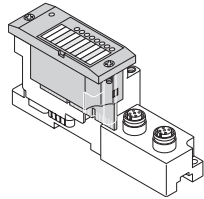

BL67 electronic modules are inserted into the passive base modules from above and then simply affixed with two screws. Maintenance is extremely simplified due to the separation of connection level and module electronics.

Moreover, flexibility is enhanced because the base modules provide different types of connectors. Voltage supply for the electronic modules is either provided via the communication modules or a Power Extender module. Power Extender modules can be used to create galvanically isolated potential groups.

Base Module

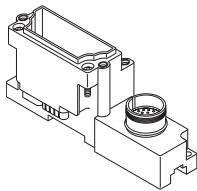

BL67 base modules are aligned one by one to the right of the communication module and are tightened each with two screws, either with the communication modules or with the previous module. A DIN rail is not required. This way a compact and stable unit is created which can be mounted directly on the machine.

The base modules serve for connection of the field devices and are available with different connection types (M8, M12, M23 and 7/8).

A BL67 system can be extended to a total length of 1 m, comprising of a communication module for PROFIBUS-DP, DeviceNet / CANopen or Ethernet and a maximum of 32 modules.

System supply: The power supply for the BL67 system is either derived separately for Profibus-DP and Ethernet communication modules or directly from the DeviceNet / CANopen cable for the DeviceNet / CANopen communication module.

Power Extender modules can be inserted anywhere in the BL67 station. They provide isolated field voltage for the I/O modules mounted to their right.

Thus Power Extender modules can also be used to create different potential groups.

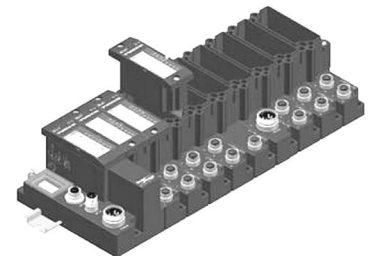

Maximum System Extension

Module type		PROFIBUS		DeviceNet		CANopen		ModbusTCP		EtherNet/IP		PROFIBUS NET	
		Number of chan.	Number of mod.	Number of chan.	Number of mod.	Number of chan.	Number of mod.	Number of chan.	Number of mod.	Number of chan.	Number of mod.	Number of chan.	Number of mod.
Digital inputs	4 DI	128	32	128	32	128	32	128	32	128	32	128	32
	8 DI	256	32	256	32	256	32	256	32	256	32	256	32
Digital outputs	4 DO	128	32	128	32	128	32	128	32	128	32	128	32
	8 DO	256	32	256	32	256	32	256	32	256	32	256	32
	16 DO	512	32	512	32	512	32	512	32	512	32	512	32
Analog inputs	2AI	64	32	64	32	64	32	64	32	64	32	64	32
	4AI	112	28	124	31	124	31	128	32	128	32	128	32
	2 AI-PT	56	28	64	32	64	32	64	32	64	32	64	32
	2 AI-TC	64	32	64	32	64	32	64	32	64	32	64	32
Analog outputs	2 AO-I	38	19	64	32	64	32	64	32	64	32	64	32
	2 AO-V	38	19	50	25	50	25	50	25	50	25	50	25



For inventory, lead times, and kit lookup, visit www.pdnplu.com

D211

Parker Hannifin Corporation
 Pneumatic Division
 Richland, Michigan
www.parker.com/pneumatics

D

Subbase & Manual Valves

H Series Micro

Modulflex Series

H Series ISO

Network Connectivity

DX ISOMAX Series

Valvair II Series

BL67-GW-DN

DeviceNet Communication
 Module with Power Over
 the Network



7/8 Mini bus in wiring,
 view into male connector

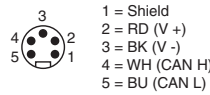

7/8 Mini bus out wiring,
 view into female connector

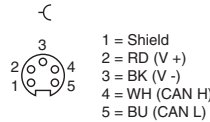

Turck Network Portal with up to 256 inputs, outputs, and 32 solenoids per H Series Micro or H Series ISO manifold. Digital inputs / outputs, analog inputs / outputs, serial interface, and counter modules are available. DeviceNet communication speeds selectable between 120, 250, 500 kbps, and CANopen communication speeds are selectable between 10 kbps up to 1 Mbps. Addressing for either module can be selected via rotary switches or set through software.

With the Power over the Network feature, it is only necessary to connect one cable to the communication module. For networks requiring additional power, a Bus Power Tee can be installed to combine separate network and power feeds into the communication module. See the Cables and Cordsets section for additional information.

BL67-GW-DPV1

PROFIBUS Communication
 Module



M12 B-code bus out Wiring,
 view into female connector

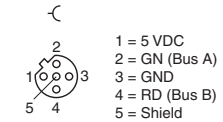

M12 B-code bus In Wiring,
 view into male connector

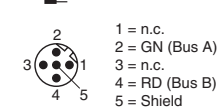

7/8 Mini Power in wiring,
 view into male connector

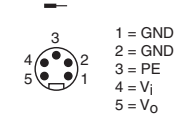

Turck Network Portal with up to 256 inputs, outputs, and 32 solenoids per H Series Micro or H Series ISO manifold. Digital inputs / outputs, analog inputs / outputs, serial interface, and counter modules are available. PROFIBUS communication speeds are selectable between 9.6 kbps up to 12 Mbps, and addressing can be selected via rotary switches or set through software.

BL67-GW-CO

CANopen Communication
 Module



M12 A-code bus out Wiring,
 view into female connector

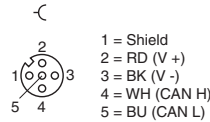

M12 A-code bus In Wiring,
 view into male connector

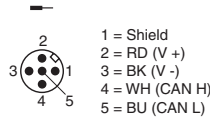

7/8 Mini Power in wiring,
 view into male connector

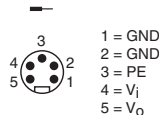

Turck Network Portal with up to 256 inputs, outputs, and 32 solenoids per H Series Micro or H Series ISO manifold. Digital inputs / outputs, analog inputs / outputs, serial interface, and counter modules are available. CANopen communication speeds are selectable between 10 kbps up to 1 Mbps, and addressing can be selected via rotary switches or set through software.

BL67-GW-EN

Modbus/TCP, EtherNet/IP™, and PROFINET

BL67-GW-EN-PN

PROFINET Communication Module



M12 D-code
 Ethernet in Wiring,
 view into female connector

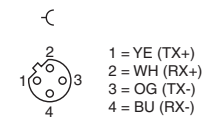

7/8 Mini Power in wiring,
 view into male connector

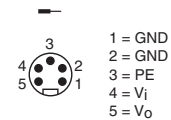

Turck Network Portal with up to 256 inputs, outputs, and 32 solenoids per H Series Micro or H Series ISO manifold. Digital inputs / outputs, analog inputs / outputs, serial interface, and counter modules are available. Communication speeds of 10/100 Mbps, and addressing can be selected via rotary switches, BOOTP, DHCP, or through software.

D

Subbase & Manual Valves

H Series Micro

Modulflex Series

H Series ISO

Network Connectivity

DX ISOMAX Series

Valvair II Series



For inventory, lead times, and kit lookup, visit www.pdnplu.com

BL67-GW-EN-DN

Modbus/TCP Communication Module with DeviceNet Subnet

BL67-GW-EN-IP-DN

EtherNet/IP™ Communication Module with DeviceNet Subnet



DeviceNet OUT

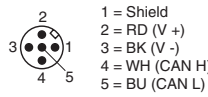

M12 D-code Ethernet in Wiring, view into female connector

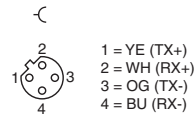

7/8 Mini Power in wiring, view into male connector

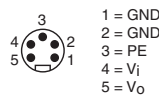

With BL Remote DeviceNet subnet functionality, each communication module has its own DeviceNet master which provides a connection for 63 DeviceNet nodes with additional inputs, outputs, and solenoid control. BL Remote DeviceNet subnet is independent of the main network, and is not visible to the master PLC.

BL67-PG-EN-DN

Modbus/TCP Programmable Communication Module with DeviceNet Subnet

BL67-PG-EN-IP-DN

EtherNet/IP™ Programmable Communication Module with DeviceNet Subnet



DeviceNet OUT

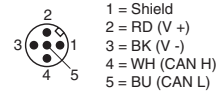

M12 D-code Ethernet in Wiring, view into female connector

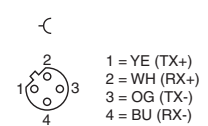

7/8 Mini Power in wiring, view into male connector

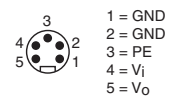

Communication modules are equipped with a built in standalone controller which is programmed according to IEC61131-3 with CoDeSys. Each module has 512KB Program memory with 32 bit RISC processor, and can run 1000 instructions in less than 1 ms. These network equipped modules are optimized to interface with PLC's with network capability or act as standalone controllers that need to interface with other network equipped devices.

With BL Remote DeviceNet subnet functionality, each communication module has its own DeviceNet master which provides a connection for 63 DeviceNet nodes with additional inputs, outputs, and solenoid control. BL Remote DeviceNet subnet is independent of the main network, and is not visible to the master PLC.

BL67-PG-DP

PROFIBUS Programmable Communication Module

BL67-PG-EN

Modbus/TCP Programmable Communication Module

BL67-PG-EN-IP

EtherNet/IP™ Programmable Communication Module



Profibus Wiring

M12 B-code bus out Wiring, view into female connector

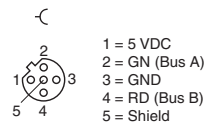

M12 B-code bus in Wiring, view into female connector

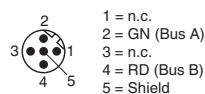

Ethernet Wiring

M12 D-code Ethernet in Wiring, view into female connector

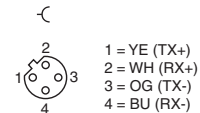

7/8 Mini Power in wiring, view into male connector Common to modules

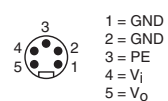

Communication modules are equipped with a built in standalone controller which is programmed according to IEC61131-3 with CoDeSys. Each module has 512KB Program memory with 32 bit RISC processor, and can run 1000 instructions in less than 1 ms. These network equipped modules are optimized to interface with PLC's with network capability or act as standalone controllers that need to interface with other network equipped devices.



For inventory, lead times, and kit lookup, visit www.pdnplu.com

D
 Subbase & Manual Valves
 H Series Micro
 Modulflex Series
 H Series ISO
 Network Connectivity
 DXISOMAX Series
 Valvair II Series

Base Modules													
	BL67-B-4M8	BL67-B-8M8	BL67-B-1M12	BL67-B-1M12-8	BL67-B-2M12	BL67-B-2M12-P	BL67-B-4M12	BL67-B-4M12-P	BL67-B-1M23	BL67-B-1M23-19	BL67-B-1RSM	BL67-B-1RSM-4	BL67-1RSM-VO
Power Extender Modules													
BL67-PF-24VDC											✓	✓	✓
Digital Input Modules													
BL67-4DI-P	✓				✓	✓	✓		✓				
BL67-8DI-P		✓					✓	✓	✓				
BL67-4DI-PD	✓				✓	✓	✓		✓				
BL67-8DI-PD		✓					✓	✓	✓				
BL67-4DI-N	✓				✓	✓	✓		✓				
BL67-8DI-N		✓					✓	✓	✓				
Digital Output Modules													
BL67-4DO-0.5A-P	✓				✓	✓	✓		✓				
BL67-4DO-2A-P	✓				✓	✓	✓		✓				
BL67-8DO-0.5A-P		✓					✓	✓	✓				
BL67-16DO-0.1A-P										✓			
BL67-4DO-2A-N	✓				✓	✓	✓		✓				
BL67-8DO-0.5A-N		✓					✓	✓	✓				
Relay Output Modules													
BL67-8DO-R-NO								✓					
Digital Input / Output Modules													
BL67-4DI4DO-PD		✓					✓	✓	✓				
Configurable Digital Input / Output Modules													
BL67-8XSG-PD		✓					✓	✓	✓				
Analog Input Modules													
BL67-2AI-I					✓								
BL67-2AI-V					✓								
BL67-4AI-V/I							✓						
BL67-2AI-PT					✓								
BL67-2AI-TC					✓								
Analog Output Modules													
BL67-2AO-I					✓								
BL67-2AO-V					✓								
Technology Modules													
BL67-1RS232			✓	✓					✓				
BL67-1RS485/422			✓	✓					✓				
BL67-1SSI				✓					✓				
BL67-1CNT/ENC				✓					✓				
BL67-1CVI			✓										
BL Ident® RFID Modules													
BL67-2RFID-A					✓								
BL67-2RFID-S					✓								



For inventory, lead times, and kit lookup, visit www.pdnplu.com

D214

Parker Hannifin Corporation
 Pneumatic Division
 Richland, Michigan
www.parker.com/pneumatics

System Supply via the Module Bus

The number of BL67 modules that can be powered by the communication module, depends on the nominal current draw of all the modules in the system. The total bus power current consumption of the installed BL67 modules may not exceed 1.5 A. The total field power current for inputs may not exceed 4 A, and the total field power for outputs may not exceed 8 A for DeviceNet and CANopen with power over the network, or 10A for all other communication modules.

When using the software PACTware, the menu item <Station - Verify> will automatically generate an error message if the system supply via the module bus is not reliably ensured.

Nominal Current Consumption

The following table shows the nominal current consumption of the various BL67 modules:

Modules	Bus power current (mA)	Field power for inputs ¹⁾ (mA)	Field power for outputs (mA)
PROFIBUS-DP communication module	0		150
DeviceNet communication module	0		150
CANopen communication module	0		150
Ethernet communication module	0		150
Valve driver with 16 outputs	30		< 109 mA (plus load current)
Valve driver with 32 outputs	60		< 218 mA (plus load current)
BL67-PF-24VDC	30		9
BL67-4DI-P	30	< 49 mA	
BL67-4DI-N	30	< 10 mA	
BL67-4DI-PD	30	< 109 mA	
BL67-8DI-P	30	< 49 mA	
BL67-8DI-N	30	< 10 mA	
BL67-8-DI-PD	30	< 109 mA	
BL67-4DO-0.5A-P	30		< 109 mA (plus load current)
BL67-4DO-2A-P	30		< 109 mA (plus load current)
BL67-4DO-2A-N	30		< 109 mA (plus load current)
BL67-8DO-0.5A-P	30		< 109 mA (plus load current)
BL67-8DO-0.5A-N	30		< 109 mA (plus load current)
BL67-16DO-0.1A-P	30		< 109 mA (plus load current)
BL67-4DI4DO-PD	30		< 109 mA (plus load current)
BL67-8XSG-PD	30		< 109 mA (plus load current)
BL67-8DO-R-NO	30		< 109 mA (plus load current)
BL67-2AI-V	35	< 22 mA	
BL67-2AI-I	35	< 22 mA	
BL67-4AI-I/V	35	< 22 mA	
BL67-2AI-TC	35	< 40 mA	
BL67-2AI-PT	45	< 58 mA	
BL67-2AO-I	40		< 62 mA
BL67-2AO-V	60		< 67 mA
BL67-1RS232	140	< 90 mA	
BL67-1RS485/422	60	< 42 mA	
BL67-1SSI	50	< 39 mA	
BL67-1CNT/ENC	30	< 109 mA	
BL67-1CVI	30	< 109 mA	

1) Is limited to 4A by means of the integrated short-circuit protection.



For inventory, lead times, and kit lookup, visit www.pdnplu.com

Part Numbers

Digital Input Modules

I/O modules	Voltage	Part number
8 PNP input module	7 to 30 VDC	BL67-8DI-P
8 PNP input module, with diagnostics	7 to 30 VDC	BL67-8DI-PD
8 NPN input module	24 VDC	BL67-8DI-N



Base module	Part number
8 x M8, 3 pole, female	BL67-B-8M8
4 x M12, 5 pole, female, A-code	BL67-B-4M12
4 x M12, 5 pole, female, A-code	BL67-B-4M12-P
1 x M23, 12 pole, female	BL67-B-1M23



H Series ISO & Network Connectivity Turck Network Portal

I/O modules	Voltage	Part number
4 PNP input module	7 to 30 VDC	BL67-4DI-P
4 PNP input module, with diagnostics	7 to 30 VDC	BL67-4DI-PD
4 NPN input module	24 VDC	BL67-4DI-N

Base module	Part number
4 x M8, 3 pole, female	BL67-B-4M8
2 x M12, 5 pole, female, A-code	BL67-B-2M12
2 x M12, 5 pole, female, A-code	BL67-B-2M12-P
4 x M12, 5 pole, female, A-code	BL67-B-4M12
1 x M23, 12 pole, female	BL67-B-1M23



D

Digital Output Modules

I/O modules	Output current	Part number
8 PNP output module	0.5 amps per channel	BL67-8DO-0.5A-P
8 NPN output module	0.5 amps per channel	BL67-8DO-0.5A-N



Base module	Part number
8 x M8, 3 pole, female	BL67-B-8M8
4 x M12, 5 pole, female, A-code	BL67-B-4M12
4 x M12, 5 pole, female, A-code	BL67-B-4M12-P
1 x M23, 12 pole, female	BL67-B-1M23



I/O modules	Output Current	Part number
4 PNP output module	0.5 amps per channel	BL67-4DO-0.5A-P
4 PNP output module	2 amps per channel	BL67-4DO-2A-P
4 PNP output module	4 amps per channel	BL67-4DO-4A-P
4 NPN output module	2 amps per channel	BL67-4DO-2A-N

Base module	Part number
4 x M8, 3 pole, female	BL67-B-4M8
2 x M12, 5 pole, female, A-code	BL67-B-2M12
2 x M12, 5 pole, female, A-code	BL67-B-2M12-P
4 x M12, 5 pole, female, A-code	BL67-B-4M12
1 x M23, 12 pole, female	BL67-B-1M23



Subbase & Manual
Valves

H Series
Micro

Modulflex
Series

H Series
ISO

Network
Connectivity

DX ISOMAX
Series

Valvair II
Series

Most popular.



For inventory, lead times, and kit lookup, visit www.pdnplu.com

Part Numbers

Digital Output Modules

I/O modules	Output current	Part number
16 PNP output module	0.14 amps per channel	BL67-16DO-0.1A-P

Base module	Part number
 1 x M23, 19 pole, female	BL67-B-1M23-19

Relay Output Modules

I/O modules	Output current	Part number
8 normally open relays	0.14 amps per channel	BL67-8DO-R-NO

Base module	Part number
 4 x M12, 5 pole, female, A-code	BL67-B-4M12-P

Analog Input Modules

I/O modules	Input type	Part number
4 configurable current or voltage analog input module	4 to 20 mA or 0 to 20 mA -10 to +10 VDC or 0 to +10 VDC	BL67-4AI-V/I

Base module	Part number
 4 x M12, 5 pole, female, A-code	BL67-B-4M12

I/O modules	Input type	Part number
2 current analog input module	4 to 20 mA or 0 to 20 mA	BL67-2AI-I
2 voltage analog input module	-10 to +10 VDC or 0 to +10 VDC	BL67-2AI-V
2 temperature analog input module	PT100, PT200, PT500, PT1000, Ni100, Ni1000	BL67-2AI-PT
2 temperature analog input module	Type B, E, J, K, N, R, S, T	BL67-2AI-TC

Base module	Part number
 2 x M12, 5 pole, female, A-code	BL67-B-2M12

 Most popular.

H Series ISO & Network Connectivity Turck Network Portal

Combination Input / Output Modules

I/O modules	Input voltage & output current	Part number
4 PNP output 4 PNP input module, with diagnostics	7 to 30 VDC 0.5 Amps	BL67-4DI4DO-PD
8 PNP configurable input or output module, with diagnostics	7 to 30 VDC 0.5 Amps	BL67-8XSG-PD

Base module	Part number
 8 x M8, 3 pole, female	BL67-B-8M8

Base module	Part number
 4 x M12, 5 pole, female, A-code	BL67-B-4M12

Base module	Part number
 4 x M12, 5 pole, female, A-code	BL67-B-4M12-P

Analog Output Modules

I/O modules	Input type	Part number
4 voltage analog output module	-10 to +10 VDC or 0 to +10 VDC	BL67-4AO-V

Base module	Part number
 4 x M12, 5 pole, female, A-code	BL67-B-4M12

I/O modules	Input type	Part number
2 current analog output module	4 to 20 mA or 0 to 20 mA	BL67-2AO-I
2 voltage analog output module	-10 to +10 VDC or 0 to +10 VDC	BL67-2AO-V

Base module	Part number
 2 x M12, 5 pole, female, A-code	BL67-B-2M12



For inventory, lead times, and kit lookup, visit www.pdnplu.com

D217

Parker Hannifin Corporation
Pneumatic Division
Richland, Michigan
www.parker.com/pneumatics

D

Subbase & Manual Valves

H Series Micro

Modulflex Series

H Series ISO

Network Connectivity



DX ISOMAX Series

Valvair II Series

Part Numbers

Combination Analog Input / Output Modules

I/O modules	Output current	Part number
4 configurable input and 4 configurable output current or voltage analog module	4 to 20 mA or 0 to 20 mA -10 to +10 VDC or 0 to +10 VDC	BL67-4AI4AO-V/I

Base module	Part number
 8 x M8, 3 pole, female	BL67-B-8M8
 4 x M12, 5 pole, female, A-code	BL67-B-4M12

CANopen Subnet Module

Extender module	Capacity	Part number
1 CANopen connection	64 bits of inputs or outputs	BL67-1CVI

Base module	Part number
 1 x M12, 5 pole, female, A-code	BL67-B-1M12



IO-Link Class A Master

Extender module	Part number
4 master channels	BL67-4IOL

Base module	Part number
 4 x M12, 5 pole, female, A-code	BL67-B-4M12

Power Extender Module

Extender module	Current capacity	Part number
24 VDC field power module	10 amps input	BL67-PF-24VDC

Base module	Part number
 5 pole mini connector to supply bus power and field power	BL67-B-1RSM
 5 pole mini connector to field power only	BL67-B-1RSM-VO
 4 pole mini connector to supply bus power and field power	BL67-B-1RSM-4

 Most popular.



H Series ISO & Network Connectivity Turck Network Portal

I/O modules	Output current	Part number
2 configurable input and 2 configurable output current or voltage analog module	4 to 20 mA or 0 to 20 mA -10 to +10 VDC or 0 to +10 VDC	BL67-2AI2AO-V/I

Base module	Part number
 8 x M8, 3 pole, female	BL67-B-8M8



Serial Interface Module

Extender module	Capacity	Part number
1 RS232 serial interface	300 to 115200 bps	BL67-1RS232
1 RS485 or 422 serial interface	300 to 115200 bps	BL67-1RS485/422

Base module	Part number
 1 x M12, 5 pole, female, A-code	BL67-B-1M12
 1 x M12, 8 pole, female, A-code	BL67-B-1M12-8
 1 x M23, 12 pole, female	BL67-B-1M23

SSI and Counting Modules

Extender module	Capacity	Part number
1 SSI sensor interface	65 kbps up to 1 Mbps	BL67-1SSI
1 counter interface	Up to 250 kHz	BL67-1CNT/ENC

Base module	Part number
 1 x M12, 8 pole, female, A-code	BL67-B-1M12-8
 1 x M23, 12 pole, female	BL67-B-1M23

D

Subbase & Manual
Valves

H Series
Micro

Modulflex
Series

H Series
ISO

Network
Connectivity

DXISOMAX
Series

Valvair II
Series



For inventory, lead times, and kit lookup, visit www.pdnplu.com

Digital PNP Input Modules

DC Input Module	BL67-4DI-P	BL67-8DI-P	BL67-4DI-PD	BL67-8DI-PD
Number of inputs	4	8	4	8
Sensor requirement	PNP Sourcing		PNP Sourcing	
Voltage, on-state input, nom.	24 VDC		24 VDC	
Field power for inputs current consumption	49 mA		109 mA	
Bus power current consumption	30 mA		30 mA	
Low level signal voltage	<4.5 V		<4.5 V	
High level signal voltage	7...30V		7...30V	
Low level signal current	<1.5 mA		<1.5 mA	
High level signal current	2.1...3.7 mA		2.1...3.7 mA	
Type of diagnostics	Group Diagnostics		Channel Diagnostics	
Short circuit protection	Group Protection		Channel Protection	
Input delay	0.25 ms		0.25; 2.5 ms	

PNP (Sourcing)

PNP input modules provide sourcing capabilities. When the input field device is passing, current flows from the input device into the Turck input module.

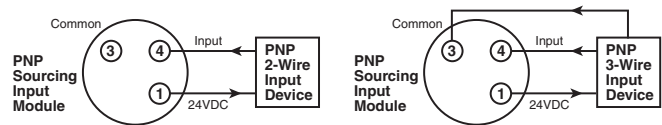

Digital NPN Input Modules

Digital DC Input Module	BL67-4DI-N	BL67-8DI-N
Number of inputs	4	8
Sensor requirement	NPN Sinking	NPN Sinking
Voltage, on-state input, nom.	24 VDC	24 VDC
Field power for inputs current consumption	10 mA	10 mA
Bus power current consumption	30 mA	30 mA
Low level signal voltage	>7 V	>7 V
High level signal voltage	<5 V	<5 V
Low level signal current	<2.5 mA	<1.2 mA
High level signal current	>3 mA	>1.5 mA
Type of diagnostics	Group Diagnostics	Group Diagnostics
Short circuit protection	Group Protection	Group Protection
Input delay	0.25 ms	0.25 ms

NPN (Sinking)

NPN input modules provide sinking capabilities. When the input field device is passing, current out of the Turck input module into the field input device.

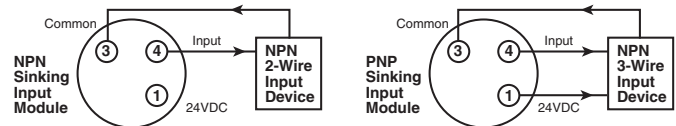

For inventory, lead times, and kit lookup, visit www.pdnplu.com

D219

Parker Hannifin Corporation
 Pneumatic Division
 Richland, Michigan
www.parker.com/pneumatics

D

Subbase & Manual Valves

H Series Micro

Modulflex Series

H Series ISO

Network Connectivity

DX ISOMAX Series

Valvair II Series

Digital PNP Output Modules

Digital DC Output Module	BL67-4DO-0.5A-P	BL67-8DO-0.5A-P	BL67-4DO-2A-P	BL67-16DO-0.1A-P
Number of outputs	4	8	4	16
Sensor requirement	PNP Sourcing	PNP Sourcing	PNP Sourcing	PNP Sourcing
Output voltage	24 VDC	24 VDC	24 VDC	24 VDC
Field power for outputs current consumption	109 mA (Plus load current)	109 mA (Plus load current)	109 mA (Plus load current)	109 mA (Plus load current)
Bus power current consumption	30 mA	30 mA	30 mA	30 mA
Output current per channel	0.5 A	0.5 A	2.0A	0.1 A
Output delay	3 ms	3 ms	3 ms	3 ms
Load type	Resistive, Inductive, Lamp Load	Resistive, Inductive, Lamp Load	Resistive, Inductive, Lamp Load	Resistive, Inductive
Load resistance, resistive	>48 Ohm	>48 Ohm	>12 Ohm	>250 Ohm
Load resistance, inductive	<1.2 H	<1.2 H	<1.2 H	<1.2 H
Lamp load	< 3W	< 3W	< 10W	< 10W
Switching frequency, resistive	<200 Hz	<200 Hz	<200 Hz	<200 Hz
Switching frequency, inductive	< 2 Hz	< 2 Hz	< 2 Hz	< 2 Hz
Switching frequency, lamp load	< 20 Hz	< 20 Hz	< 20 Hz	< 20 Hz
Short-circuit protection	Group Protection	Group Protection	Group Protection	Group Protection
Diagnostic bits	4	8	4	16

PNP (Sourcing)

PNP input modules provide sourcing capabilities. When the input field device is passing, current flows from the input device into the Turck input module.

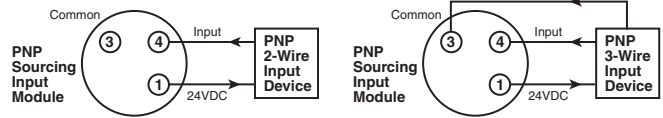

Digital NPN Output Modules

Digital DC Output Module	BL67-8DO-0.5A-N	BL67-4DO-2A-N
Number of outputs	8	4
Sensor requirement	NPN Sinking	NPN Sinking
Output voltage	24 VDC	24 VDC
Field power for outputs current consumption	109 mA (Plus load current)	109 mA (Plus load current)
Bus power current consumption	30 mA	30 mA
Output current per channel	0.5 A	2.0 A
Output delay	3 ms	3 ms
Load type	Resistive, Inductive, Lamp Load	Resistive, Inductive, Lamp Load
Load resistance, resistive	>48 Ohm	>48 Ohm
Load resistance, inductive	<1.2 H	<1.2 H
Lamp load	< 3W	< 3W
Switching frequency, resistive	<200 Hz	<200 Hz
Switching frequency, inductive	< 2 Hz	< 2 Hz
Switching frequency, lamp load	< 20 Hz	< 20 Hz
Short-circuit protection	Group Protection	Group Protection
Diagnostic bits	4	8

NPN (Sinking)

NPN input modules provide sinking capabilities. When the input field device is passing, current out of the Turck input module into the field input device.

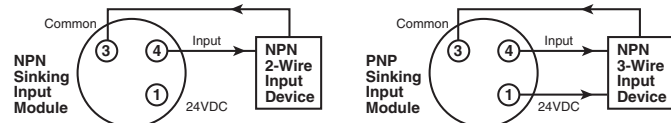

D
 Subbase & Manual Valves
 H Series Micro
 Modutex Series
 H Series ISO
 Network Connectivity
 DX ISOMAX Series
 Valvair II Series



For inventory, lead times, and kit lookup, visit www.pdnplu.com

Relay Output Modules

Relay Output Module	BL67-8DO-R-NO
Number of outputs	8
Output type	Relay
Output voltage	24 VDC
Field power for outputs current consumption	109 mA (Plus load current)
Bus power current consumption	30 mA
Output current per channel	100 mA
Output delay	3 ms
Load type	Resistive, TTL logic
Switching resistor	<31 Ohm
Switching frequency, resistive	<200 Hz
Short-circuit protection	None

Combination Digital Modules

Combination Input and Output Modules	BL67-4DI4DO-PD	BL-67-8XSG-PD
Number of outputs	4	Configurable 0 to 8
Number of inputs	4	Configurable 0 to 8
Total channels	8	8
Sensor requirement	PNP Sourcing	PNP Sourcing
Voltage, on-state input, nom.	24 VDC	24 VDC
Output voltage	24 VDC	24 VDC
Field power for outputs current consumption	109 mA	109 mA
Bus power current consumption	30 mA	30 mA
Input low level signal voltage	<4.5 V	<4.5 V
Input high level signal voltage	7...30V	7...30V
Input low level signal current	<1.5 mA	<1.5 mA
Input high level signal current	2.1...3.7 mA	2.1...3.7 mA
Input delay	0.25; 2.5 ms	0.25; 2.5 ms
Output current per channel	0.5 A	0.5 A
Output delay	3 ms	3 ms
Load type	Resistive, Inductive, Lamp Load	Resistive, Inductive, Lamp Load
Load resistance, resistive	>48 Ohm	>48 Ohm
Load resistance, inductive	<1.2 H	<1.2 H
Lamp load	< 3W	< 3W
Switching frequency, resistive	<200 Hz	<200 Hz
Switching frequency, inductive	< 2 Hz	< 2 Hz
Switching frequency, lamp load	< 20 Hz	< 20 Hz
Short-circuit protection	Channel Protection	Channel Protection
Diagnostic bits	8	12

D

Subbase & Manual Valves

H Series Micro

Moduflex Series

H Series ISO

Network Connectivity

DX ISOMAX Series

Valvair II Series



For inventory, lead times, and kit lookup, visit www.pdnplu.com

D221

Parker Hannifin Corporation
Pneumatic Division
Richland, Michigan
www.parker.com/pneumatics

Analog Input Modules

Analog Input Module	BL67-2AI-I	BL67-2AI-V	BL67-4AI-V/I
Number of inputs	2	2	4
Nominal voltage	24 VDC	24 VDC	24 VDC
Field power for inputs current consumption	22 mA	22 mA	22 mA
Bus power current consumption	35 mA	35 mA	35 mA
Analog input type	0/4...20mA	-10/0...+10 VDC	0/4...20mA or -10/0...+10 VDC
Input resistance	<0.125 kOhm	<98.5 kOhm	<0.125 kOhm or <98.5 kOhm
Maximum limiting frequency	50 Hz		20 Hz
Fault limit @ 23 degree C	<0.2%		<0.3%
Repeatability	0.05%	0.05%	0.05%
Temperature coefficient (ppm/degree C of full scale)	<300	<150	<300
Resolution	16 Bit	16 Bit	16 Bit
Measuring principle	Sigma Delta	Sigma Delta	Sigma Delta
Measured value display	16 bit signed integer, 12 bit full range left justified	16 bit signed integer, 12 bit full range left justified	16 Bit signed integer, 12 bit full range left justified
Diagnostic bits	16		32

Temperature Inputs

Analog Input Module	BL67-2AI-PT	BL67-2AI-TC
Number of inputs	2	2
Nominal voltage	24 VDC	24 VDC
Field power for inputs current consumption	58 mA	40 mA
Bus power current consumption	45 mA	35 mA
Temperature input type	PT100, PT200, PT500, PT1000, Ni100, Ni1000	B, E, J, K, N, R, S, T
Voltage resolution	n/a	+/- 50mV; <2uV
Fault limit @ 23 degree C	<0.2%	<0.2%
Repeatability	0.05%	0.05%
Temperature coefficient (ppm/degree c of full scale)	<300	<300
Resolution	16 Bit	16 Bit
Measured value display	16 bit signed integer, 12 bit full range left justified	16 bit signed integer, 12 bit full range left justified
Diagnostic bits	16	16

D
 Subbase & Manual Valves
 H Series Micro
 Modulflex Series
 H Series ISO
 Network Connectivity
 DXISOMAX Series
 Valvair-II Series



For inventory, lead times, and kit lookup, visit www.pdnplu.com

D222

Parker Hannifin Corporation
 Pneumatic Division
 Richland, Michigan
www.parker.com/pneumatics

Analog Input Modules

Analog Input Module	BL67-2AO-I	BL67-2AO-V
Number of inputs	2	2
Nominal voltage	24 VDC	24 VDC
Field power for outputs current consumption	62 mA	67 mA
Bus power current consumption	40 mA	60 mA
Analog output type	0/4...20mA	-10/0...+10 VDC
Output current per channel	n/a	250 mA
Load resistance, resistive	<0.45 kOhm	> 1kOhm
Load resistance, inductive	<1 mH	n/a
Load resistance, capacitive	n/a	> 1 uF
Transmission frequency	<200 Hz	<100 Hz
Fault limit @ 23 degree C	<0.2%	<0.2%
Repeatability	0.05%	0.05%
Temperature coefficient (ppm/degree c of full scale)	<150	<300
Resolution	16 bit	16 bit
Measured value display	16 bit signed integer, 12 bit full range left justified	16 bit signed integer, 12 bit full range left justified

Combination Analog Modules

Analog Combination Module	BL67-4AI4AO-V/I	BL67-2AI2AO-V/I
Number of analog inputs	4	2
Number of analog outputs	4	2
Nominal voltage	24 VDC	24 VDC
Field power for outputs current consumption	67 mA	67 mA
Bus power current consumption	60 mA	60 mA
Analog input type	0/4...20mA or -10/0...+10 VDC	0/4...20mA or -10/0...+10 VDC
Input resistance	0.065 or 225 kOhm	0.065 or 225 kOhm
Maximum limiting frequency	20 Hz	20 Hz
Fault limit @ 23 degree c	<0.3%	<0.3%
Repeatability	0.05%	0.05%
Temperature coefficient (ppm/degree c of full scale)	<300	<300
Resolution	16 bit	16 bit
Measuring principle	Sigma Delta	Sigma Delta
Measured value display	16 bit signed integer, 12 bit full range left justified	16 bit signed integer, 12 bit full range left justified
Analog output type	-10/0...+10 VDC	-10/0...+10 VDC
Output current per channel	250 mA	250 mA
Load resistance, resistive	>1 kOhm	>1 kOhm
Load resistance, capacitive	<1 uF	<1 uF
Transmission frequency	<100 Hz	<100 Hz
Fault limit @ 23 degree C	<0.3%	<0.3%
Repeatability	0.05%	0.05%
Temperature coefficient (ppm/degree c of full scale)	<300	<300
Resolution	16 bit	16 bit
Measured value display	16 bit signed integer, 12 bit full range left justified	16 bit signed integer, 12 bit full range left justified
Diagnostic bits	8	4

D

Subbase & Manual Valves

H Series Micro

Moduflex Series

H Series ISO

Network Connectivity

DX ISOMAX Series

Valvair II Series



For inventory, lead times, and kit lookup, visit www.pdnplu.com

D223

Parker Hannifin Corporation
 Pneumatic Division
 Richland, Michigan
www.parker.com/pneumatics

Power Extender Module

Power Extender Module	BL67-PF-24VDC
Nominal voltage	24 VDC
Field power for outputs current consumption	9 mA
Bus power current consumption	30 mA
Supply for field power for inputs current	4.0 A
Supply for field power for outputs current	10 A
Diagnostic bits	3

RS232 Interface

RS232 Interface	BL67-1RS232
Number of channels	1
Field power for inputs current consumption	90 mA
Bus power current consumption	140 mA
Transmission level active (u rs1)	-15 to -3 VDC
Transmission level inactive (urso)	3 to 15 VDC
Common-mode range (ugl)	-7 to 12 VDC
Transmission signals	RxD, TxD, RTS, CTS
Data buffer received	128 Byte
Send data buffer	64 Byte
Connection type	Full Duplex
Transmission rate	300 to 115200 bps
Parameter	Transmission Rate, Diagnostics, Data Bits, Stop Bits, XON - Character, XOFF - Character, Parity, Flow Control
Cable length	15 m
Diagnostic bits	8

RS485 / 422 Interface

RS485/422 Interface	BL67-1RS485/422
Number of channels	1
Field power for inputs current consumption	42 mA
Bus power current consumption	60 mA
Transmission signals	RxD, TxD
Connection type	2 Wire Half Duplex or 4 Wire Full Duplex
Transmission rate	300 to 115200 bps
Parameter	RS485/422, Transmission Rate, Diagnostics, Data Bits, Stop Bits, XON - Character, XOFF - Character, Parity, Flow Control
Cable length	1000 m
Line impedence	120 Ohm
Bus termination	External
Diagnostic bits	8

D
Subbase & Manual
Valves
H Series
Micro
Modulflex
Series
H Series
ISO
Network
Connectivity
DXISOMAX
Series
Valvair II
Series



For inventory, lead times, and kit lookup, visit www.pdnplu.com

D224

Parker Hannifin Corporation
Pneumatic Division
Richland, Michigan
www.parker.com/pneumatics

SSI Sensor Interface

SSI Sensor Interface	BL67-1SSI
Number of channels	1
Field power for inputs current consumption	39 mA
Bus power current consumption	50 mA
Transmission signals	CL, D
Connection type	4 Wire Full Duplex (Clock Output/Signal Input)
Transmission rate	62.5 kbps up to 1 Mbps
Parameter	Transmission Rate, Diagnostics, Data Format (Binary / GRAY coded), Data Fram Bits (1-32), Number of Invalid Bits (LSB: 0-15, MSB 0-7)
Cable length	30 m
Diagnostic bits	8

Counting Module

Counting Module	BL67-1CNT/ENC
Number of channels	1
Field power for inputs current consumption	109 mA
Bus power current consumption	30 mA
Input type	PNP
Output type	PNP
Output current per channel	0.5 A
Output delay	2 ms
Load type	Resistive
Frequency measurement	Up to 250 kHz
Speed measurement	Factor Configurable
Period duration measurement	2 usec
Upper count limit	0x80000000 up to 0xFFFFFFFF
Lower count limit	0x80000000 up to 0xFFFFFFFF
Short circuit protection	Channel Protection

CANopen Expansion Module

CANopen Expansion Module	BL67-1CVI
Number of channels	1
Field power for inputs current consumption	109 mA
Bus power current consumption	30 mA
Transmission signals	CAN High, CAN Low
Connection type	CANopen
Transmission speed	10 kbps up to 1 Mbps
Parameter	Transmission Rate, Diagnostics, Bus Termination, Range of I/O Data
Bus termination	Internal
Diagnostic bits	48
Max number of CANopen nodes	8
Max processing data per module	8 Byte
Max data per node	4 Byte



For inventory, lead times, and kit lookup, visit www.pdnplu.com

D225

Parker Hannifin Corporation
Pneumatic Division
Richland, Michigan
www.parker.com/pneumatics

D

Subbase & Manual Valves

H Series Micro

Moduflex Series

H Series ISO

Network Connectivity

DX ISOMAX Series

Valvair II Series

Power Distribution Options for Turck Network Portal

Turck Communication and I/O Modules - DeviceNet and CANopen, Power Over Network

The 24VDC power supply pins from the DeviceNet or CANopen network connection on the communication module provides a single power circuit. This circuit provides 1.5A bus power, 4A field power for inputs and 8A field power for outputs.

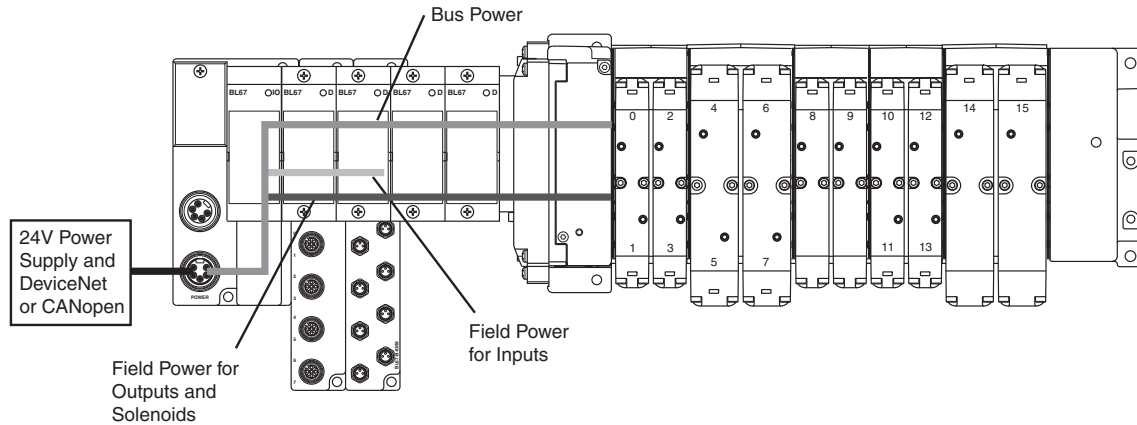

Turck Communication and I/O Modules - EtherNet/IP™, Modbus/TCP, PROFINET, PROFIBUS, and CANopen

An auxiliary 24VDC power supply from the communication module provides power across two separate circuits. The first circuit provides 1.5A bus power and 4A field power for inputs. The second circuit provides 10A field power for outputs which can be wired to an e-stop circuit to kill all outputs.

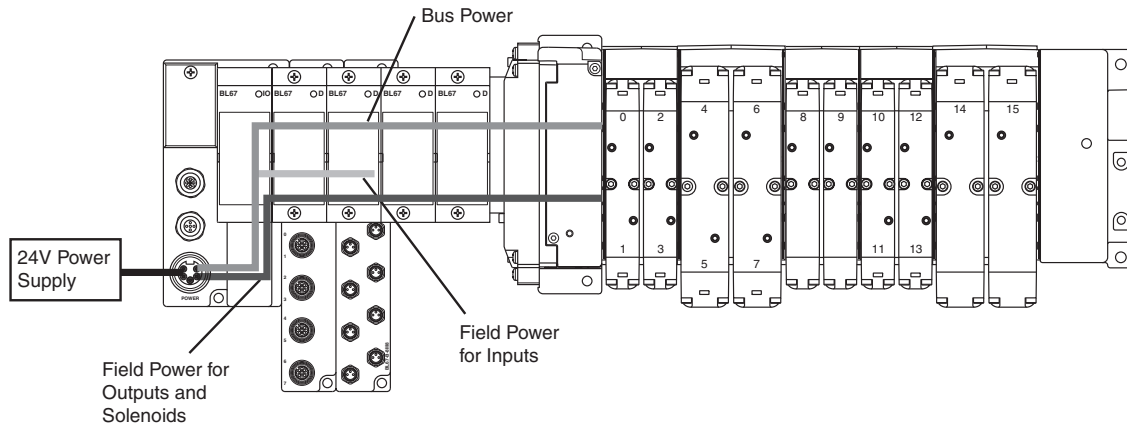

D
Subbase & Manual Valves
H Series Micro
Modulflex Series
H Series ISO
Network Connectivity
DX ISOMAX Series
Valvair II Series



For inventory, lead times, and kit lookup, visit www.pdnplu.com

D226

Parker Hannifin Corporation
 Pneumatic Division
 Richland, Michigan
www.parker.com/pneumatics

Power Distribution Options for Turk Network Portal (continued)

24VDC Power Extender Module (BL67-PF-24VDC) with Base Module BL67-B-1RSM

This configuration creates an auxiliary 24VDC power supply and provides power across two separate circuits, regardless of the communication module used. The first circuit provides 4A field power for inputs. The second circuit provides 10A field power for outputs which can be wired to an e-stop circuit to kill all outputs and solenoids to the right of the module. The 1.5A bus power is uninterrupted, and is still supplied from the communication module.

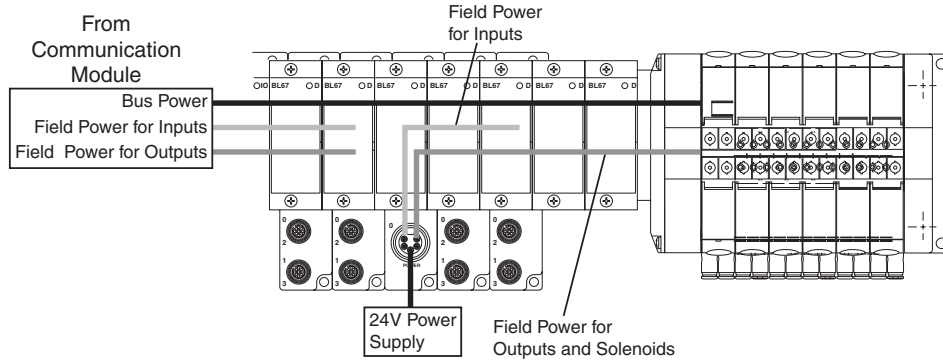

24VDC Power Extender Module (BL67-PF-24VDC) with Base Module BL67-B-1RSM-4

This configuration creates an auxiliary 24VDC power supply and provides power across one circuit, regardless of the communication module used. This circuit provides 4A field power for inputs and 10A field power for outputs. The 1.5A bus power is uninterrupted, and is still supplied from the communication module.

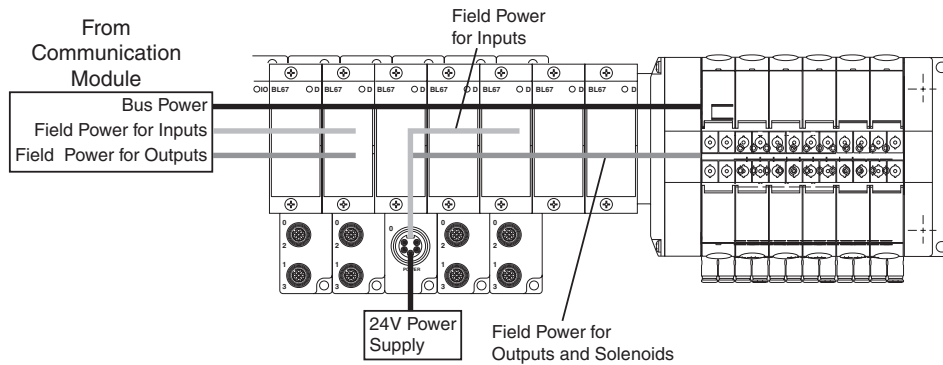

24VDC Power Extender Module (BL67-PF-24VDC) with Base Module BL67-B-1RSM-VO

This configuration creates an auxiliary 24VDC power supply and provides power across one circuit, regardless of the communication module used. This circuit provides 10A field power for outputs which can be wired to an e-stop circuit to kill all outputs and solenoids to the right of the module. The 1.5A bus power and 4A field power for inputs are uninterrupted, and are still supplied from the communication module.

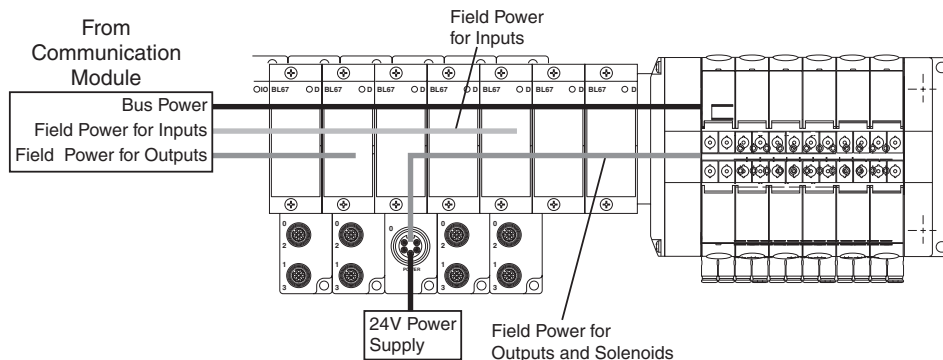

For inventory, lead times, and kit lookup, visit www.pdnplu.com

D227

Parker Hannifin Corporation
 Pneumatic Division
 Richland, Michigan
www.parker.com/pneumatics

D

Subbase & Manual Valves

H Series Micro

Moduflex Series

H Series ISO

Network Connectivity

DX ISOMAX Series

Valvair II Series

7/8" Mini Power Cables - P2H Network Node, H Series Network Portal, Turck Network Portal

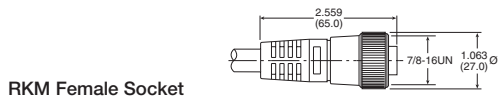

RKM Female Socket

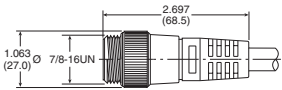

RSM Male Pins

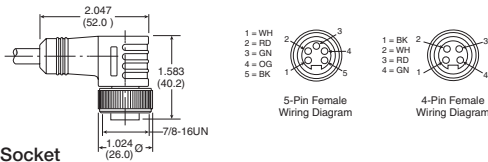

WKM Female Socket

Description	Part number
4-pin female to flying lead cable, 5 meters, TPE	RKM 46-5M/S1587
5-pin female to flying lead cable, 5 meters, TPE	RKM 56-5M/S1587
4-pin male to female cable, TPE	RSM RKM 46-x/S1587
5-pin male to female cable, TPE	RSM RKM 56-x/S1587
4-pin right angle female to flying lead cable, 5 meters, TPE	WKM 46-5M/S1587
5-pin right angle female to flying lead cable, 5 meters, TPE	WKM 56-5M/S1587

Where x = 2, 4, 5, 6, 8, 10 meter standard lengths

Power Tee - P2H Network Node, H Series Network Portal, Turck Network Portal

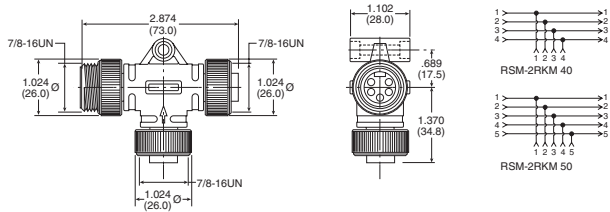

Description	Part number
4-pin Male to 2 female sockets	RSM-2RKM 40
5-pin Male to 2 female sockets	RSM-2RKM 50

D
 Subbase & Manual Valves
 H Series Micro
 Modulflex Series
 H Series ISO
 Network Connectivity
 DX ISOMAX Series
 Valvair II Series

M12 A-code Cables - P2M IO-Link, P2H IO-Link, H Series IO-Link Network Portal, Turck IO-Link Network Portal

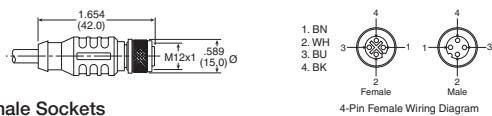

RKC Female Sockets

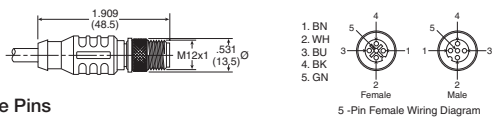

RSC Male Pins

Description	Part number
4-pin female to flying lead cable, PVC	RKC 4.4T-1
4-pin male to flying lead cable, PVC	RSC 4.4T-*
4-pin male to female cable, PVC	RKC 4.4T-*-RSC 4.4T
5-pin female to flying lead cable, TPE	RKC 4.5T-*/S1587
5-pin male to flying lead cable, TPE	RSC 4.5T-4/S1587
5-pin male to female cable, TPE	RKC 4.5T-*-RSC 4.5T/S1587

Where * = 1, 2, 3, 4 meter standard lengths

M8 Cables - H Series IO-Link Network Portal, Turck IO-Link Network Portal

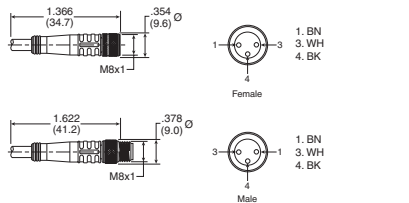

Description	Part number
3-pin female to flying lead cable, PUR	PKG 3M-4/S90
3-pin male to flying lead cable, PUR	PSG 3M-*/S90
3-pin male to female cable, PUR	PKG 3M-*-PSG 3M/S90

Where * = 1, 2, 3, 4 meter standard lengths

Most popular.



For inventory, lead times, and kit lookup, visit www.pdnplu.com

M23 Cables

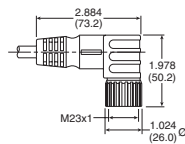
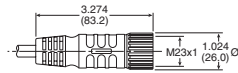

Description	Part number
12-pin, double ended female thread with male pins and female socket, PUR. Pinout optimized for H Series Network Portal.	CSCM CKCM 12-11-x/S90
19-pin, double ended female thread with male pins and female socket, PUR. Pinout optimized for H Series Network Portal.	CSM CKM 19-19-x/S90
19-pin, 90° double ended female thread with male pins and female socket, PUR. Pinout optimized for Turck Network Portal.	CSWM CKWM 19-19-x/CS12852

Where x = 1, 2, 3, 4 meter standard lengths

PROFIBUS Cables - P2M Network Node, Turck Network Portal

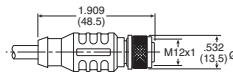
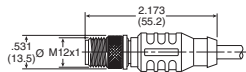

Description	Part number
M12 male to M12 female, PUR	RSSW RKSX 455-xM

Where x = 2, 4, 5, 6, 8, 10 meter standard lengths

RSSW Side, Male Pins

RKSX Side, Female Sockets

PROFIBUS Terminating Resistor - P2M Network Node, Turck Network Portal

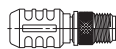

Male Pins

Description	Part number
M12 male pin terminating resistor	P8BPA00MB

Ethernet Cables - P2M Network Node, H Series Network Portal, Turck Network Portal

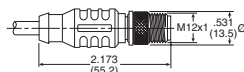
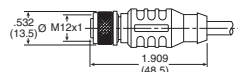

RKSD Side, Female Sockets

RSSD Side, Male Pins

Description	Part number
M12 female to M12 male, PUR	RSSD RKSD 443-xM
RJ45 to M12 male, PUR	RSSD RJ45S 443-2M

Where x = 2, 5, 10, 15, 20, 30 meter standard lengths

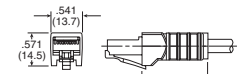

RJ45S Side

25-pin, D-Sub Cable (Female)

Description	Length	Part number
25-pin, D-sub cable, IP20, PUR	3 meters	P8LMH25M3A
25-pin, D-sub cable, IP20, PUR	9 meters	SCD259D
25-pin, D-sub cable, IP65, PUR	3 meters	SCD253W
25-pin, D-sub cable, IP65, PUR	9 meters	SCD259WE

Most popular.



For inventory, lead times, and kit lookup, visit www.pdnplu.com

D229

Parker Hannifin Corporation
Pneumatic Division
Richland, Michigan
www.parker.com/pneumatics

D

Subbase & Manual Valves

H Series Micro

Modulflex Series

H Series ISO

Network Connectivity

DX ISOMAX Series

Valvair II Series

Accessories, Cables & Cordsets

DeviceNet and CANopen Cables - P2M Network Node, H Series Network Portal, Turck Network Portal

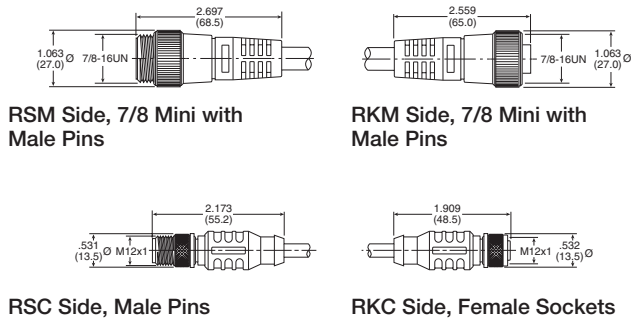

Description	Part Number
7/8" mini male to 7/8" mini female, PUR	RSM RKM 5711-xM
7/8" mini male to M12 female, PUR	RSM RKC 5711-xM
M12 male to M12 female, PUR	RSC RKC 5711-xM
M12 male to 7/8" mini female, PUR	RSC RKM 5711-xM

Where x = 2, 4, 5, 6, 8, 10 meter standard lengths

Bus Power Tee - P2M Network Node, H Series Network Portal, Turck Network Portal

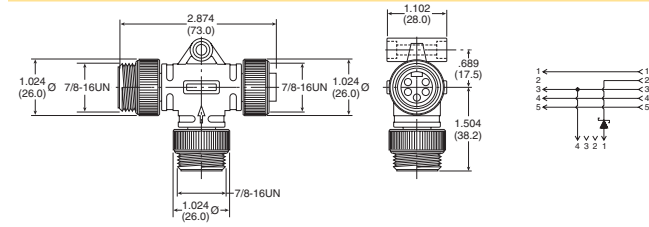

Description	Part Number
Bus power tee	RSM RKM 57 WSM 40 PST

For systems not equipped with Power over network, combines separate network and power feeds into the communication module. Includes reverse current protection

DeviceNet & CANopen Terminating Resistor - P2M Network Node, H Series Network Portal, Turck Network Portal

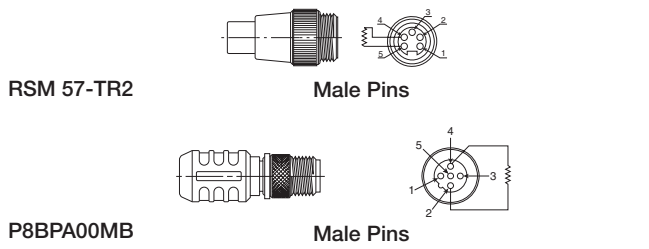

Description	Part Number
7/8" Mini Male Pin Terminating Resistor	RSM 57-TR2
M12 Male Pin Terminating Resistor	P8BPA00MA

M12 Power Splitter - PCH Network Portal, H Series Network Portal, Turck Network Portal, P2M IO-Link, P2H IO-Link

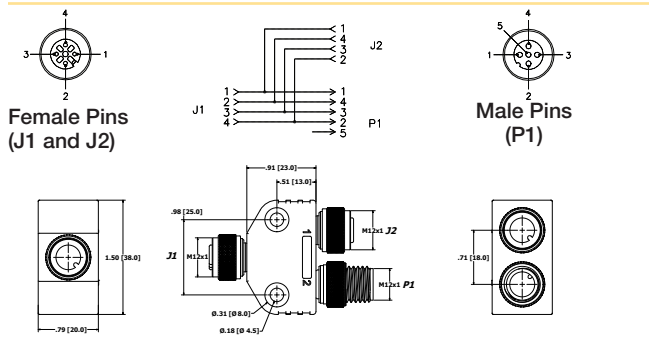

Description	Part Number
M12 Parallel Splitter	100010909

Most popular.



For inventory, lead times, and kit lookup, visit www.pdnplu.com

D230

Parker Hannifin Corporation
Pneumatic Division
Richland, Michigan
www.parker.com/pneumatics

D
 Subbase & Manual Valves
 H Series Micro
 Modutex Series
 H Series ISO
 Network Connectivity
 DX ISOMAX Series
 Valvair II Series

Turck with H Series ISO Valves

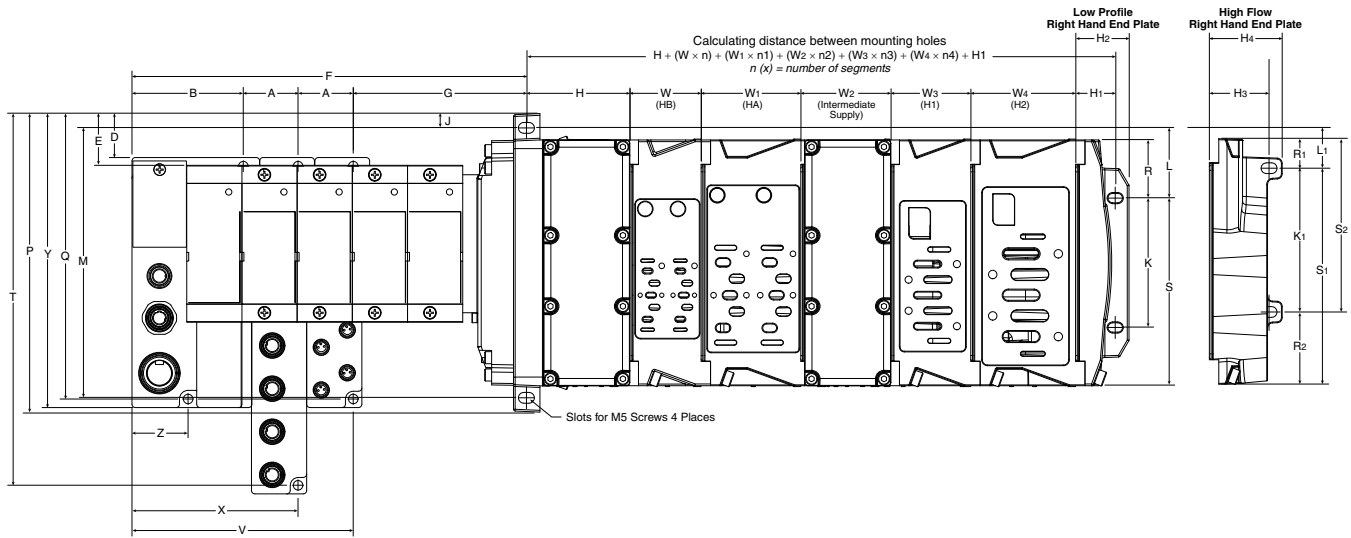

n (x) = number of segments

A	B	D	E	F	G	H	H1	H2	H3	H4	J
1.26 (32.0)	2.54 (64.5)	1.00 (25.4)	1.18 (29.9)	8.99 (228.4)	3.94 (100.1)	2.36 (60.0)	0.90 (23.0)	1.22 (31.0)	1.36 (34.6)	1.66 (42.3)	0.33 (8.3)
K	K1	L	L1	M	P	Q	R	R1	R2	S	S1
2.95 (75.0)	3.28 (83.4)	1.60 (40.7)	0.96 (24.3)	6.16 (156.5)	6.81 (173.1)	6.51 (165.4)	1.33 (33.7)	0.68 (17.3)	1.65 (41.8)	4.28 (108.8)	4.93 (125.2)
S2	T	V	W	W1	W2	W3	W4	X	Y	Z	
3.96 (100.7)	8.48 (215.4)	5.05 (128.3)	1.63 (41.3)	2.28 (57.8)	2.06 (52.3)	1.82 (46.3)	2.39 (60.8)	3.79 (96.3)	6.71 (170.4)	1.28 (32.5)	

Inches (mm)

H3 Manifold Assembly

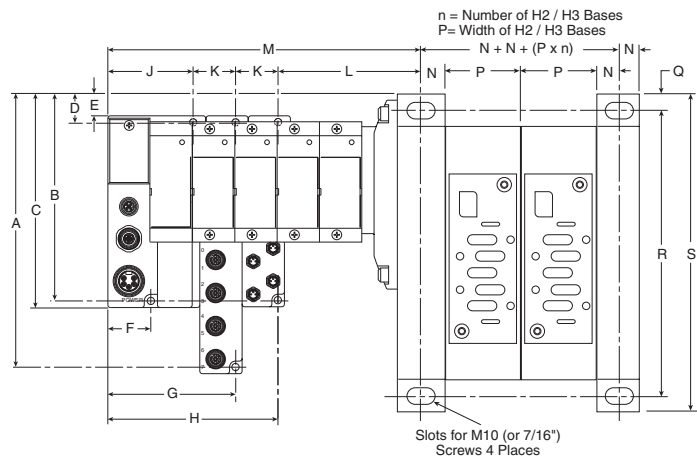

A	B	C	D	E	F	G	H	J	K	L	M	N	P	Q	R	S
8.62 (218.9)	6.65 (168.9)	6.85 (173.9)	1.33 (33.9)	1.14 (28.9)	1.28 (32.5)	3.79 (96.5)	5.06 (128.5)	2.53 (64.5)	1.26 (32)	4.34 (110)	See note 1	.65 (16.5)	2.80 (71)	.59 (15)	10.43 (265)	11.61 (295)

Note 1: M = J + L + n₂ x K, where n₂ = Number of Turck input / output modules
 Inches (mm)



For inventory, lead times, and kit lookup, visit www.pdnplu.com

D231

Parker Hannifin Corporation
 Pneumatic Division
 Richland, Michigan
www.parker.com/pneumatics

D

**Subbase & Manual
 Valves**

**H Series
 Micro**

**Moduflex
 Series**

**H Series
 ISO**

**Network
 Connectivity**

**DX ISOMAX
 Series**

**Valvair II
 Series**

DX ISOMAX Series

The ISOMAX range of directional control valves complies with ISO 15407-1 and VDMA 24563 for sizes 02 and 01 and ISO 5599-1 for sizes 1, 2 and 3. ISOMAX provides flows from 0.55 Cv to 4.15 Cv.

The ISOMAX range includes valves for pneumatic and electrical actuation with a wide choice of subbases and manifolds to suit different application needs.

All ISOMAX products use high-tech ceramic switching technology providing:

Excellent reliability

- Long life in excess of 100 million operations*
- Operates with lubricated or non-lubricated air
- Low sensitivity to air quality changes

High performance

- Slide valve concept allows high flow / size ratio and short response time due to short slide stroke and low friction

Stable long lasting performances

- Low friction switching: minimum wear of the valve member / seal assembly

Valves fitted with switchable selector to give internal or external pilot supply

Corrosion free and modern design

Vacuum operation

Dual pressure

* Refer to our warranty conditions.

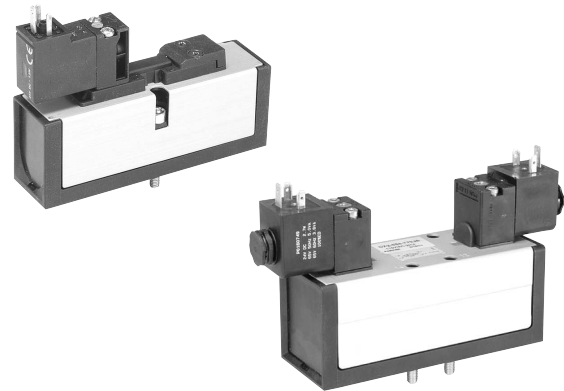

Operating information

Operating Pressure: Vacuum to 145 PSIG (10 bar)

Function		M.O.P (PSIG)
20, 21, 22, 23	2-position, spring return	36
50, 51, 53, 54	2-position, air return	30
04, 05, 06, 08	2-position	15
09, 11, 12, 27	3-position, CE	45
16, 18, 19, 25	3-position, APB	45

Working temperatures:

-10°C to 60°C (14°F to 140°F)

Storage temperatures:

-20°C to 70°C (-4°F to 158°F)

Material specifications

Body	Polyamide reinforced fiberglass
Casing	Anodized aluminum
End plates	Painted zinc plated steel
Function selector	Polyamide reinforced fiberglass
Screws	Zinc plated steel
Seals	Nitrile
Seat	Ceramic
Springs	Stainless steel
Top cover seals	Polyester
Valve members	Self lubricating acetal
Valve plate	Zinc

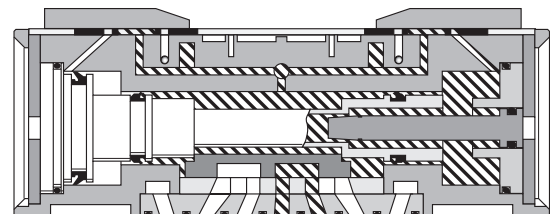
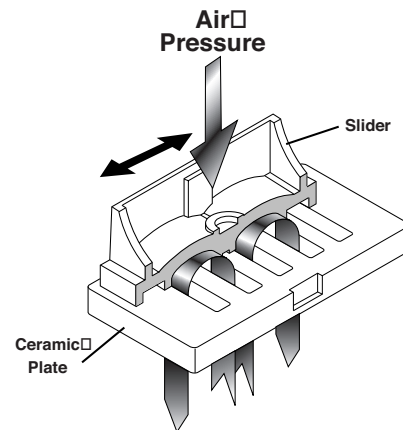
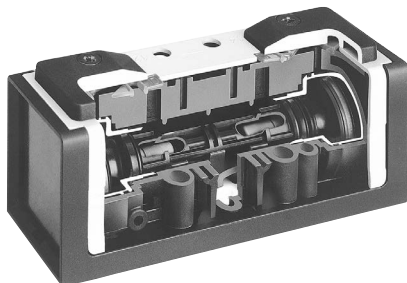

Remote Pilot

D

Subbase & Manifold Valves

H Series Micro

Modulflex Series

H Series ISO

Network Connectivity

DX ISOMAX Series

Valvair II Series





For inventory, lead times, and kit lookup, visit www.pdnplu.com

D232

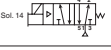
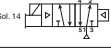
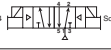

Parker Hannifin Corporation
Pneumatic Division
Richland, Michigan
www.parker.com/pneumatics

Common Part Numbers

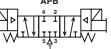
DX02 ISO Solenoid Valves

Symbol	Type	Cv	Operator	Pilot	Override	24 VDC	120 VAC
	4-way, 2-position, spring return	0.55	Single solenoid	Internal	Non-locking	DX02-621-951M	DX02-621-951J
	4-way, 2-position, air return	0.55	Single solenoid	Internal	Non-locking	DX02-651-951M	DX02-651-951J
	4-way, 2-position	0.55	Double solenoid	Internal	Non-locking	DX02-606-951M	DX02-606-951J
	4-way, 3-position, center exhaust	0.4	Double solenoid	Internal	Non-locking	DX02-611-951M	DX02-611-951J
	4-way, 3-position, all ports blocked	0.4	Double solenoid	Internal	Non-locking	DX02-616-951M	DX02-616-951J

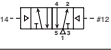
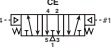
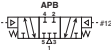

DX02 ISO Remote Pilot Valves

Symbol	Type	Cv	Operator	Pilot	Part Number
	4-way, 2-position, spring return	0.55	Single remote pilot	Remote	DX02-421-60
	4-way, 2-position, air return	0.55	Single remote pilot	Remote	DX02-451-60
	4-way, 2-position	0.55	Double remote pilot	Remote	DX02-406-60
	4-way, 3-position, center exhaust	0.4	Double remote pilot	Remote	DX02-411-60
	4-way, 3-position, all ports blocked	0.4	Double remote pilot	Remote	DX02-416-60





Torque Specifications

DX02: 15 to 25 in-lbs (1.69 to 2.82 Nm) DX01: 20 to 30 in-lbs (2.26 to 3.39 Nm)

Base / End Plate - 15407-1, Non Plug-in, Size DX02

	Description	NPT	BSPP
	Universal manifold base 2 station, end ported	PSHU115101P	PSHU115201P
	Universal end plate Non-collective wiring	PSHU31L000P	PSHU31L001P

Accessories - 15407-1, Non plug-in, Size DX02

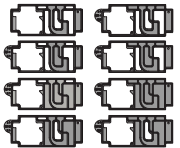
Accessories	Description	Part number		
	Gauge adapter kit Includes 1/8" coupling and long nipple	PS5651160P		
	Blanking plate kit	PS5634P		
	Sandwich flow control Do not use with Independent Port Sandwich Regulators.	PS5642P		
	Sandwich supply module	1/8" NPT	PS562600P	
		1/8" BSPP	PS562601P	
	Sandwich regulator	Common pressure	Independent pressure	
		2-60 PSIG w/ gauge	PS5637155P	PS5637255P
	Manifold to manifold gasket kits	5-125 PSIG w/ gauge	PS5637166P	PS5637266P
		Pilot open	Pilot blocked	
		#1, 3, 5 ports open	PSHU11P	PSHU15P
		Blocked #1 port	PSHU12P	PSHU16P
		Blocked #1, 3, 5, ports	PSHU13P	PSHU17P
	Blocked #3, 5 ports	PSHU14P	PSHU18P	

 Most popular.



For inventory, lead times, and kit lookup, visit www.pdnplu.com

D233

Parker Hannifin Corporation
 Pneumatic Division
 Richland, Michigan
www.parker.com/pneumatics

D

Subbase & Manual Valves

H Series Micro

Modulflex Series

H Series ISO





Network Connectivity

DX ISOMAX Series

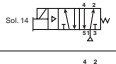

Valvair II Series

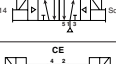
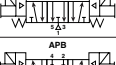
Common Part Numbers

DX01 ISO Solenoid Valves

Symbol	Type	Cv	Operator	Pilot	Override	24 VDC	120 VAC
	4-way, 2-position, spring return	0.75	Single solenoid	Internal	Non-locking	DX01-621-951M	DX01-621-951J
	4-way, 2-position, air return	0.75	Single solenoid	Internal	Non-locking	DX01-651-951M	DX01-651-951J
	4-way, 2-position	0.75	Double solenoid	Internal	Non-locking	DX01-606-951M	DX01-606-951J
	4-way, 3-position, center exhaust	0.5	Double solenoid	Internal	Non-locking	DX01-611-951M	DX01-611-951J
	4-way, 3-position, all ports blocked	0.5	Double solenoid	Internal	Non-locking	DX01-616-951M	DX01-616-951J

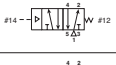
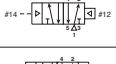
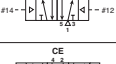

DX01 ISO Remote Pilot Valves

Symbol	Type	Cv	Operator	Pilot	Part Number
	4-way, 2-position, spring return	0.75	Single remote pilot	Remote	DX01-421-60
	4-way, 2-position, air return	0.75	Single remote pilot	Remote	DX01-451-60
	4-way, 2-position	0.75	Double remote pilot	Remote	DX01-406-60
	4-way, 3-position, center exhaust	0.5	Double remote pilot	Remote	DX01-411-60
	4-way, 3-position, all ports blocked	0.5	Double remote pilot	Remote	DX01-416-60

Torque Specifications

DX02: 15 to 25 in-lbs (1.69 to 2.82 Nm) DX01: 20 to 30 in-lbs (2.26 to 3.39 Nm)

Base / End Plate - 15407-1, Non Plug-in, Size DX01

	Description	NPT	BSPP
	Single subbase	Side ported base, 1/4" port PS5511130P	PS5511140P
	Universal manifold base	2 station, end ported PSHU115301P	PSHU115401P
	Universal end plate	Non-collective wiring PSHU31L000P	PSHU31L001P

 Most popular.



For inventory, lead times, and kit lookup, visit www.pdnplu.com





D234

Parker Hannifin Corporation
 Pneumatic Division
 Richland, Michigan
www.parker.com/pneumatics

D
 Subbase & Manual Valves
 H Series Micro
 Modulflex Series
 H Series ISO
 Network Connectivity
 DX ISOMAX Series
 Valvair-II Series

Common Part Numbers

Accessories - 15407-1, Non Plug-in, Size DX01

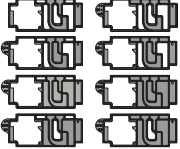
Accessories	Description	Part number	
	Blanking plate kit	PS5534P	
	Sandwich flow control	PS5542P	
	Sandwich Flow Control and Common Port Sandwich Regulator may be sandwiched together on a manifold or subbase. The Sandwich Flow Control MUST be located between the manifold/subbase and the Common Port Sandwich Regulator. Do not use with Independent Port Sandwich Regulators.		
	Pilot exhaust module	Pilot pressure control, without sensor, 1/8" BSPP PS55XA0P	
	Sandwich supply module	1/4" NPT	PS552600P
		1/4" BSPP	PS552601P
	Sandwich regulator	2-60 PSIG w/ gauge	PS5537155P
		5-125 PSIG w/ gauge	PS5537166P
		Common pressure	PS5537255P
		Independent pressure	PS5537266P
	Manifold to manifold gasket kits	Pilot open	Pilot blocked
		#1, 3, 5 ports open	PSHU11P
		Blocked #1 port	PSHU12P
		Blocked #1, 3, 5, ports	PSHU13P
		Blocked #3, 5 ports	PSHU14P
		PSHU15P	PSHU16P
		PSHU17P	PSHU18P

 Most popular.



For inventory, lead times, and kit lookup, visit www.pdnplu.com

D235

Parker Hannifin Corporation
 Pneumatic Division
 Richland, Michigan
www.parker.com/pneumatics

D

Subbase & Manual Valves

H Series Micro

Moduflex Series

H Series ISO

Network Connectivity

DX ISOMAX Series

Valvair II Series

Model Number

DX02 - 6 06 - 95 1 M

Basic Series	
ISO 15407-1 (18mm)	DX02
ISO 15407-1 (26mm)	DX01

Pilot	
Air Operated Remote Pilot	4
Solenoid Operated	6

Voltage & Frequency			
	AC		DC
	60Hz	50Hz	
J	120	110	
M			24
Blank	Remote Pilot		

Function	
Internal Pilot Supply / Captured Exhaust 12	
2-Position, Spring Return	21
2-Position, Air Return	51
2-Position	06
3-Position, CE	11
3-Position, APB	16
External Pilot 14 Supply / Captured Exhaust 12*	
2-Position, Spring Return	23
2-Position, Air Return	54
2-Position	05
3-Position, CE	09
3-Position, APB	19
Internal Pilot Supply / Vented Exhaust	
2-Position, Spring Return	20
2-Position, Air Return	50
2-Position	04
3-Position, CE	27
3-Position, APB	25
External Pilot Supply / Vented Exhaust*	
2-Position, Spring Return	22
2-Position, Air Return	53
2-Position	08
3-Position, CE	12
3-Position, APB	18

* Must be specified when using Sandwich Regulators.

Override	
Blank	Remote Pilot
1	Non-Locking, Flush
3	Locking, Flush

Operator	
60	None, Remote Pilot Valve
95	15mm, 3-Pin, DIN 43650C

D

Subbase & Manual Valves

H Series Micro

Modulflex Series

H Series ISO

Network Connectivity

DX ISOMAX Series

Valvair II Series

Note: DX02 18mm Valve Remote Pilot Option only available with PL02 Individual Subbase Kits



For inventory, lead times, and kit lookup, visit www.pdnplu.com

D236

Parker Hannifin Corporation
 Pneumatic Division
 Richland, Michigan
www.parker.com/pneumatics

Ordering Information

15407-1, DX02 & DX01 Manifold / Subbase Kits

PSHU1153 0 1 P

Mounting Style / Port Size	
DX02 manifold with 1/8 NPT end ports	PSHU1151
DX02 manifold with 1/8 BSPP end ports	PSHU1152*
DX01 manifold with 1/4 NPT end ports	PSHU1153
DX01 manifold with 1/4 BSPP end ports	PSHU1154*
DX1 manifold with 3/8 NPT end ports	PSHU1155
DX1 manifold with 3/8 BSPP end ports	PSHU1156*
DX2 manifold with 1/2 NPT end ports	PSHU1157
DX2 manifold with 1/2 BSPP end ports	PSHU1158*

* BSPP conforms to ISO 1179-1 w 228-1 threads.



DX01 manifold

Gasket Options	
1	1,3,5 ports open and pilots open
2	1,3,5 ports closed and pilots open
3	1 closed, 3,5 ports open and pilots closed
4	1 port open, 3,5 ports closed and pilots open
5	1,3,5 ports open and pilots closed
6	1,3,5 ports closed and pilots closed
7	1 closed, 3,5 ports open and pilots closed
8	1 port open, 3,5 ports closed and pilots open

Circuit Board Address Configuration	
0	No interconnect

Subbase Kit - Non Plug-in



HA non plug-in subbase shown

PS55 1113 0 P

Series	
DX01 Subbase	PS55
DX1 Subbase	PS40
DX2 Subbase	PS41

Engineering Level	
Blank	HA Series
D	H1 Series
C	H2 Series

Mounting Style / Port Size	
DX01 Series	
1/4 NPT side ports	1113
1/4 BSPP side ports	1114*
1/4 NPT bottom / side ports	1123
1/4 BSPP bottom / side ports	1124*
DX1 Series	
3/8 NPT side ports	1115
3/8 BSPP side ports	1116*
DX2 Series	
1/2 NPT side ports	1117
1/2 BSPP side ports	1118*

* BSPP conforms to ISO 1179-1 w 228-1 threads.

Enclosures / Lead Length	
0	None, No Electrical Plug

DX02 Series ISO 15407-1 Size 18mm (DX02) Single Subbase

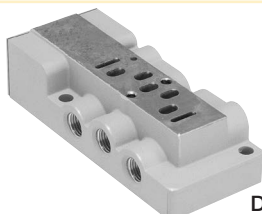

DX01 Series Subbase

Side ported base
18mm DX02 / HB

1/8" NPT	1/8" BSPP
PL02-01-80	PL02-01-70

Note: Can be used for external, single, or double remote pilot.



For inventory, lead times, and kit lookup, visit www.pdnplu.com

D237

Parker Hannifin Corporation
Pneumatic Division
Richland, Michigan
www.parker.com/pneumatics

D

Subbase & Manual Valves

H Series Micro

Moduflex Series

H Series ISO

Network Connectivity

DX ISOMAX Series

Valvair II Series

15407-1, DX02 & DX01 End Plate Kits



Left hand end plate

PSHU31 L0 0 0 P

Valve Type	
Non Plug-in (internal pilot)	PSHU31
Non Plug-in (external pilot)	PSHU3X

Left Hand End Plate Type	
Non Plug-in	L0

Thread Type	
0	NPT
1*	BSPP "G"

* BSPP Conforms to ISO 1179-1 w 228-1 Threads

Right Hand End Plate Type / Port	
0	Low profile (no ports)
1	1/2 Exhaust and inlet port
2	3/4 Exhaust and inlet port
5*	H3 Transition plate, 1" exhaust and inlet

* 1, 3 & 5 manifold galley blocked at transition plate. 12 & 14 pass through.

Right Hand End Plate



Low Profile

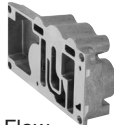

High Flow

Description	NPT port	BSPP port
Right hand end plate only, low profile	PSHU4000P	
Right hand end plate only, high flow 1/2" ports	PSHU4100P	PSHU4101P
Right hand end plate only, high flow 3/4" ports	PSHU4200P	PSHU4201P

H3 Transition Kit



Description	NPT port	BSPP port
H3 transition, H3 right hand end plate, 1" ports (includes gaskets & bolts)	PSU7300P	PSHU7301P

Manifold / Subbase Kit - Non Plug-in, 5599-1, Size 3 (H3)

PS421159 0 C P

Mounting Base Style / Port Size	
Subbase: 3/4 NPT side ports	PS421119
Subbase: 3/4 BSPP side port	PS421110*
Manifold: 3/4 NPT End port	PS421159
Manifold: 3/4 BSPP end port	PS421150*
Manifold: 3/4 NPT bottom / end port	PS421169
Manifold: 3/4 BSPP bottom / end port	PS421160*

* BSPP conforms to ISO 1179-1 w 228-1 threads.

Engineering Level	
C	H3

Enclosures / Lead Length	
0	None, No Electrical Plug - 5599-1



H3 Subbase shown



H3 Manifold shown



For inventory, lead times, and kit lookup, visit www.pdnplu.com

D238

Parker Hannifin Corporation
 Pneumatic Division
 Richland, Michigan
www.parker.com/pneumatics

D
 Subbase & Manual Valves
 H Series Micro
 Modulflex Series
 H Series ISO
 Network Connectivity
 DX ISOMAX Series
 Valvair II Series

Sandwich Regulators Features

- Remote Air Pilot Operated for hard-to-reach pressure control.
- Unregulated Pilot Pressure to valve for consistent valve shifting regardless of pressure adjustment.

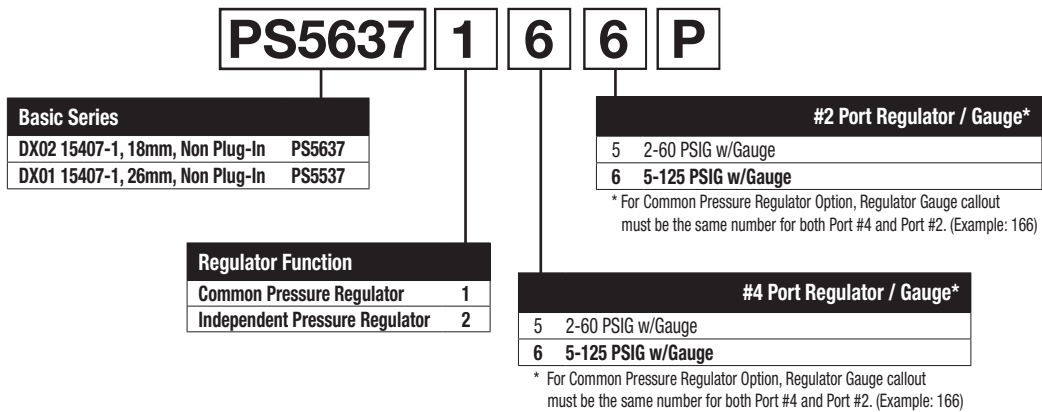

DX02
 (Independent Dual Port Regulator Shown)

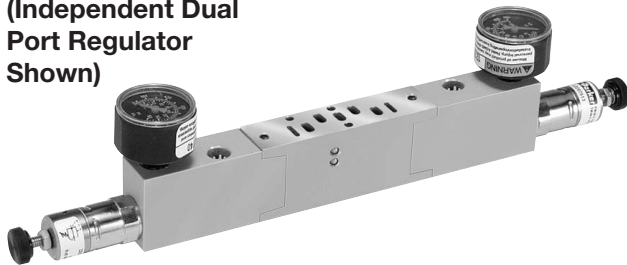

DX01
 (Common Port Regulator Shown)

Ordering Components

- Manifold or Subbase Kit required.
- Sandwich Regulator Kit configured for Internal Pilot as standard.
- Order valve as External Pilot.

How to Configure Sandwich Regulator / Valve Combinations

Internal Pilot Configuration of Sandwich Regulator HA, HB

Pressure in Base Port 1 feeds regulator configured for Internal Pilot which feeds valve configured for External Pilot.

Accessories	Description	Part number
 Gauge adapter kit	Includes 1/8" coupling, long nipple, and gauge	PS5651160P

Sandwich Regulator Cv Flow Chart*

	Common Pressure Code 166				Dual Pressure Code 266			
	1-2	1-4	2-3	4-5	1-2	1-4	2-3	4-5*
HB	0.20	0.20	0.41	0.34	0.23	0.19	0.28	0.27
HA	0.41	0.43	0.87	0.89	0.42	0.45	0.68	0.66

* Regulator Port exhaust through Base Port 3.
 Note: All Cv's calculated with regulator adjusted full open.

Remote Pilot Access Plate Kit

Size	Port size	Part number	
		NPT	BSPP
26mm DX01	1/8"	PS551500P	PS551501P



For inventory, lead times, and kit lookup, visit www.pdnplu.com

D239

Parker Hannifin Corporation
 Pneumatic Division
 Richland, Michigan
www.parker.com/pneumatics

D

Subbase & Manual Valves

H Series Micro

Modulflex Series

H Series ISO

Network Connectivity

DX ISOMAX Series

Valvair II Series

DX02 Series Subbase & Manifolds

Single Subbase

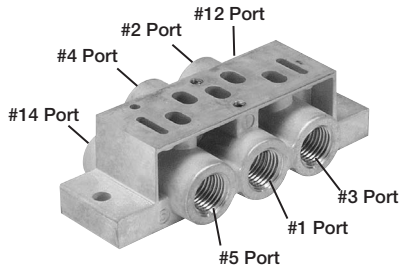

Side Ported Base
 18mm DX02

1/8" NPT	1/8" BSPP
PL02-01-80	PL02-01-70

Note: Can be used for external, single, or double remote pilot.

2 Station Manifold Bases

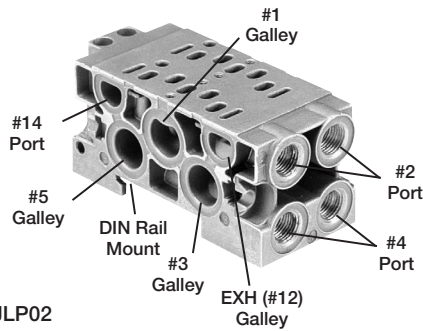

End Ported Bases
 18mm DX02

1/8" NPT	1/8" BSPP
PJLP02-201-80	PJLP02-201-70

Note: Can be used for external pilot, not remote pilot. Gaskets and assembly hardware included.

PJLP02

End Plate Kit

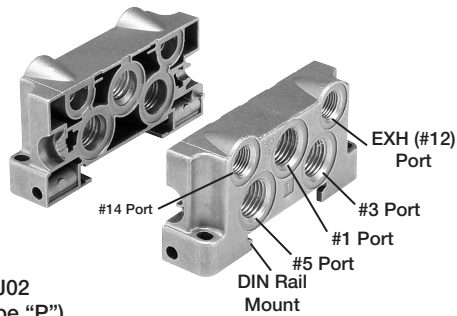

Side Ported Two Station
 Manifold Base
 18mm DX02

1/4" NPT Port	1/4" BSPP Port
PEJ02-02-80*	PEJ02-02-70

***Note:** Put a vent or muffler in "EXH" port when capturing pilot exhaust pressure with a solenoid valve. (See gasket selector page for details.) Gaskets and assembly hardware included.
 Torque Specifications: 25 to 35 in-lbs (2.82 to 3.95 Nm)

PEJ02
 (Type "P")

D
 Subbase & Manual Valves
 H Series Micro
 Modulflex Series
 H Series ISO
 Network Connectivity
 DX ISOMAX Series
 Valvair II Series

Most popular.



For inventory, lead times, and kit lookup, visit www.pdnplu.com

DX01 Series Subbase & Manifolds

Single Subbase

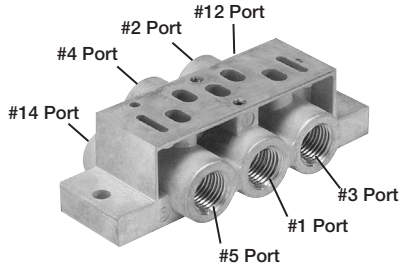

Side ported base
26mm DX01

Part number

1/4" NPT	1/4" BSPP
PL01-02-80	PL01-02-70

Note: Can be used for external, single, or double remote pilot.

2 Station Manifold Bases

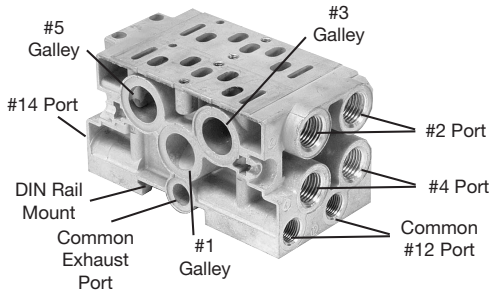

End ported bases
26mm DX01

1/4" NPT	1/4" BSPP
PJLP01-202-80	PJLP01-202-70

Note: Can be used for single remote pilot using the #14 Port and external pilot. Gaskets and assembly hardware included.

PJLP01

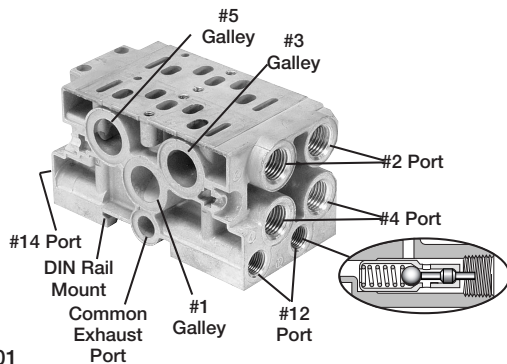

End ported bases
26mm DX01

1/4" NPT	1/4" BSPP
PJL01-202-80	PJL01-202-70

Notes: #12 ports work independently when plunger is not depressed by a plug. When a plug is inserted in #12 Port along with the captured pilot exhaust gasket selector option, pilot exhaust is sent to the Common Exhaust Port. Do Not plug exhaust, insert a vent of muffler.

Gaskets and assembly hardware included. Can be used for external, single or double remote pilot.

PJL01

End Plate Kit

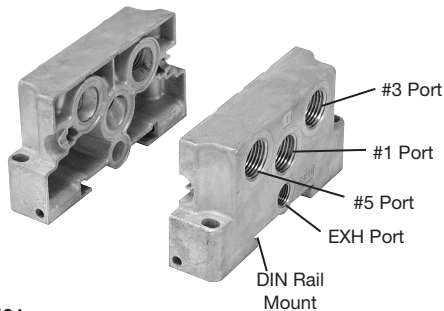

Side ported two station manifold base
26mm DX01

3/8 NPT port	3/8 BSPP port
PEJ01-03-80*	PEJ01-03-70

* Use with PJLP01 or PJL01

Notes: Put a vent or muffler in "EXH" port when capturing pilot exhaust pressure with a solenoid valve. (See gasket selector page for details.) Gaskets and assembly hardware included. Torque Specifications: 25 to 35 in-lbs (2.82 to 3.95 Nm)

PEJ01

Most popular.



For inventory, lead times, and kit lookup, visit www.pdnplu.com

D241

Parker Hannifin Corporation
Pneumatic Division
Richland, Michigan
www.parker.com/pneumatics

D

Subbase & Manual Valves

H Series Micro

Moduflex Series

H Series ISO

Network Connectivity

DX ISOMAX Series

Valvair II Series

Accessories

Intermediate Air Supply Base



Size	Port size	Part number
18mm DX02	1/8" NPT	D02P-01-80
26mm DX01	1/4" NPT	D01P-02-80

Notes: Gasket & Mounting Bolts included.
Torque Specifications
Size 02: 15 to 25 in-lbs (1.69 to 2.82 Nm)
Size 01: 20 to 30 in-lbs (2.26 to 3.39 Nm)

Manifold Port Isolation Disc

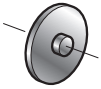

Size		Part number
18mm DX02	Common Pressure	D02BD0
26mm DX01	Common Pressure	D01BD0

Notes: 3 Discs per Kit.
Used on PJJ Manifolds.

Blanking Plate



Size		Part number
18mm DX02	Common Pressure	PS5634P
26mm DX01	Common Pressure	PS5534P

Notes: Gasket & Mounting Bolts included.
Torque Specifications
Size 02: 15 to 25 in-lbs (1.69 to 2.82 Nm)
Size 01: 20 to 30 in-lbs (2.26 to 3.39 Nm)

Sandwich Flow Control Features



DX02
18mm Shown

Size	Part number
18mm DX02	PS5642P
26mm DX01	PS5542P

- Both adjustment screws are located on the 12 end of the unit.
- Sandwich Flow Control mounts with its own studs, which means the valve uses standard bolts for mounting.
- Sandwich Flow Control is not to be used as a shut off device and is not bubble tight when needles are fully turned down.
- Do not use with Independent Port Sandwich Regulators.

Manifold to Manifold Gasket Kits



DX02M2MGSKT (PJLP02)



DX01M2MGSKT (PJLP01)

Size	Standard	Blocked #1 Port	Blocked #1, 3, 5 Ports	Blocked #3, 5 Ports
DX02*	PS561AP	PS561BP	PS561CP	PS561DP
DX01*				

DX02 **DX02M2MGSKT (PJLP02)**

DX01 **DX01M2MGSKT (PJLP01)**

* Gaskets used with PS5611 & PS5511 Manifolds.

Manifold Hardware Kits

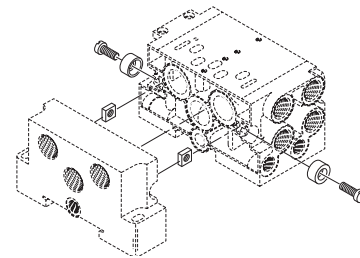

Description	Part number
Bolt, Washer & Nut*	DX02M2MB**
Tie Rods for PS5611 Manifold (Qty. 12)	PS5612P
Tie Rods for PS5511 Manifold (Qty. 12)	PS5512P

* Includes 10 Bolts, 10 Washers, 10 Nuts

** Use this number for both sizes, PJLP02 & PJLP01.

Torque Specifications: 25 to 35 in-lbs (2.82 to 3.95 Nm)

D
 Subbase & Manual Valves
 H Series Micro
 Modulflex Series
 H Series ISO
 Network Connectivity
 DX ISOMAX Series
 Valvair II Series



For inventory, lead times, and kit lookup, visit www.pdnplu.com

Common Part Numbers

DX1 ISO Solenoid Valves

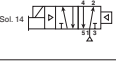
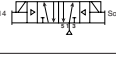
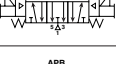
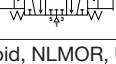

Symbol	Type	Cv	Operator	Pilot	Override	24 VDC	120 VAC
	4-way, 2-position, spring return	1.15	Single solenoid	Internal	Non-locking	DX1-621-BL49	DX1-621-BL53
					Locking	DX1-621-CL49	DX1-621-CL53
	4-way, 2-position, air return	1.15	Single solenoid	Internal	Non-locking	DX1-651-BL49	DX1-651-BL53
					Locking	DX1-651-CL49	DX1-651-CL53
	4-way, 2-position	1.15	Double solenoid	Internal	Non-locking	DX1-606-BL49	DX1-606-BL53
					Locking	DX1-606-CL49	DX1-606-CL53
	4-way, 3-position, center exhaust	0.75	Double solenoid	Internal	Non-locking	DX1-611-BL49	DX1-611-BL53
					Locking	DX1-611-CL49	DX1-611-CL53
	4-way, 3-position, all ports blocked	0.75	Double solenoid	Internal	Non-locking	DX1-616-BL49	DX1-616-BL53
					Locking	DX1-616-CL49	DX1-616-CL53

30mm 3-Pin Solenoid, NLMOR, Unlighted, Internal Pilot, Valve Less Base

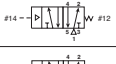
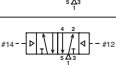
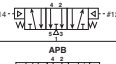

DX1 ISO Remote Pilot Valves

Symbol	Type	Cv	Operator	Pilot	Part Number
	4-way, 2-position, spring return	1.15	Single remote pilot	Remote	DX1-421-60
					DX1-451-60
	4-way, 2-position, air return	1.15	Single remote pilot	Remote	DX1-406-60
					DX1-411-60
	4-way, 3-position, center exhaust	0.75	Double remote pilot	Remote	DX1-416-60
					DX1-416-60

Base / End Plate - 5599-1, Non Plug-in, Size 1 DX1

	Description	NPT	BSPP
 Single subbase	Side ported, 3/8" port	PS4011150DP	PS4011160DP
 Universal manifold base	End ported	PSHU115501P	PSHU115601P
 Universal end plate	Non-collective wiring	PSHU31L000P	PSHU31L001P

Accessories - 5599-1, Non Plug-in, Size 1 DX1

Accessory	Description	Part number
 Sandwich regulator	Common pressure	5-125 PSIG w/ gauge PS4037166CP
	Independent pressure	5-125 PSIG w/ gauge PS4037266CP
 Blanking plate kit		PS4034CP
 Sandwich flow control		PS4042CP

Sandwich Flow Control and Common Port Sandwich Regulator may be sandwiched together on a manifold or subbase. The Sandwich Flow Control MUST be located between the manifold/subbase and the Common Port Sandwich Regulator. Do not use with Independent Port Sandwich Regulators.

 Most popular.



For inventory, lead times, and kit lookup, visit www.pdnplu.com

D243

Parker Hannifin Corporation
 Pneumatic Division
 Richland, Michigan
www.parker.com/pneumatics

D

Subbase & Manual Valves

H Series Micro

Modulflex Series

H Series ISO



Network Connectivity

DX ISOMAX Series

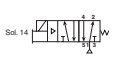

Valvair II Series

Common Part Numbers

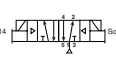
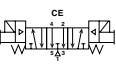
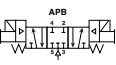

DX2 ISO Valves

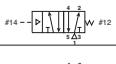
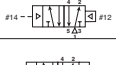
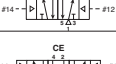
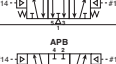
Symbol	Type	Cv	Operator	Pilot	Override	24 VDC	120 VAC
	4-way, 2-position, spring return	2.5	Single solenoid	Internal	Non-locking	DX2-621-BL49	DX2-621-BL53
					Locking	DX2-621-CL49	DX2-621-CL53
	4-way, 2-position, air return	2.5	Single solenoid	Internal	Non-locking	DX2-651-BL49	DX2-651-BL53
					Locking	DX2-651-CL49	DX2-651-CL53
	4-way, 2-position	2.5	Double solenoid	Internal	Non-locking	DX2-606-BL49	DX2-606-BL53
					Locking	DX2-606-CL49	DX2-606-CL53
	4-way, 3-position, center exhaust	2.4	Double solenoid	Internal	Non-locking	DX2-611-BL49	DX2-611-BL53
					Locking	DX2-611-CL49	DX2-611-CL53
	4-way, 3-position, all ports blocked	2.4	Double solenoid	Internal	Non-locking	DX2-616-BL49	DX2-616-BL53
					Locking	DX2-616-CL49	DX2-616-CL53



DX2 ISO Remote Pilot Valves

Symbol	Type	Cv	Operator	Pilot	Part Number
	4-way, 2-position, spring return	2.5	Single remote pilot	Remote	DX2-421-60
	4-way, 2-position, air return	2.5	Single remote pilot	Remote	DX2-451-60
	4-way, 2-position	2.5	Double remote pilot	Remote	DX2-406-60
	4-way, 3-position, center exhaust	2.4	Double remote pilot	Remote	DX2-411-60
	4-way, 3-position, all ports blocked	2.4	Double remote pilot	Remote	DX2-416-60

Base / End Plate - 5599-1, Non Plug-in, Size 2 DX2

	Description	1/2" NPT	1/2" BSPP	
	Single subbase	Side ported, 1/2" port	PS4111170CP	PS4111180CP
	Universal manifold base	End ported	PSHU115701P	PSHU115801P
	Universal end plate	Non-collective wiring	PSHU31L000P	PSHU31L001P

Accessories - 5599-1, Non Plug-in, Size 2 DX2

Accessory	Description	Part number
	Common pressure	5-125 PSIG w/ gauge PS4137166CP
	Independent pressure	5-125 PSIG w/ gauge PS4137266CP
	Blanking plate kit	PS4134CP
	Sandwich flow control	PS4142CP
Sandwich Flow Control and Common Port Sandwich Regulator may be sandwiched together on a manifold or subbase. The Sandwich Flow Control MUST be located between the manifold/subbase and the Common Port Sandwich Regulator. Do not use with Independent Port Sandwich Regulators.		

 Most popular.

D
 Subbase & Manual Valves
 H Series Micro
 Modulflex Series
 H Series ISO
 Network Connectivity
 DX ISOMAX Series
 Valvair II Series





For inventory, lead times, and kit lookup, visit www.pdnplu.com

D244

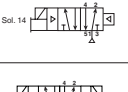

Parker Hannifin Corporation
 Pneumatic Division
 Richland, Michigan
www.parker.com/pneumatics

Common Part Numbers

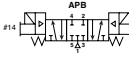

DX3 ISO Valves

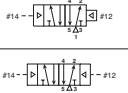
Symbol	Type	Cv	Operator	Pilot	Override	24 VDC	120 VAC
 Sol. 14	4-way, 2-position, spring return	4.15	Single solenoid	Internal	Non-locking	DX3-621-BL49	DX3-621-BL53
					Locking	DX3-621-CL49	DX3-621-CL53
 Sol. 14	4-way, 2-position, air return	4.15	Single solenoid	Internal	Non-locking	DX3-651-BL49	DX3-651-BL53
					Locking	DX3-651-CL49	DX3-651-CL53
 Sol. 14	4-way, 2-position	4.15	Double solenoid	Internal	Non-locking	DX3-606-BL49	DX3-606-BL53
					Locking	DX3-606-CL49	DX3-606-CL53
 Sol. 14	4-way, 3-position, center exhaust	4.0	Double solenoid	Internal	Non-locking	DX3-611-BL49	DX3-611-BL53
					Locking	DX3-611-CL49	DX3-611-CL53
 Sol. 14	4-way, 3-position, all ports blocked	4.0	Double solenoid	Internal	Non-locking	DX3-616-BL49	DX3-616-BL53
					Locking	DX3-616-CL49	DX3-616-CL53

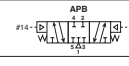
DX3 ISO Remote Pilot Valves

Symbol	Type	Cv	Operator	Pilot	Part Number
 #14	4-way, 2-position, spring return	4.15	Single remote pilot	Remote	DX3-421-60
					DX3-451-60
 #14	4-way, 2-position, air return	4.15	Single remote pilot	Remote	DX3-406-60
					DX3-411-60
 #14	4-way, 3-position, center exhaust	4.0	Double remote pilot	Remote	DX3-416-60
					DX3-421-60
 #14	4-way, 3-position, all ports blocked	4.0	Double remote pilot	Remote	DX3-416-60
					DX3-421-60

DX3 Series Subbase & Manifolds

Single subbase	Description	3/4" NPT	3/4" BSPP
	Side ported base	PS4211190CP	PS4211100CP
Manifold bases	Description	3/4" NPT	3/4" BSPP
	Bottom / End ported bases Note: Manifolds include 2 pipe plugs	PS4211690CP	PS4211600CP
End plate kits	Description	NPT port	BSPP port
	H3 Non-collective wiring end plates	PS4231010DP	PS4231011DP

5599-1, DX3 Accessories

Accessories	Description	Part Number
Sandwich regulator 	Common pressure 5-125 PSIG w/ gauge	PS4237166CP
	Independent pressure 5-125 PSIG w/ gauge	PS4237266CP
Manifold to manifold gasket kit		PS4213P

 Most popular.



For inventory, lead times, and kit lookup, visit www.pdnplu.com

D245

Parker Hannifin Corporation
 Pneumatic Division
 Richland, Michigan
www.parker.com/pneumatics

D

Subbase & Manual Valves

H Series Micro

Modulflex Series

H Series ISO

Network Connectivity

DX ISOMAX Series

Valvair II Series

DX1

6 21

B L 53

Basic Series	
ISO 5599-1	DX1 - Size 1
ISO 5599-1	DX2 - Size 2
ISO 5599-1	DX3 - Size 3

Pilot	
Air Operated Remote Pilot	4
Solenoid Operated	6

Voltage & Frequency			
	AC		DC
	60Hz	50Hz	
19*			24
49			24
53	120	110	
Blank	Remote Pilot or Valve Less Coil		

* LED & Surge Suppression.
 Only Available with Enclosure "6".

Function	
Internal Pilot Supply	
2-Position, Spring Return, Air Assist	21
2-Position, Diff Return	51
2-Position	06
3-Position, CE	11
3-Position, APB	16
3-Position, PC	13*
External Pilot Supply†	
2-Position, Spring Return, Air Assist	22
2-Position, Diff Return	53
2-Position	08
3-Position, CE	12
3-Position, APB	18
3-Position, PC	24*

* Not offered with DX3 Valves.
 † Must be specified when using Sandwich Regulators.

5599-1 Enclosure / Lead Length / Light	
0**	None, Remote Pilot Valve
6*	2-Pin, M12 EURO Connector with CNOMO Operator, Light
L	3-Pin, 30mm DIN 43650A with CNOMO Connector, No Light
P	3-Pin, 22mm Industrial with CNOMO Connector, No Light
N†	None, Valve Less Coil, No Light

* Only available with Voltage & Frequency "19".

**Must use Overrides Option "6".

† Must use Overrides Option "B" or "C".

5599-1 Overrides	
6	Remote Pilot / Without Solenoid
B	Non-Locking, Flush, Push
C	Locking, Flush, Push / Turn

D

Subbase & Manual Valves

H Series Micro

Modulflex Series

H Series ISO

Network Connectivity

DX ISOMAX Series

Valvair II Series



For inventory, lead times, and kit lookup, visit www.pdnplu.com

Non-Plug-in, 5599-1, End Plate Kits

PS423101 0 C P

Basic Series	
ISO 5599, Size 3	PS423101

Thread Type	
0	NPT
1*	BSPP "G"

* BSPP Conforms to ISO 1179-1 w 228-1 Threads.

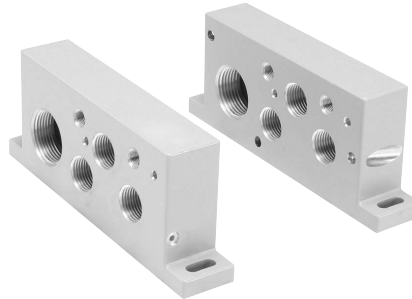

H1 Non-Collective Wiring End Plates

D

Subbase & Manual Valves

H Series Micro

Moduflex Series

H Series ISO

Network Connectivity

DX ISOMAX Series

Valvair II Series



For inventory, lead times, and kit lookup, visit www.pdnplu.com

D247

Parker Hannifin Corporation
 Pneumatic Division
 Richland, Michigan
www.parker.com/pneumatics

Ordering Information

Sandwich Regulators Features

- Remote Air Pilot Operated for hard-to-reach pressure control.
- Unregulated Pilot Pressure to valve for consistent valve shifting regardless of pressure adjustment.

PS4037 1 6 6 C P

Basic Series	
H1 5599-1, Non Plug-in	PS4037
H2 5599-1, Non Plug-in	PS4137

Regulator Function	
Common Pressure Regulator	1
Independent Pressure Regulator	2

#2 Port Regulator / Gauge*	
0**	Line By-Pass Plate
4	1-30 PSIG w/Gauge
5	2-60 PSIG w/Gauge
6	5-125 PSIG w/Gauge
D	Remote Pilot ISO 2 & 3 only

* For common pressure regulator option, regulator gauge callout must be the same number for both Port #4 and Port #2. (Example: 166)

** Pressure Line by-pass option can only be used with independent pressure regulators.

#4 Port Regulator / Gauge*	
0**	Line By-Pass Plate
4	1-30 PSIG w/Gauge
5	2-60 PSIG w/Gauge
6	5-125 PSIG w/Gauge
D	Remote Pilot ISO 2 & 3 only

* For common pressure regulator option, regulator gauge callout must be the same number for both Port #4 and Port #2. (Example: 166)

** Pressure Line by-pass option can only be used with independent pressure regulators.

D
 Subbase & Manual Valves
 H Series Micro
 Moduteflex Series
 H Series ISO
 Network Connectivity
 DX ISOMAX Series
 Valvair II Series

DX1 - Size 1
 (Independent Dual Port Regulator Shown)



DX2 - Size 2
 (Independent Dual Port Regulator Shown)

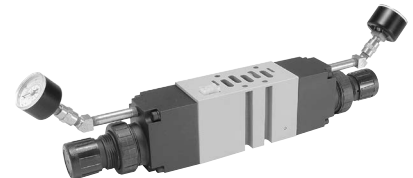

Ordering Components

- Manifold or Subbase Kit required.
- Sandwich Regulator Kit configured for Internal Pilot as standard.
- Order valve as External Pilot.

How to Configure Sandwich Regulator / Valve Combinations

Internal Pilot Configuration -

Pressure in Base Port 1 feeds regulator configured for Internal Pilot which feeds valve configured for External Pilot.

External Pilot Configuration - DX1, DX2, DX3

An External Pilot pressure in Port 12 or 14 of the base feeds thru the Sandwich Regulator 12 or 14 galley directly to the 12/14 pilot of the valve. This configuration takes an External Pilot from the 12 port of the base and passes it thru the regulator to feed the 12 galley of the valve.

Note: Do not use Independent Port Sandwich Regulators with Sandwich Flow Controls.

Independent Port Sandwich Port Regulators combine the #3 and #5 valve exhaust ports into the #5 exhaust at the manifold/subbase interface. The #3 port flow control will control both #3 and #5 exhaust. #5 port flow control is ineffective.

Sandwich Regulator Cv Flow Chart*

	Common Pressure Code 166				Single Pressure 2 Code 206				Single Pressure 4 Code 260				Dual Pressure Code 266			
	1-2	1-4	2-3	4-5	1-2	1-4	2-3	4-5*	1-2	1-4	2-3	4-5*	1-2	1-4	2-3	4-5*
H1	0.62	0.61	1.28	1.18	0.73	0.96	0.96	0.93	0.34	0.70	0.94	0.98	0.52	0.48	0.86	0.88
H2	1.47	1.60	2.41	2.33	1.71	1.90	1.52	1.75	1.74	1.67	1.73	1.79	1.61	1.62	1.50	1.67

* Regulator Port exhaust through Base Port 3.

Note: All Cv's calculated with regulator adjusted full open.

Most popular.





For inventory, lead times, and kit lookup, visit www.pdnplu.com

D248

Parker Hannifin Corporation
 Pneumatic Division
 Richland, Michigan
www.parker.com/pneumatics

5599-1 Compact Manifolds, Subbases & Accessories

Manifold VDMA – Form C			Part Number	
	Bottom Port	Size	Port size	
		DX1	1/4"	BSPP G
		DX2	3/8"	P2N-VM512MB
		DX3	1/2"	P2N-WM513MB
			P2N-YM514MB	

VDMA End Plates – Form D			Part Number
	Size	Port size	BSPP G
	DX1	3/8"	P2N-VM513ES
	DX2	1/2"	P2N-WM514ES
	DX3	1"	P2N-YM518ES

Subbase – Side Ports (5599-1 & VDMA)	Size	Port Size	5599-1 Part Number		VDMA Part Number
			NPT	BSPP “G”	BSPP “G”
	DX1	1/4"	PL1-1/4-80	PL1-1/4-70	P2N-VS512SD
	DX2	3/8"	PL2-3/8-80	PL2-3/8-70	P2N-WS513SD
	DX3	1/2"	PL3-1/2-80	PL3-1/2-70	P2N-YS514SD

Subbase – Bottom Ports	Size	Port size	5599-1 Part Number	
			NPT	BSPP “G”
	DX1	1/4"	PD1-1/4-80	PD1-1/4-70
	DX2	3/8"	PD2-3/8-80	PD2-3/8-70

VDMA Transition Plate	Part Number
 <small>DX1 (Not Included)</small> <small>Transition Plate</small> <small>DX3 (Not Included)</small>	P2N-VM500AK
	Kit includes: <u>Transition Plate Only</u> . Order P2N-VM513ES and P2N-YM518ES Separately to Assemble Add-A-Fold

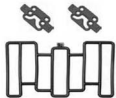
External Seal Kit	Size	Part Number
	DX1	JJDX10-A
	DX2	JJDX20-A
	DX3	JJDX30-A

Complete Seal Kit	Size	Part Number
	DX1	JJDX15-A
	DX2	JJDX25-A
	DX3	JJDX35-A

D

Subbase & Manual Valves

H Series Micro

Modulflex Series

H Series ISO

Network Connectivity

DX ISOMAX Series

Valvair II Series



For inventory, lead times, and kit lookup, visit www.pdnplu.com

Accessories

Blanking Plate Kits



Size	Part Number
DX1	PS4034CP
DX2	PS4134CP
DX3	PS4234CP

Kit includes:
Blanking Plate, Gasket, and Mounting Bolts.

Remote Pilot Access Plate Kits

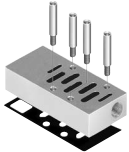

Size	Port Size	BSPP "G"
DX1	1/8"	PS401501CP
DX2	1/8"	PS411501CP
DX3	1/8"	PS421501CP

Kit includes: Pilot Port Access Plate, Gasket and Mounting Studs.

Manifold Port Isolation Kits

Main Galley (1, 3, 5)

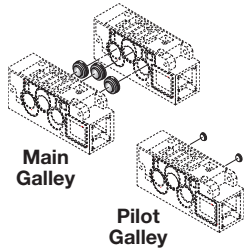

Size	P2N Manifolds
DX1	P2N-VK0P
DX2	P2N-WK0P
DX3	P2N-YK0P

Kit includes: Plugs with O-rings.

Pilot Galley

Size	Part Number
DX3	PS4033CP

Kit includes: Plugs with O-rings.
For use with PS4 Series Manifolds.

Sandwich Flow Controls Features



Size	Part Number
DX1	PS4042CP
DX2	PS4142CP
DX3	PS4242CP

- Both adjustment screws are located on the 12 end of the unit.
- Sandwich Flow Control mounts with its own studs, which means the valve uses standard bolts for mounting.
- Sandwich Flow Control is not to be used as a shut off device and is not bubble tight when needles are fully turned down.
- Do not use with Independent Port Sandwich Regulators.

22mm Rectangular 3-Pin – Type B Industrial

(Use with Enclosure "B")

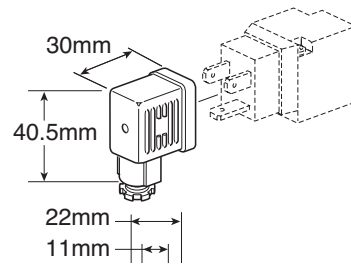

Description	Connector	Connector with 6' (2m) Cord
Unlighted	PS2429BP	PS2429JBP
Light – 24V/60Hz, 24VDC	PS243079BP	PS2430J79BP*
Light – 120V/60Hz	PS243083BP	PS2430J83BP*
Light – 240V/60Hz	PS243087BP	N/A

* LED with surge suppression.

Note: Max ϕ 6.5mm cable size required for connector w/o 6' (2m) cord. IP65 rated when properly installed.

Engineering Data:

Conductors: 2 Poles Plus Ground; Cable Range (Connector Only): 6 to 8mm (0.24 to 0.31 Inch); Contact Spacing: 11mm

CNOMO Operator Adapter



Size	Part Number
DX1, DX2, DX3	PS2855P

D
 Subbase & Manual Valves
 H Series Micro
 Modulflex Series
 H Series ISO
 Network Connectivity
 DX ISOMAX Series
 Valvair II Series



For inventory, lead times, and kit lookup, visit www.pdnplu.com

15mm 3-Pin DIN 43650C Replacement Solenoid Kits

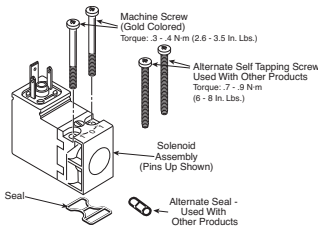

Voltage	Non-Locking	Locking
24VDC	PS2982B49P	PS2982C49P
110/50, 120/60	PS2982B53P	PS2982C53P

15mm 3-Pin DIN 43650C Connectors

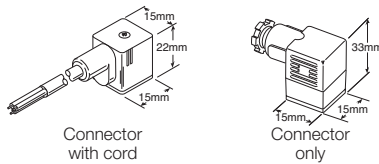

Description	Connector with 6' (2m) Cord	Connector
No circuit board	PS2932JBP	PS2932BP
Light - 24DC	PS2946J79BP*	PS294679BP
Light - 110/120VAC	PS2946J83BP*	PS294683BP

* LED with surge suppression.

Note: Max. ø6.5mm cable size required for connector without 6' (2m) cord. IP65 rated when properly installed.

Engineering Data:

Conductors: 2 poles plus ground
 Cable range (Connector only): 4 to 6mm (0.16 to 0.24 Inch)
 Contact spacing: 8mm

Female Electrical Connectors (IP65 Rated) 30mm, 3-Pin ISO 4400, (DIN 43650A)

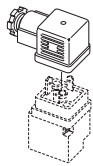

Description	Connector with 6' (2m) cord	Connector
Unlighted	PS2028JCP	PS2028BP
Light - 6-48V, 50/60Hz; 6-48VDC	PS2032J79CP*	PS203279BP
Light - 120V/60Hz	PS2032J83CP*	PS203283BP
Light - 240V/60Hz	N/A	PS203283BP

* With surge suppression.

Engineering data:

Conductors: 2 poles plus ground; cable range (connector only): 8 to 10mm (0.31 To 0.39 inch); Contact spacing: 18mm

5599-1 CNOMO Solenoid Kits

Voltage Code	3-pin, 30mm 'L' Coil Kit	2-pin, M12 Euro '6' coil Kit
19	—	PS2828619P
42	P2FCA442	—
45	P2FCA445	—
49	P2FCA449	—
53	P2FCA453	—
57	P2FCA457	—

Quantity 1

Pilot Operator - CNOMO

Valve size	Kit Number
DX1, DX2 & DX3	Locking PS4052CP
	Non-locking PS4053CP



For inventory, lead times, and kit lookup, visit www.pdnplu.com

D251

Parker Hannifin Corporation
 Pneumatic Division
 Richland, Michigan
www.parker.com/pneumatics

D

Subbase & Manual Valves

H Series Micro

Moduflex Series

H Series ISO

Network Connectivity

DX ISOMAX Series

Valvair II Series

Ceramic Technology / Valve Specifications

- Subbase Mounted Valves Conforming to ISO Standard 5599/1
- High Flow: DX1 (1.15 Cv), DX2 (2.50 Cv), DX3 (4.15 Cv)
- Air or Solenoid Operation Using CNOMO Solenoids
- Can Be Vacuum Operated

Air Condition:

Filtered to 40µ

Dual Pressure Supply from Exhaust Ports:

Yes - Without additional pressure at 12 and 14

Dust and Water Protection:

IP65 (According to EN 60529)

Mechanical Life:

> 100 million operations (Dry air filtered 40 µ, 2 Hz, 6 bar, 20°C)

Media:

Air or inert gas, filtered 40 µ (Class 5 according to ISO 8573-1), lubricated or non-lubricated

Operating Temperature Range:

-10°C to 60°C (14°F to 140°F)

Flow Rating (Cv)

Size	Port Size	Mounting Style	Flow Rating (Cv)	
			2-Position	3-Position
DX1	1/4" Ports	Subbase	1.15	0.75
	1/4" Ports	Manifold	0.80	0.60
DX2	3/8" Ports	Subbase	2.50	2.40
	3/8" Ports	Manifold	2.05	1.95
DX3	1/2" Ports	Subbase	4.15	4.00
	1/2" Ports	Manifold	4.10	3.65

Cv tested per ANSI / (NFPA) T3.21.3

Flow Rating (Cv) with Sandwich Regulator

Size	Common Pressure				Dual Pressure			
	1-2	1-4	2-3	4-5	1-2	1-4	2-3	4-5
DX1	0.55	0.49	1.06	1.02	0.32	0.42	0.25	0.38
DX2	1.06	1.05	2.33	2.17	0.93	0.66	0.77	1.15

Note: All Cv's calculated with regulator adjusted full open.

Response Time**

Single Solenoid 2-Position -
 Air Return / Spring Assist

Size	Port Size	0 Cu. In. Chamber		## Cu. In. Chamber	
		Fill	Exhaust	Fill	Exhaust
DX1	1/4"	.025	.030	.160	.235
DX2	3/8"	.040	.045	.170	.235
DX3	1/2"	.060	.065	.245	.330

DX1 (50), DX2 (100), DX3 (200)

** With 100 PSIG supply, time required to fill from 0 to 90 PSIG and Exhaust from 100 PSIG to 10 PSIG measured from the instant of energizing or de-energizing 24VDC solenoid.

Tested per ANSI / (NFPA) T3.21.8

Solenoid Information

Code	Voltage			Power (W / VA)
	AC			
	60Hz	50Hz	DC	
19	—	—	24	2.8W
49	—	—	24	2.7W
53	120	115	—	3.7VA

Data tested with LED and Surge Suppression.

Operating Pressure

Vacuum to 145 PSIG (10 bar)

Function	M.O.P. (PSIG)		
	DX1	DX2	DX3
Internal Pilot			
21 2-Position, Spring Return	36	30	30
51 2-Position, Air Return	30	30	30
06 2-Position	15	15	15
11 3-Position, CE	45	36	36
16 3-Position, APB	45	36	36
13 3-Position, PC	45	36	—
External Pilot			
22 2-Position, Spring Return	36	30	30
53 2-Position, Air Return	30	30	30
08 2-Position	15	15	15
12 3-Position, CE	45	36	36
18 3-Position, APB	45	36	36
24 3-Position, PC	45	36	—

D
 Subbase & Manual Valves
 H Series Micro
 Modulflex Series
 H Series ISO
 Network Connectivity
 DX ISOMAX Series
 Valvair II Series



For inventory, lead times, and kit lookup, visit www.pdnplu.com

DX ISOMAX Selector Gasket Conversion Instructions

Changing from Internal to External Pilot Supply

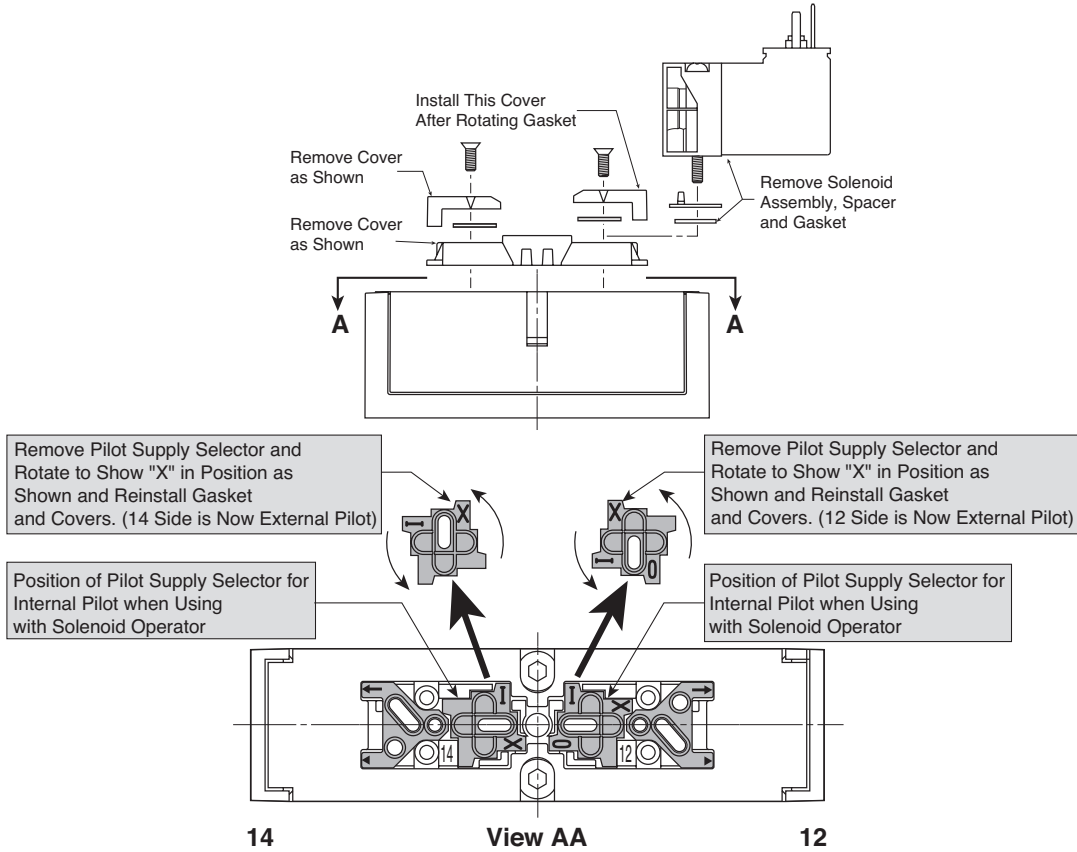

Changing from External Pilot Supply, Vented Pilot Exhaust to Internal Pilot Supply, Captured Pilot Exhaust

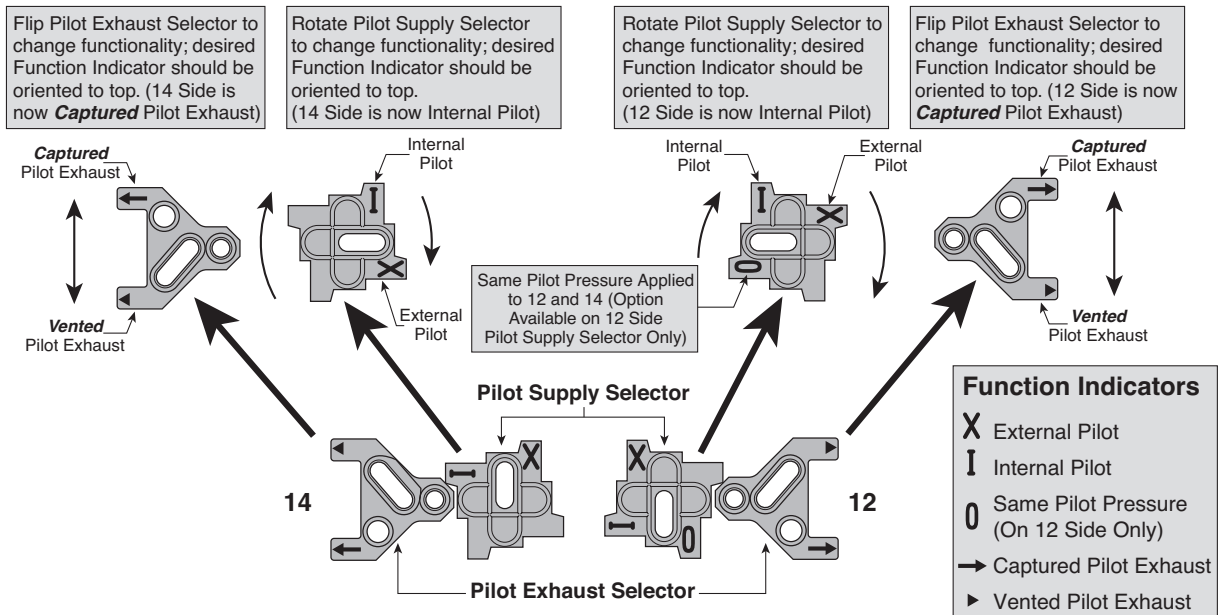

D	Subbase & Manual Valves
H Series Micro	Modulflex Series
H Series ISO	Network Connectivity
DX ISOMAX Series	Valvair II Series

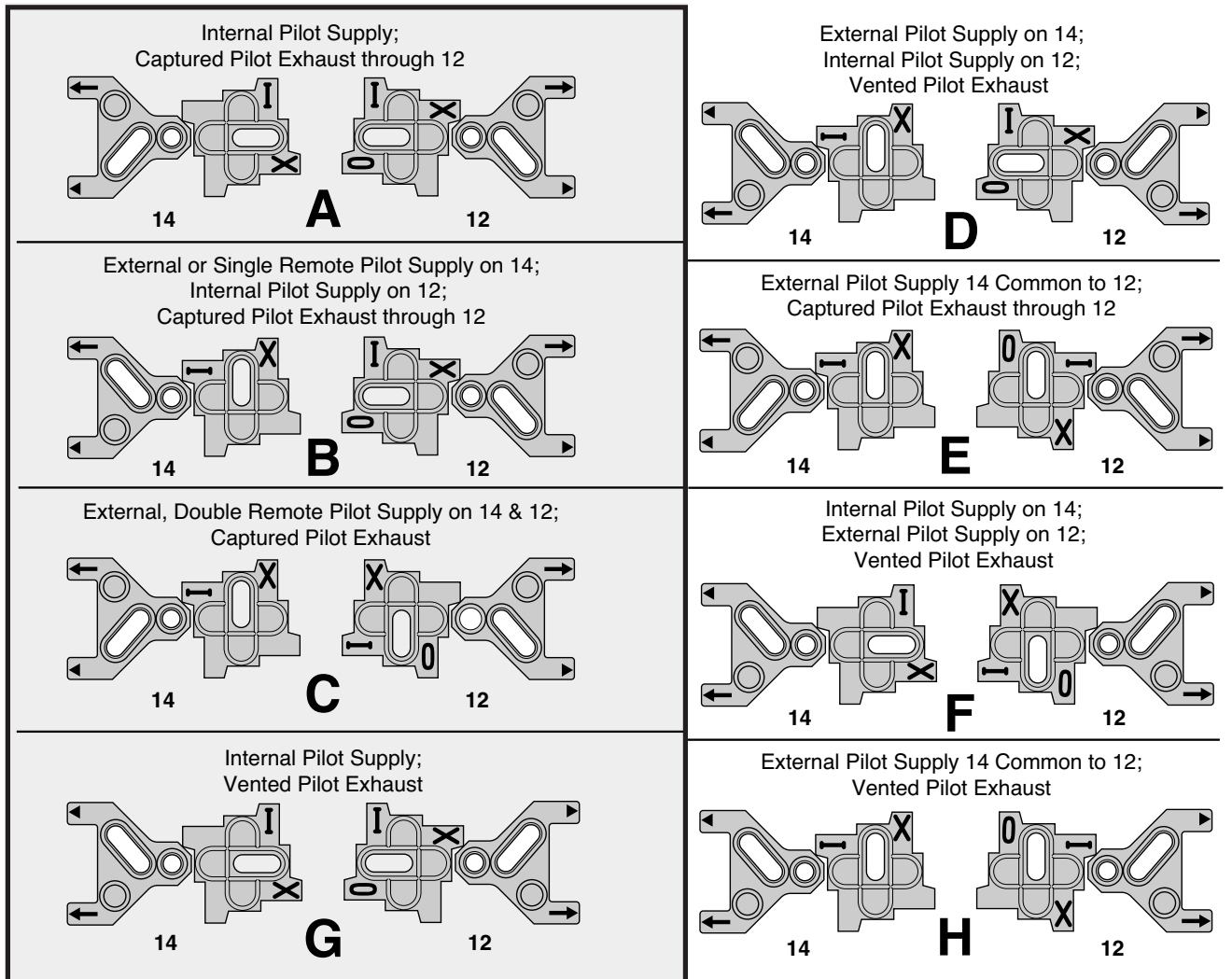

Base Pilot Port Used	None	14	14 and 12	None	14	14	12
Pilot Air Supply	Internal Pilot Supply	14 External Pilot 12 Internal Pilot	External, Double Remote Pilot for 14 and 12	Internal Pilot Supply	14 External Pilot 12 Internal Pilot	One Common External Pilot Pressure for 14 and 12	14 Internal Pilot 12 External Pilot
Pilot Exhaust	Captured	Captured	Captured	Vented	Vented	Captured	Vented
5/2 Double Solenoid	606 A	—	406 C	604 G	D	E	F
5/2 Single Solenoid	621	421	C	620	D	E	F
5/2 Double Solenoid, on Sandwich Regulator	—	—	—	—	External Pilot Supply 14 Common to 12 Vented Pilot Exhaust – See Diagram 'H'		
Spring Return	A	B	—	G	—	—	—
5/2 Single Solenoid, Differential Return	651 A	451 B	C	65 G	D	E	F
5/3 Pressure Center Exhaust	611 A	—	411 C	627 G	D	E	F
5/3 Pressure All Ports Blocked	616 A	—	416 C	625 G	D	E	F
Part Numbers Available From Factory					See Gasket Configurations Above for These Special Adaptations		

Insert a muffler or vent in the EXH Port of the PEJ02 & PEJ01 Manifold End Plates or #12 of PL02 & PL01 Subbases when using solenoids with a **Captured** Exhaust.

A plug may be inserted in the EXH Port of the PEJ02 & PEJ01 Manifold End Plates #14 or #12 of PL02 & PL01 Subbases when using a **Vented** Exhaust.

D
 Subbase & Manual Valves
 H Series Micro
 Modulflex Series
 H Series ISO
 Network Connectivity
 DX ISOMAX Series
 Valvair II Series



For inventory, lead times, and kit lookup, visit www.pdnplu.com

DX01 Manifold Assembly

Ports

- 1 Pressure
- 2 #2 Cylinder Port, 1 to 2 Flow Path
- 3 Cylinder Exhaust Port, 2 to 3 Flow Path
- 4 #4 Cylinder Port, 1 to 4 Flow Path
- 5 Cylinder Exhaust Port, 4 to 5 Flow Path
- 14 #14 Pilot Port
- 12 #12 Pilot Port

Torque Specifications: 25 to 35 in-lbs (2.82 to 3.95 Nm)

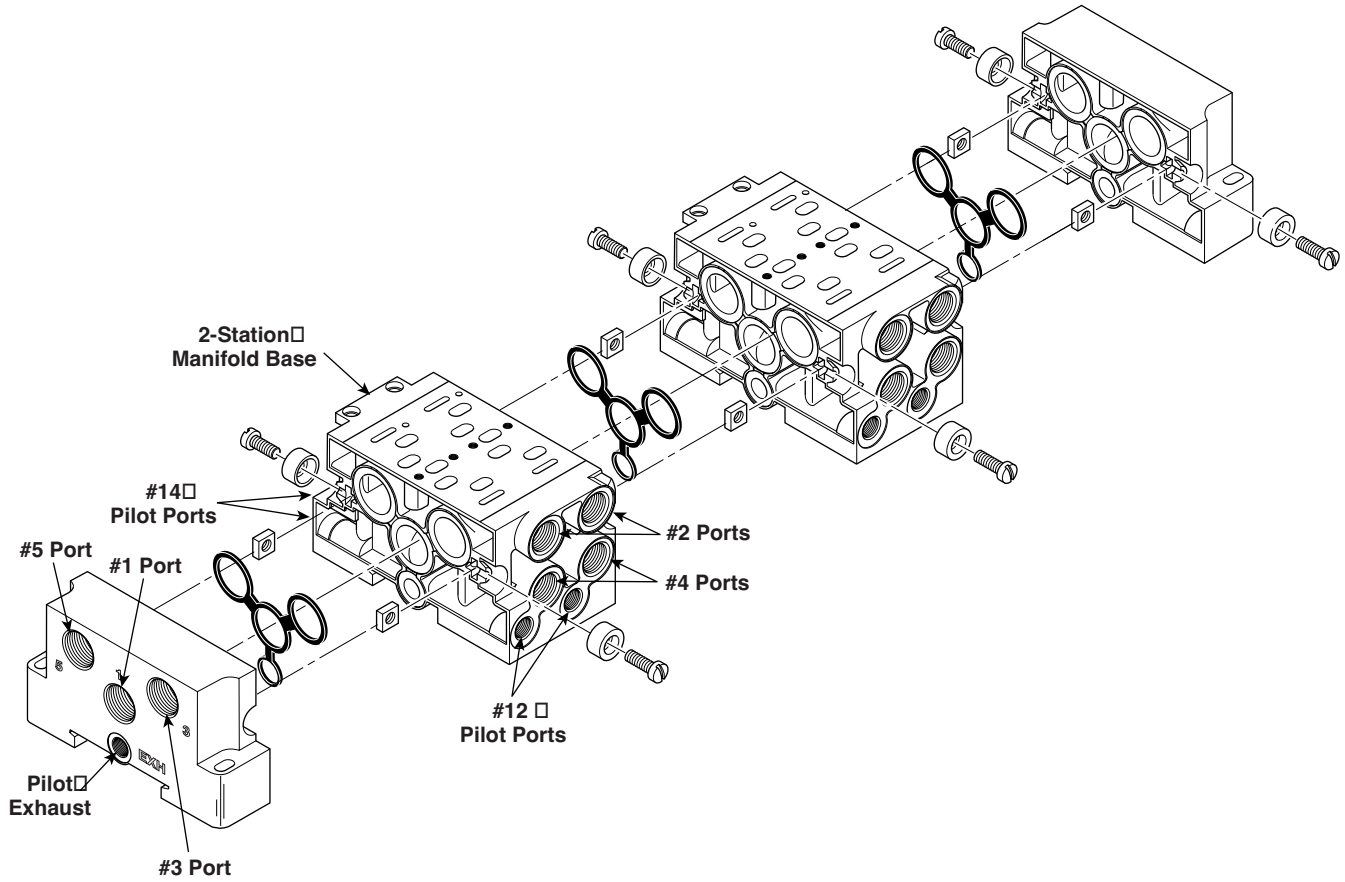

DX01 Shown

D
Subbase & Manual Valves
H Series Micro
Modulflex Series
H Series ISO
Network Connectivity
DX ISOMAX Series
Valvair II Series



For inventory, lead times, and kit lookup, visit www.pdnplu.com

D255

Parker Hannifin Corporation
 Pneumatic Division
 Richland, Michigan
www.parker.com/pneumatics

DX 15407-1 Size 01, Manifold Conversion Instructions

Captured Pilot Exhaust

PJL01, Size 01

A Built-in 2-Position Selector converts the External Pilot Channel (12) into a Common Solenoid Pilot Exhaust Channel.

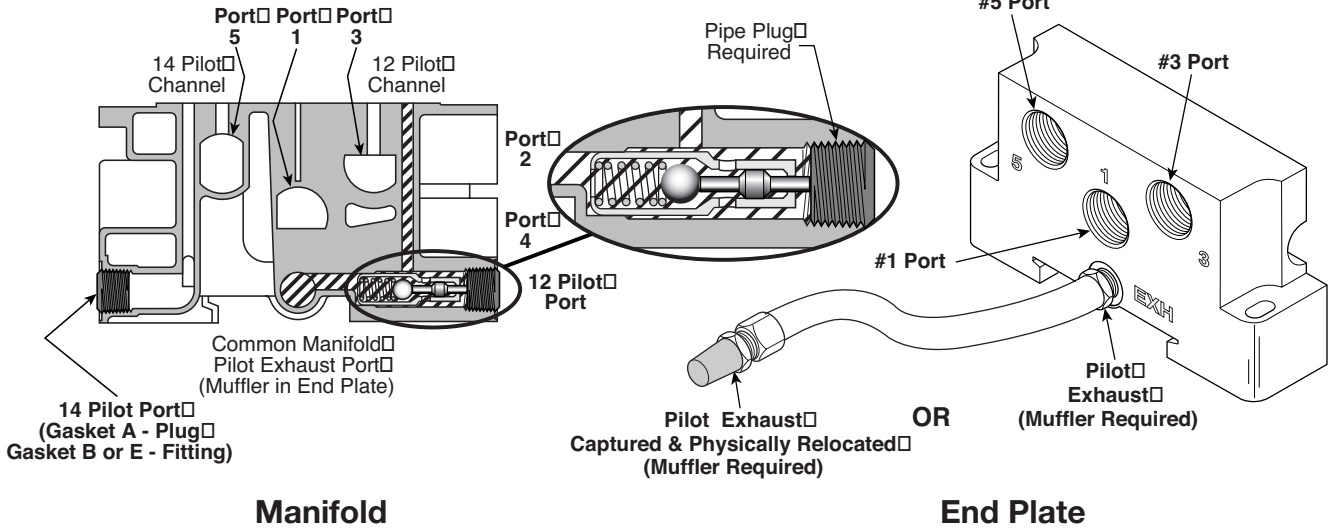

Built-in Selector

When using A, B or E **Captured** Selector Gasket Positions, the 12 Pilot Port is plugged. The 14 Pilot Port has a plug when using Gasket A or a fitting when using Gasket B or E. When in place, the Plug in the 12 Pilot Port depresses the Selector to connect the Valve Solenoid Pilot Exhaust to a Common Manifold Exhaust Port. The Plug must make contact with the Pin of the Internal Check Valve.

Insert a Muffler in the EXH Port of the End Plate.

Captured Selector Gasket Positions

When using A, B or E Selector Gasket Positions as shown in the schematic at right.

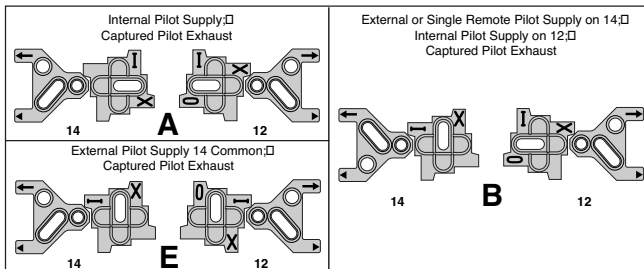

Insert a muffler or vent in the EXH Port of the PEJ02 & PEJ01 Manifold End Plates or #12 of PL02 & PL01 Subbases when using solenoids with **Captured** Pilot Exhaust.

DX01 Manifold Assembly Schematic for Captured Selector Gasket Positions A, B and E

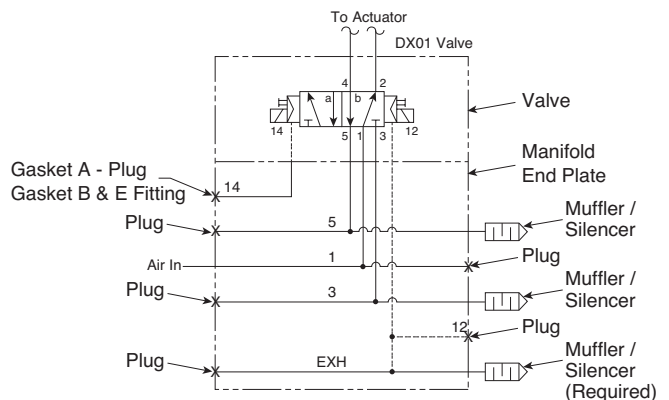

D

Subbase & Manual Valves

H Series Micro

Modulflex Series

H Series ISO

Network Connectivity

DX ISOMAX Series

Valvair-II Series



For inventory, lead times, and kit lookup, visit www.pdnplu.com

D256

Parker Hannifin Corporation
 Pneumatic Division
 Richland, Michigan
www.parker.com/pneumatics

DX 15407-1 Size 01, Manifold Conversion Instructions

**Vented
 Pilot Exhaust**

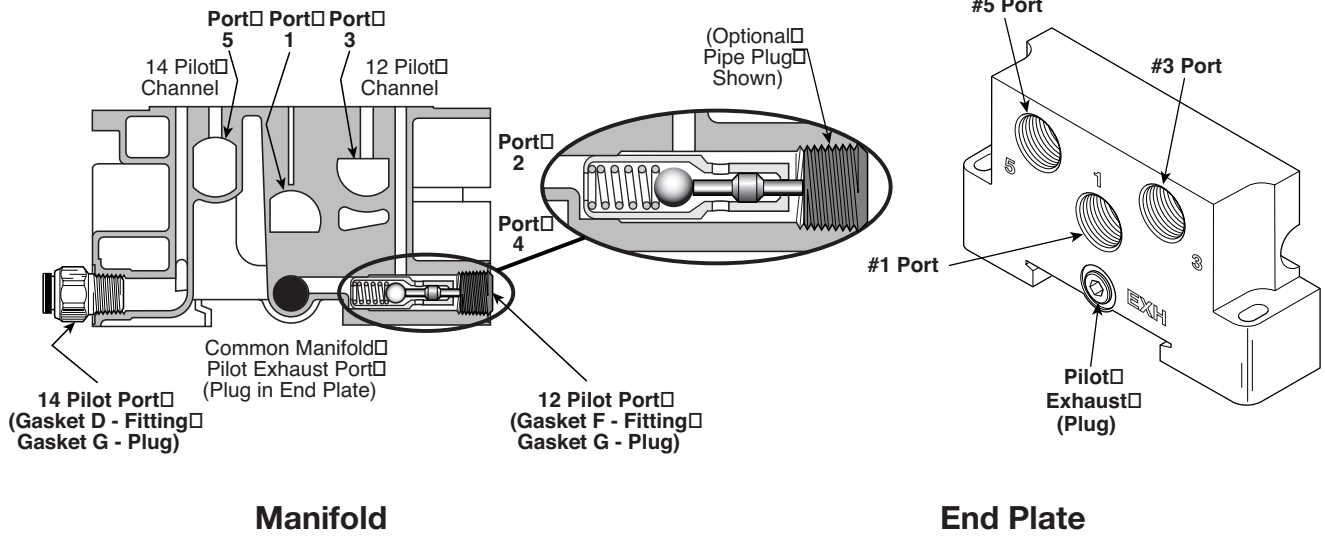

Built-in Selector

When using D or G **Vented** Selector Gasket Positions, the 12 Pilot Port may be plugged (Optional). The 14 Pilot Port has a plug when using Gasket G or a fitting when using Gasket D or F. The valve solenoid pilot exhaust vents out the pilot adapter on the G Gasket Selection.

Vented Selector Gasket Positions

When using D, F or G Selector Gasket Positions, pilot exhaust air is vented out the valve.

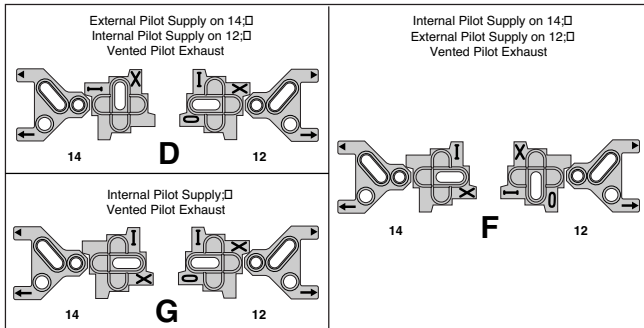

A plug may be inserted in the EXH Port of the PEJ02 & PEJ01 Manifold End Plates, #12 of PL02 & PL01 Subbases.

**DX01 Manifold Assembly
 Schematic for Vented Selector Gasket Positions D or G**

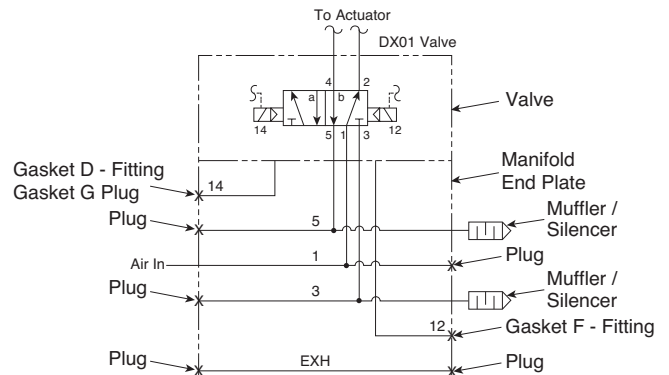

DX 15407-1 Size 01, Manifold Conversion Instructions

External Double Remote Pilot

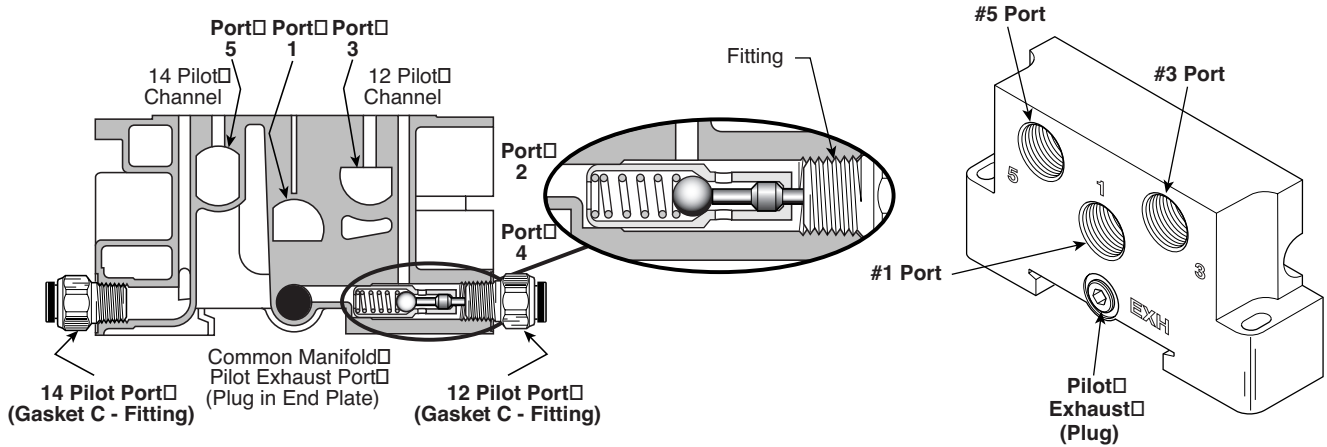

Built-in Selector

When using C **External Double Remote Pilot** Selector Gasket Position, a fitting is used in Pilot Port 14 & 12. Free flow between Port 14 & 12 and the valve allows Remote Pilot Pressure and an exhaust path for the captured pilot exhaust.

External Double Remote Pilot Selector Gasket Position

When using C Selector Gasket Position.

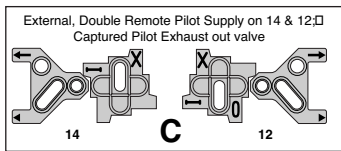

DX01 Manifold Assembly Schematic for External Double Remote Pilot Selector Gasket Position C

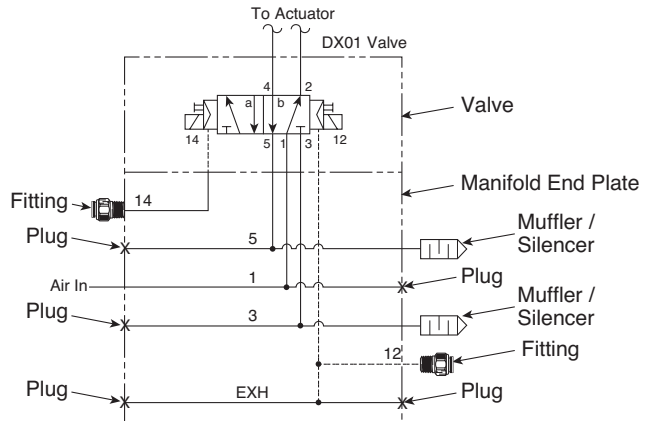

D

Subbase & Manual Valves

H Series Micro

Modulflex Series

H Series ISO

Network Connectivity

DX ISOMAX Series

Valvair II Series



For inventory, lead times, and kit lookup, visit www.pdnplu.com

D258

Parker Hannifin Corporation
 Pneumatic Division
 Richland, Michigan
www.parker.com/pneumatics

DX02 Manifold Assembly

Ports

- 1.....Pressure
- 2.....#2 Cylinder Port, 1 to 2 Flow Path
- 3.....Cylinder Exhaust Port, 2 to 3 Flow Path
- 4.....#4 Cylinder Port, 1 to 4 Flow Path
- 5.....Cylinder Exhaust Port, 4 to 5 Flow Path
- 14.....#14 Pilot Port
- 12.....#12 Pilot Port

Torque Specifications: 25 to 35 in-lbs (2.82 to 3.95 Nm)

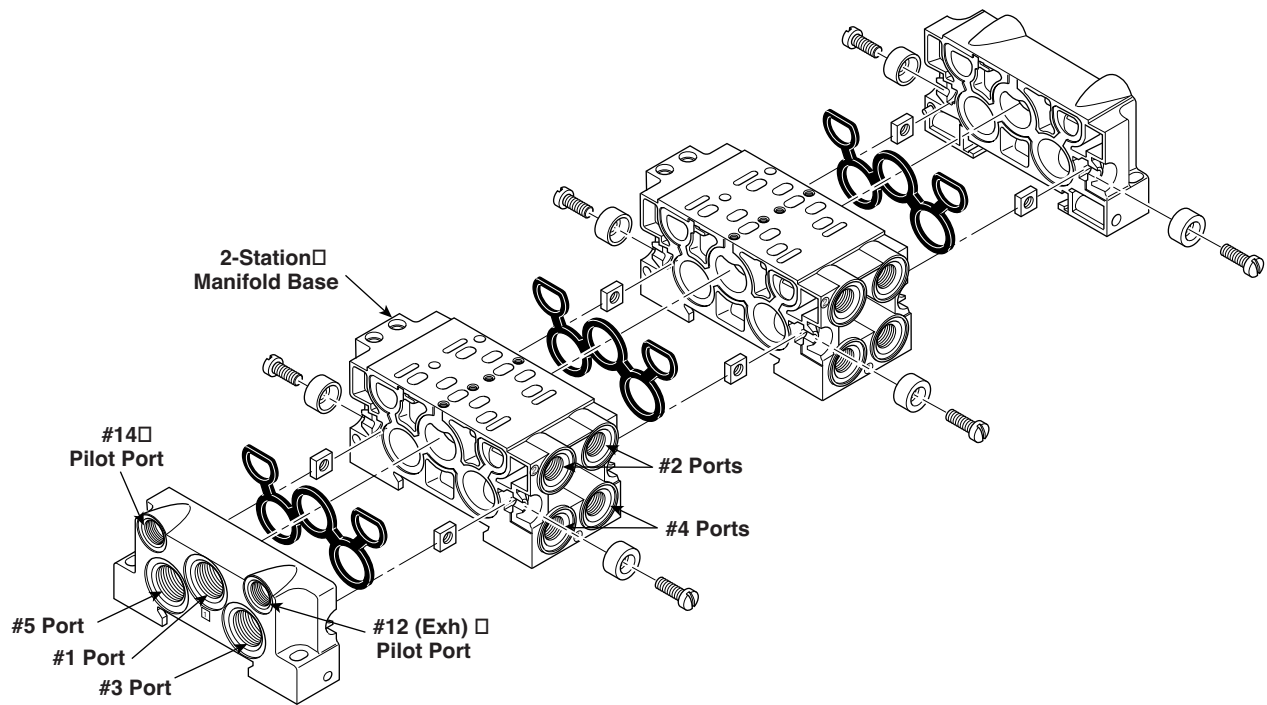

DX02 Shown



For inventory, lead times, and kit lookup, visit www.pdnplu.com

D259

Parker Hannifin Corporation
 Pneumatic Division
 Richland, Michigan
www.parker.com/pneumatics

D

Subbase & Manual Valves

H Series Micro

Moduflex Series

H Series ISO

Network Connectivity

DX ISOMAX Series

Valvair II Series

DX 15407-1 Size 02, Manifold Conversion Instructions

***Captured
 Pilot Exhaust***

PJLP02, Size 02*

As shown in the illustrations below, the EXH (12) & 14 Pilot Ports are exhausted internally in the valve body into a single chamber labeled EXH on the end plate. When using A, B, D or E Selector Gasket Positions, the EXH (12) Pilot Port is vented with a muffler or micron screen. The 14 Pilot Port is plugged.

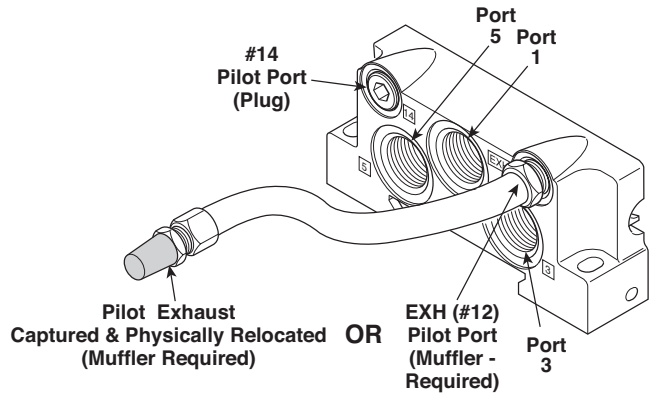
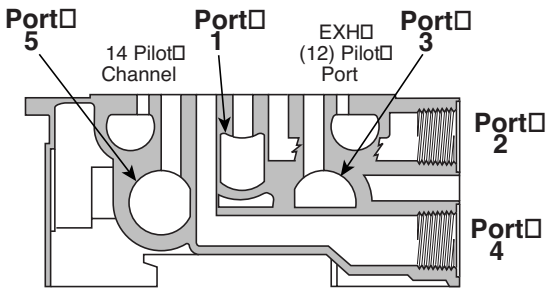

D
 Subbase & Manual Valves
 H Series Micro
 Modulflex Series
 H Series ISO
 Network Connectivity
 DX ISOMAX Series
 Valvair II Series

Captured Selector Gasket Positions

When using A, B, D or E, Selector Gasket Positions, the ports must be either plugged or vented with a muffler or micron screen as shown in the schematic at right.

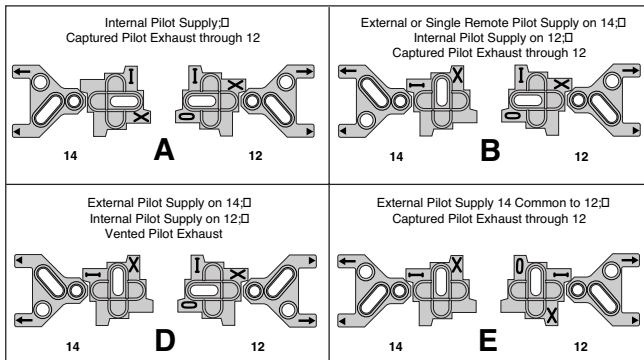

* PJLP02 Manifolds can be used for External Pilot, **NOT** Remote Pilot

DX02 Manifold Assembly Schematic for Captured Selector Gasket Positions A, B, D and E

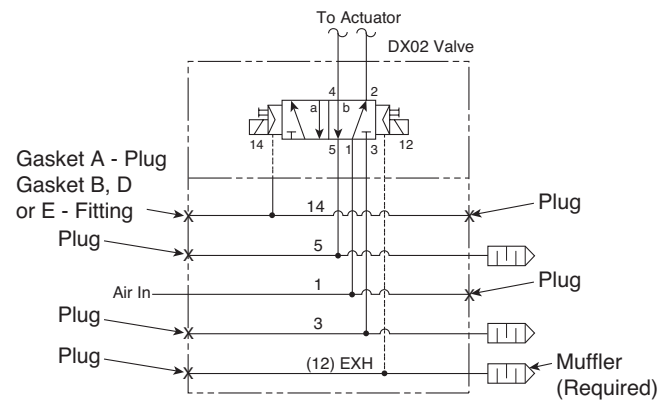

For inventory, lead times, and kit lookup, visit www.pdnplu.com

D260

Parker Hannifin Corporation
 Pneumatic Division
 Richland, Michigan
www.parker.com/pneumatics

DX 15407-1 Size 02, Manifold Conversion Instructions

**Vented
 Pilot Exhaust**

PJLP02, Size 02

When using F or G Selector Gasket Positions, the EXH (12) Pilot Port and the 14 Pilot Port are plugged and the Pilot Exhaust is vented through the Pilot Adapter.

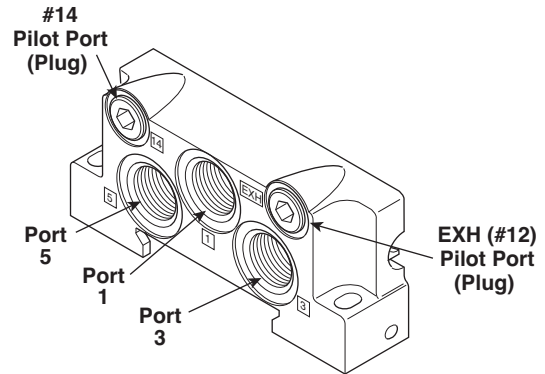
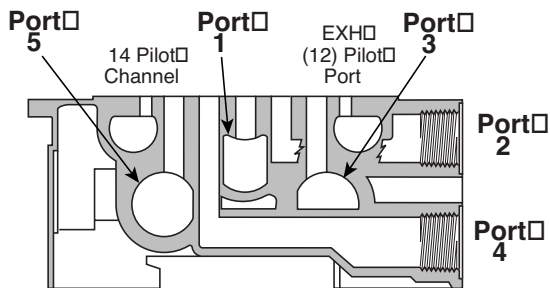

Vented Selector Gasket Positions

When using F or G, Selector Gasket Positions, the ports must be either plugged or vented with a muffler or micron screen as shown in the schematic at right.

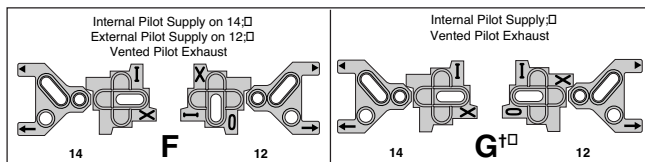

† A plug may be inserted in the EXH Port of the PEJ02 & PEJ01 Manifold End Plates or #12 of PL02 & PL01 Subbases.

**DX02 Manifold Assembly
 Schematic for Vented Selector Gasket
 Positions F and G**

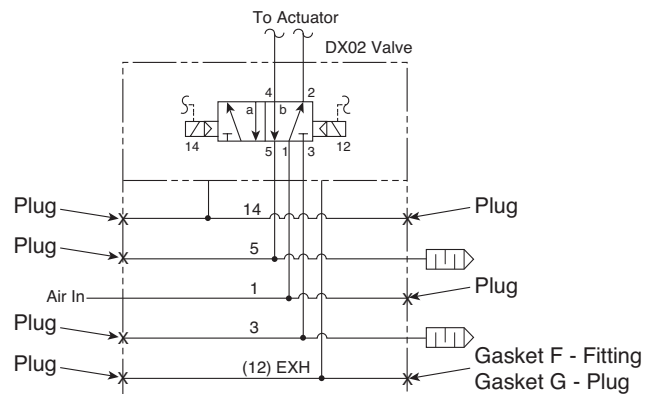

Subbase Assembly

Ports

- 1..... Pressure
- 2..... #2 Cylinder Port. 1 to 2 Flow Path.
- 3..... Cylinder Exhaust Port. 2 to 3 Flow Path.
- 4..... #4 Cylinder Port. 1 to 4 Flow Path.
- 5..... #4 Cylinder Port. 1 to 5 Flow Path.
- 14..... #14 Pilot Port
- 12..... #12 Pilot Port

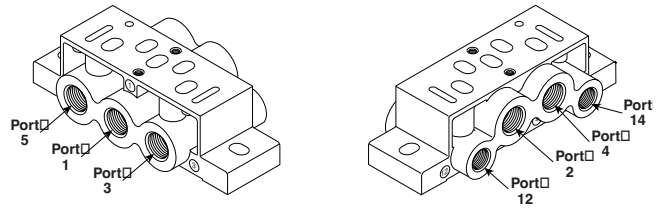

Captured Selector Gasket Positions

When using A, B, C, D or E, Selector Gasket Positions, the ports must be either plugged or vented with a muffler or micron screen as shown in the schematic at right.

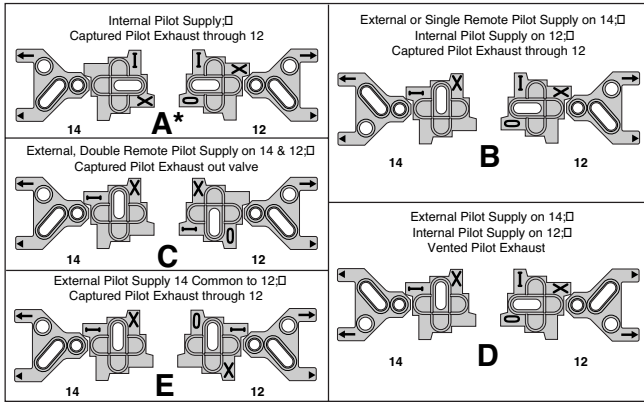

DX02 & DX01 Subbase Assembly Schematic for Captured Selector Gasket Positions A, B, C, D and E

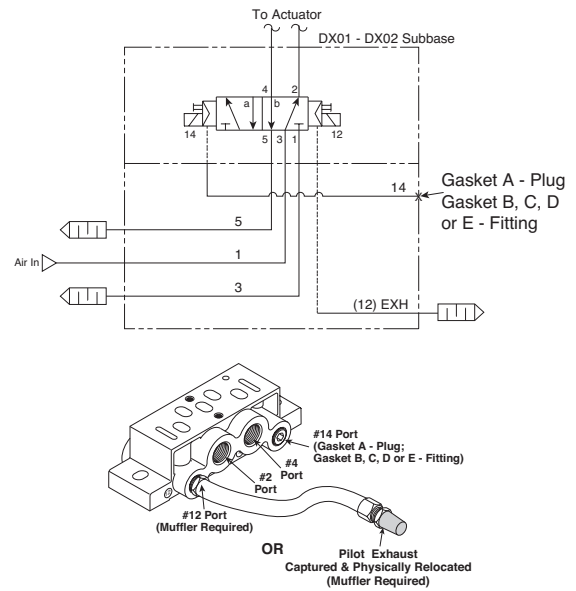

Vented Selector Gasket Positions

When using F or G, Selector Gasket Positions, the ports must be either plugged or vented with a muffler or micron screen as shown in the schematic at right.

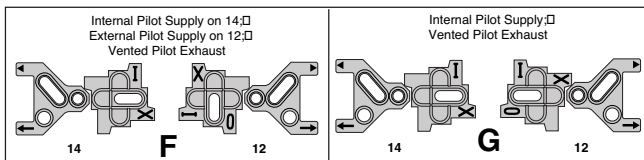

DX02 & DX01 Subbase Assembly Schematic for Vented Selector Gasket Positions F and G

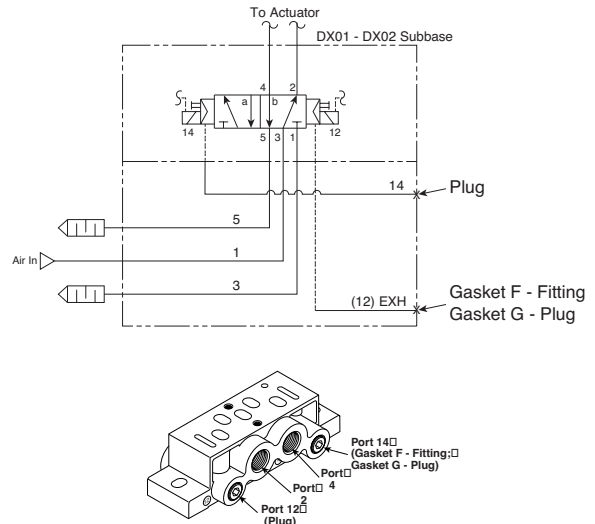

D
 Subbase & Manual Valves
 H Series Micro
 Modulflex Series
 H Series ISO
 Network Connectivity
 DX ISOMAX Series
 Valvair II Series



For inventory, lead times, and kit lookup, visit www.pdnplu.com

DX1 / DX2 / DX3

Internal / External Pilot Conversion Instructions

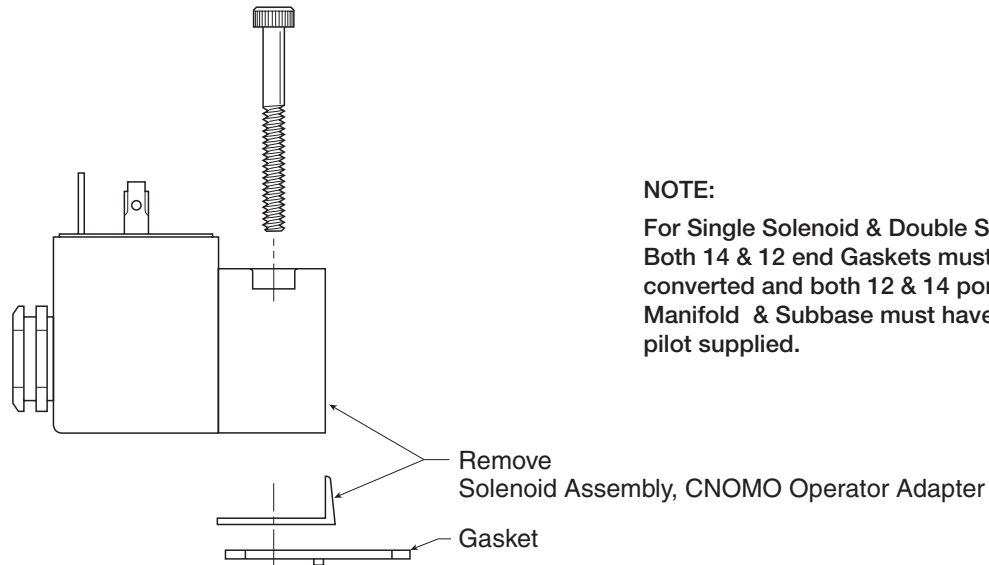

NOTE:

For Single Solenoid & Double Solenoid – Both 14 & 12 end Gaskets must be converted and both 12 & 14 ports in the Manifold & Subbase must have external pilot supplied.

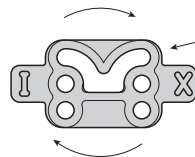
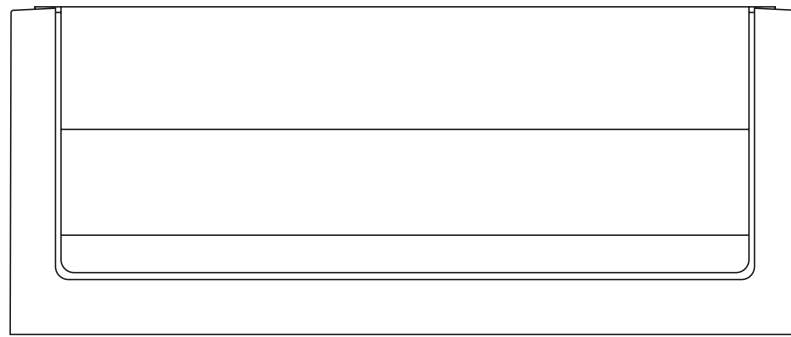

Remove Gasket and Rotate to Show "I" in Position as Shown and Reinstall Gasket and Covers. (Valve is Now External Pilot)

Position of Gasket for Internal Pilot when Using with Solenoid Operator

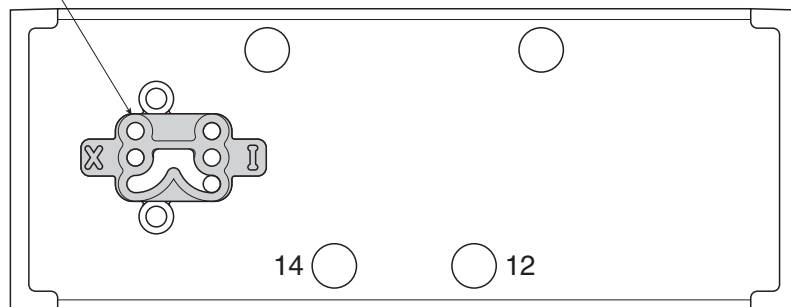

D

Subbase & Manual Valves

H Series Micro

Modulflex Series

H Series ISO

Network Connectivity

DX ISOMAX Series

Valvair II Series

DX1, DX2, DX3 VDMA & 5599-1 Side Ported Subbase

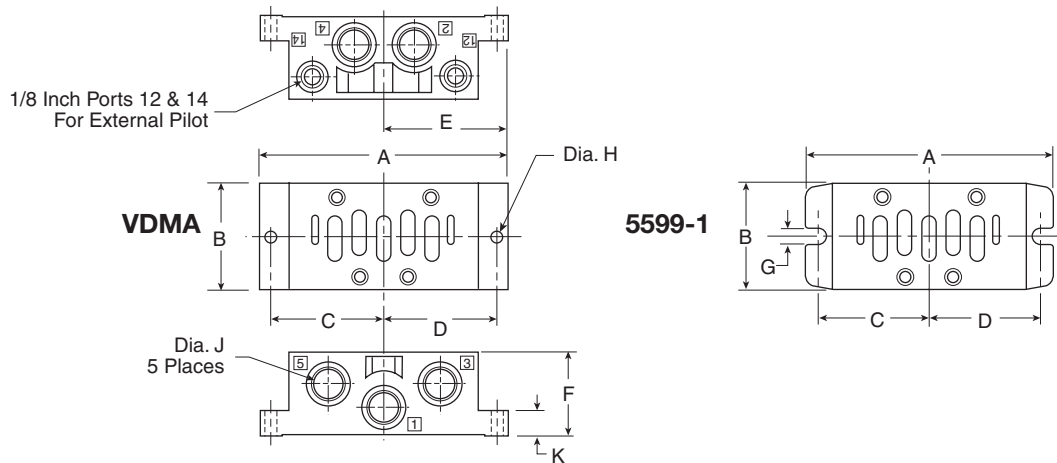

Series	Part Number	J	A	B	C	D	E	F	G	H	K	
VDMA	DX1	P2N-VS512SD	BSPP G1/4	4.33 (110)	1.89 (48)	1.93 (49)	1.93 (49)	2.17 (55)	1.26 (32)	—	0.22 (5.5)	0.39 (9.9)
	DX2	P2N-WS513SD	BSPP G3/8	4.88 (124)	2.21 (56)	2.21 (56)	2.21 (56)	2.44 (62)	1.57 (40)	—	0.26 (6.6)	0.51 (13)
	DX3	P2N-YS514SD	BSPP G1/2	5.87 (149)	2.80 (71)	2.68 (68)	2.68 (68)	2.93 (74.5)	2.05 (52)	—	0.26 (6.6)	0.71 (18)
5599-1	DX1	PL1-1/4-70	BSPP G1/4	4.33 (110)	1.81 (46)	1.93 (49)	1.93 (49)	2.17 (55)	1.14 (29)	0.22 (5.5)	—	0.24 (6)
		PL1-1/4-80	NPT 1/4									
	DX2	PL2-3/8-70	BSPP G3/8	4.88 (124)	2.21 (56)	2.17 (55)	2.17 (55)	2.44 (62)	1.46 (37)	0.22 (5.5)	—	0.24 (6)
		PL2-3/8-80	NPT 3/8									
	DX3	PL3-1/2-70	BSPP G1/2	5.87 (149)	2.80 (71)	2.68 (68)	2.68 (68)	2.93 (74.5)	2.36 (60)	0.26 (6.6)	—	0.71 (18)
		PL3-1/2-80	NPT 1/2									

Inches (mm)

DX1, DX2 5599-1 Bottom Ported Subbase

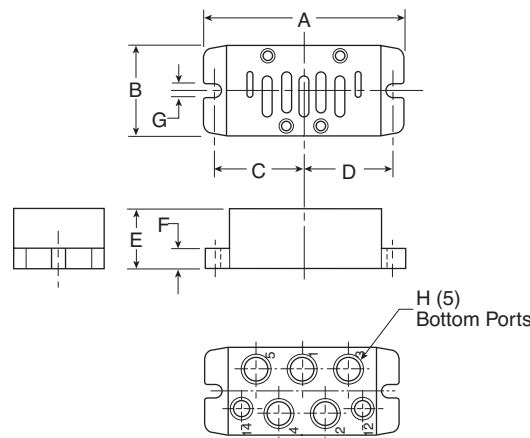

Bottom Ported Subbase

Series	Part Number	H	A	B	C	D	E	F	G
DX1	PD1-1/4-70	BSPP G1/4	4.33 (110)	1.81 (46)	1.93 (49)	1.93 (49)	1.14 (29)	0.24 (6)	0.22 (5.5)
	PD1-1/4-80	NPT 1/4							
DX2	PD2-3/8-70	BSPP G13/8	4.88 (124)	2.20 (56)	2.17 (55)	2.17 (55)	1.46 (37)	0.24 (6)	0.22 (5.5)
	PD2-3/8-80	NPT 3/8							

Inches (mm)

D
 Subbase & Manual Valves
 H Series Micro
 Modulflex Series
 H Series ISO
 Network Connectivity
 DX ISOMAX Series
 Valvair II Series



For inventory, lead times, and kit lookup, visit www.pdnplu.com

D264

Parker Hannifin Corporation
 Pneumatic Division
 Richland, Michigan
www.parker.com/pneumatics

DX01 & DX02 Valve

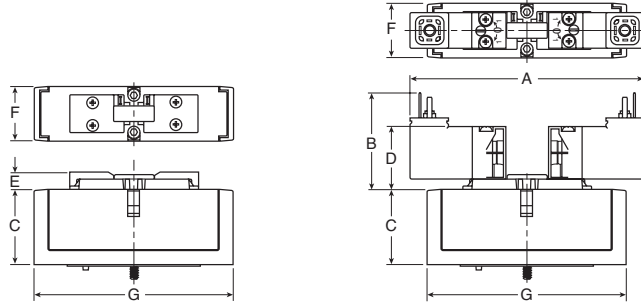

Series	A	B	C	D	E	F	G
DX02	4.06 (103)	1.61 (41)	1.41 (36)	1.06 (27)	.31 (8)	.71 (18)	3.15 (80)
DX01	4.06 (103)	1.61 (41)	1.41 (36)	1.06 (27)	.31 (8)	1.02 (26)	3.94 (100)

Inches (mm)

DX01 & DX02 Individual Subbase

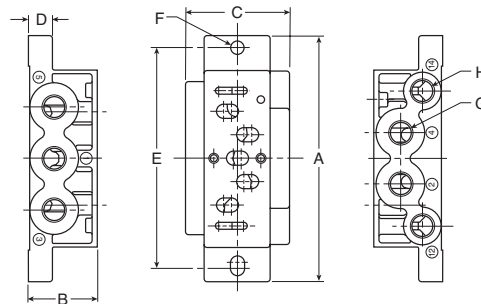

Series	Part Number	A	B	C	D	E	F	G	H
DX02	PL02	3.15 (80)	.87 (22)	1.06 (27)	.31 (8)	2.76 (70)	.216 Dia. (Ø 5.5)	1/8	M5
DX01	PL01	3.94 (100)	1.10 (28)	1.65 (42)	.39 (10)	3.54 (90)	.216 Dia. (Ø 5.5)	1/4	1/8

Inches (mm)

DX01 & DX02 2-Station Manifold Base

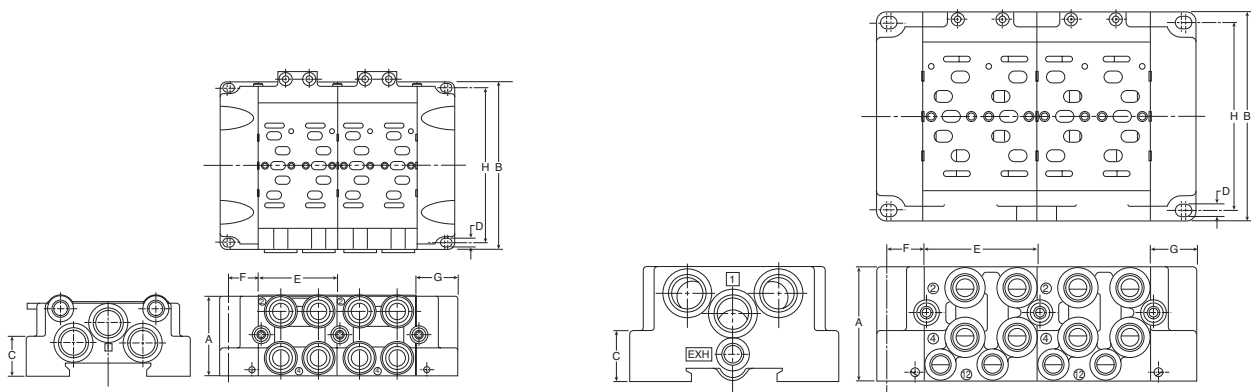

Series	Part Number	A	B	C	D	E	F	G	H
DX02	PJLP02 / PEJ02	1.52 (38.5)	3.15 (80)	.47 (12)	.165 Dia. (Ø 4.2)	1.50 (38)	.55 (14)	.71 (18)	2.83 (72)
DX01	PJL01 / PJLP01 / PEJ01	2.17 (55)	3.94 (100)	.94 (24)	.216 Dia. (Ø 5.5)	2.13 (54)	.67 (17)	.87 (22)	3.54 (90)

Inches (mm)



For inventory, lead times, and kit lookup, visit www.pdnplu.com

D265

Parker Hannifin Corporation
 Pneumatic Division
 Richland, Michigan
www.parker.com/pneumatics

D

Subbase & Manual Valves

H Series Micro

Modulflex Series

H Series ISO

Network Connectivity

DX ISOMAX Series

Valvair II Series

DX01 15407-1, PS5511 Subbases

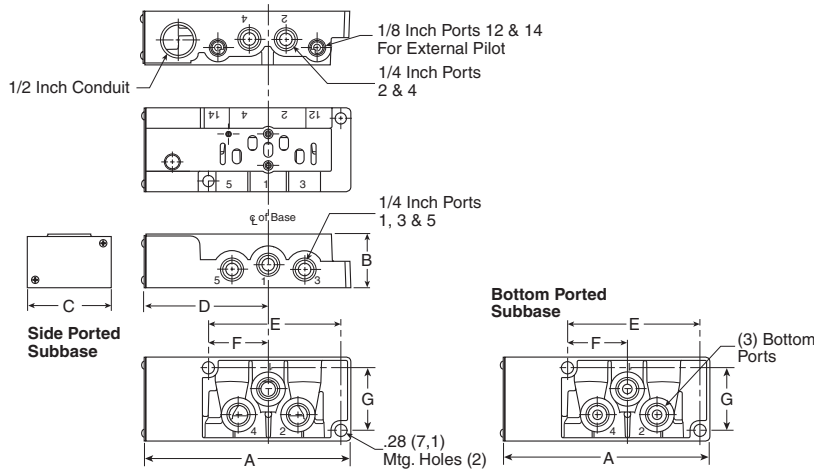

PS5511 Subbase

A	B	C	D
4.88 (124)	1.28 (32.5)	2.00 (50.8)	2.91 (74)
E	F	G	
1.43 (36.2)	3.16 (80.2)	1.49 (37.9)	

Inches (mm)

DX02 & DX01 15407-1, PS5611 & PS5511 Manifolds

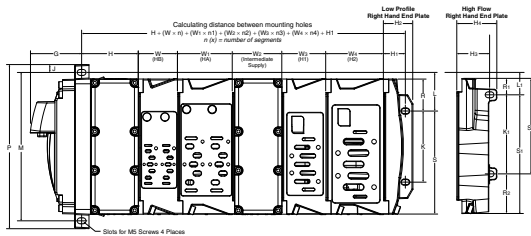

A	B	C1	C2	C3	C4	C5
6.81 (172.95)	6.16 (156.5)	1.65 (41.79)	2.28 (57.79)	2.04 (51.79)	1.84 (46.79)	2.39 (60.79)
D1	D2	D3	D4	E	F	G
1.60 (40.71)	1.60 (40.71)	0.96 (24.3)	1.92 (48.8)	0.32 (8.0)	3.09 (78.58)	4.39 (111.58)
J1	J2	J3	K	L	M	N
0.44 (11.2)	1.92 (48.7)	1.31 (33.3)	0.30 (7.5)	4.14 (105.08)	2.40 (61.08)	1.92 (48.7)
O	P	Q	R			
4.21 (107)	4.45 (113)	6.09 (154.77)	6.51 (165.32)			

Inches (mm)

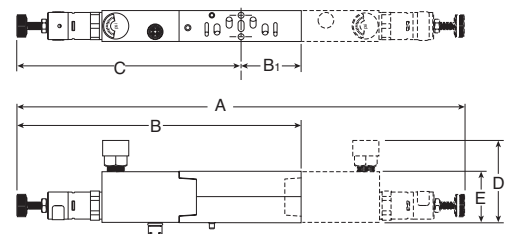
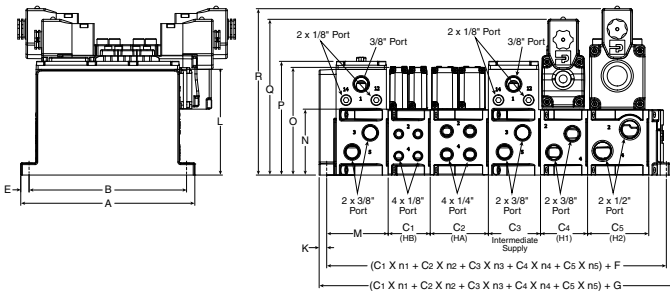

Series	Part Number	A	B	B1	C	D	E
DX02	PS5637	10.28 (261)	6.14 (156)	1.02 (26)	5.13 (130)	2.60 (66)	1.18 (30)
DX01	PS5537	10.00 (254)	6.42 (163)	1.42 (36)	5.00 (127)	2.72 (69)	1.18 (30)

Inches (mm)

D
 Subbase & Manual Valves
 H Series Micro
 Modulflex Series
 H Series ISO
 Network Connectivity
 DX ISOMAX Series
 Valvair II Series



For inventory, lead times, and kit lookup, visit www.pdnplu.com

D266

Parker Hannifin Corporation
 Pneumatic Division
 Richland, Michigan
www.parker.com/pneumatics

DX1, DX2 & DX3 Air Operated Valve

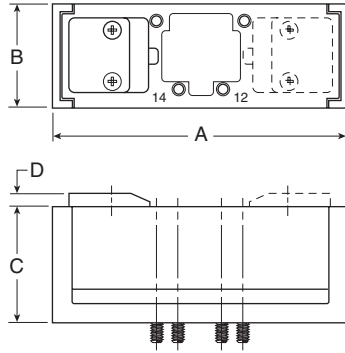

Series	A	B	C	D
DX1	4.72 (120)	1.65 (42)	1.85 (47)	.20 (5)
DX2	5.51 (140)	2.13 (54)	2.30 (58.5)	.20 (5)
DX3	6.69 (170)	2.68 (68)	2.80 (71)	.20 (5)

Inches (mm)

DX1, DX2 & DX3 Solenoid Operated Valve

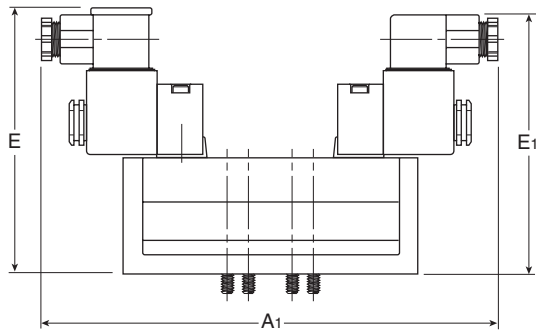

Series	A1	E	E1	E2
DX1	7.97 (202.5)	4.43 (112.5)	4.69 (119)	4.53 (115)
DX2	8.58 (218)	4.86 (123.5)	5.12 (130)	4.98 (126.5)
DX3	9.27 (235.5)	5.35 (136)	5.61 (142.5)	5.47 (139)

Inches (mm)

D

Subbase & Manual
Valves

H Series
Micro

Moduflex
Series

H Series
ISO

Network
Connectivity

**DX ISOMAX
Series**

Valvair II
Series

DX3 Subbase

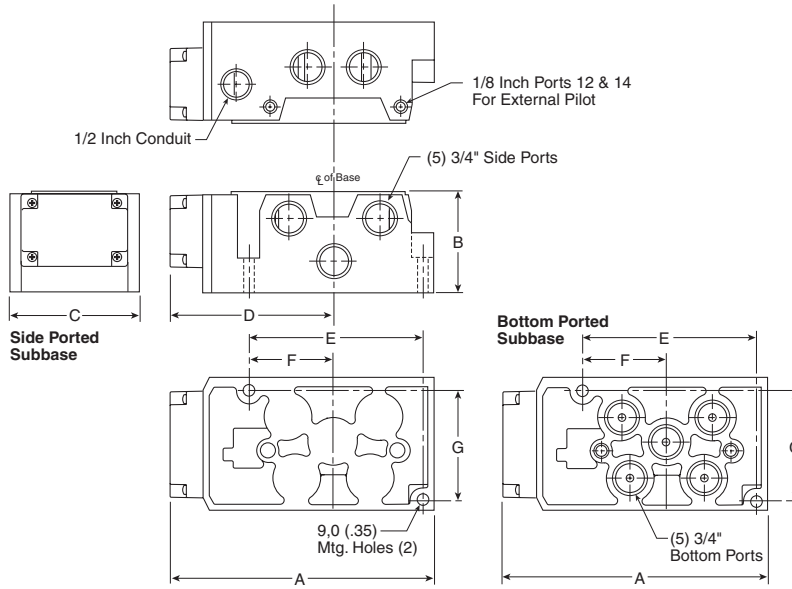

PS4211 Subbase

A	B	C	D
7.90 (201)	2.96 (75)	3.90 (990)	4.92 (125)
E	F	G	
5.14 (131)	2.50 (64)	3.24 (82)	

Inches (mm)

D

Subbase & Manual
 Valves

H Series
 Micro

Modulflex
 Series

H Series
 ISO

Network
 Connectivity

DX ISOMAX
 Series

Valvair II
 Series



For inventory, lead times, and kit lookup, visit www.pdnplu.com

D268

Parker Hannifin Corporation
 Pneumatic Division
 Richland, Michigan
www.parker.com/pneumatics

DX1 Manifold

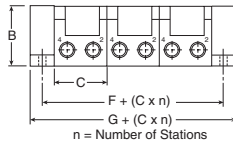
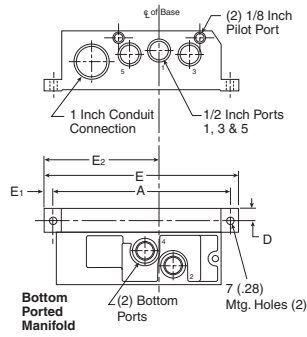

PS4011 Manifold

A	B	C	D	E
6.50 (165)	2.20 (56)	1.93 (49)	.44 (11)	7.15 (182)
E1	E2	F	G	
.33 (8)	4.25 (108)	.87 (22)	1.80 (46)	

Inches (mm)

DX2 Manifold

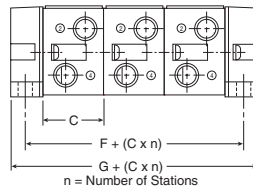
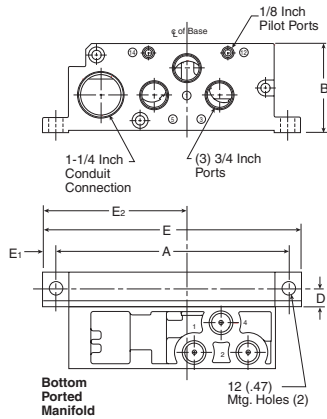

PS4111 Manifold

A	B	C	D	E
8.46 (215)	3.35 (85)	2.20 (56)	.59 (15)	9.41 (239)
E1	E2	F	G	
.47 (12)	5.28 (134)	1.18 (30)	2.36 (60)	

Inches (mm)

DX3 Manifold

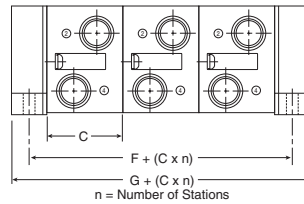
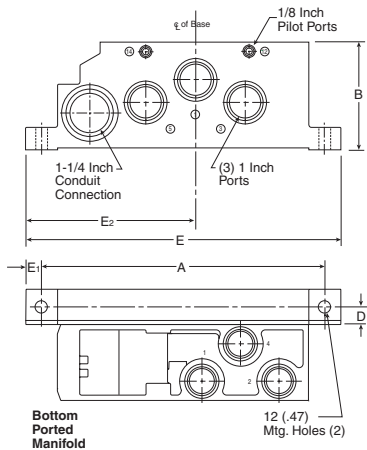

PS4211 Manifold

A	B	C	D	E
10.41 (265)	4.13 (105)	2.80 (71)	.65 (175)	11.61 (295)
E1	E2	F	G	
.59 (15)	6.26 (159)	1.30 (33)	2.60 (63)	

Inches (mm)



For inventory, lead times, and kit lookup, visit www.pdnplu.com

D269

Parker Hannifin Corporation
 Pneumatic Division
 Richland, Michigan
www.parker.com/pneumatics

D

Subbase & Manual Valves

H Series Micro

Moduflex Series

H Series ISO

Network Connectivity

DX ISOMAX Series

Valvair II Series

DX1, DX2, DX3 5599-1 VDMA

Form C Manifold &
 Form D End Plates

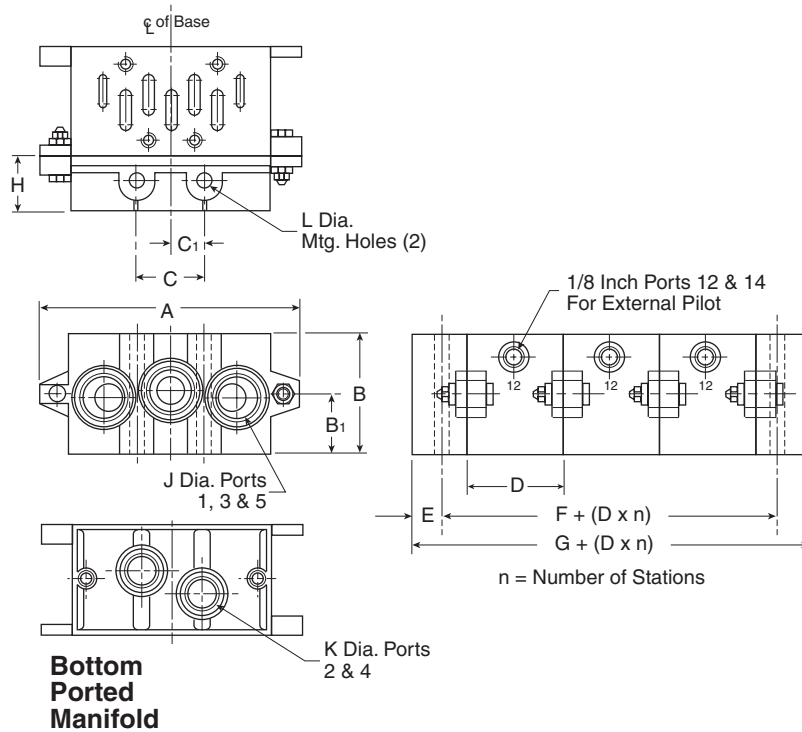

Bottom Ported Manifold

VDMA Form C Manifold

Series	Part Number	A	B	B1	D	E	F	G	J	K
DX1	P2N-VM512MB	4.33 (110)	1.81 (46)	0.94 (24)	1.69 (55)	0.43 (22)	0.87 (22)	1.73 (44)	BSPP G3/8	BSPP G1/4
DX2	P2N-WM513MB	5.31 (135)	1.85 (47)	0.94 (24)	2.20 (56)	0.51 (13)	1.02 (26)	2.05 (52)	BSPP G1/2	BSPP G3/8
DX3	P2N-YM514MB	7.48 (190)	2.20 (56)	1.34 (34)	2.80 (71)	0.59 (15)	1.18 (30)	2.36 (60)	BSPP G1/2	BSPP G1/2

VDMA Form D End Plate

Series	Part Number	A	B	B1	C	C1	H	L
DX1	P2N-VM513ES	4.33 (110)	1.81 (46)	0.94 (24)	1.10 (28)	0.55 (14)	0.87 (22)	0.28 (7)
DX2	P2N-WM514ES	5.31 (135)	1.85 (47)	0.94 (24)	1.38 (35)	0.69 (18)	1.02 (26)	0.34 (9)
DX3	P2N-YM518ES	7.48 (190)	2.20 (56)	1.34 (34)	2.05 (52)	1.03 (26)	1.18 (30)	0.47 (12)

Inches (mm)

D
 Subbase & Manual Valves
 H Series Micro
 Moduflex Series
 H Series ISO
 Network Connectivity
 DX ISOMAX Series
 Valvair II Series



For inventory, lead times, and kit lookup, visit www.pdnplu.com

D270

Parker Hannifin Corporation
 Pneumatic Division
 Richland, Michigan
www.parker.com/pneumatics

Valvair II Series

- Full air operation for fastest response
- “Plug-in” option simplifies maintenance and installation
Reduces downtime. No wiring or plumbing to disturb
- “Direct pipe” design for economy and performance
- Variety of operators available; direct conduit, (JIC) junction box, NEMA 4, hazardous duty, (UL, CSA), and remote air pilot
- Field convertible to external pilot supply for vacuum or other services
- Synthetic rubber o-ring seals are specially compounded for minimum compression and friction for superior wear and abrasion resistance
- Precision ground spool “floats” on o-ring seals. Closed center cross-over design saves air
- General Purpose Approvals
 - CSA - Canadian Standards Association
File number 42024
- Hazardous Duty Approvals
 - UL - Underwriters Laboratories, Inc.
File number E42542 Category Y107
 - CSA - Canadian Standards Association
File number 24349

Material specifications

Manifolds & subbases	Aluminum alloy	
Other seals	Nitrile	
Resilient seals: in valve body		
Dynamic	Polyurethane base on 3/8" basic valves*	
Static / dynamic	Nitrile base w / 12% Molybdenum Disulphide on 1/4" & 1/2" basic valves	
Shock pads	Polyurethane	
Solenoid bodies	Plated zinc alloy	
Internal components	Corrosion resistant steel	
Resilient seals	Standard service	Nitrile
	Special service (continuous duty)	Fluorocarbon & Silicone
Other seals	Nitrile	
Coil	Class “B” epoxy encapsulated (Class “H” also available on some models, consult supplier)	
Valve bodies	Aluminum alloy	
Valve spacers	Brass	
Valve spool	Aluminum alloy with special coating on 3/8" basic valves*. Hard chrome plated AISI type 416 stainless steel on 1/4" & 1/2" basic valves.	

* These materials are specially designed for valves used on non-lubricated service

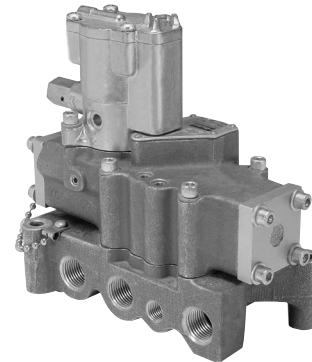

Operating information

Pressure range for solenoid operated valves

Media	Internal pilot supply			External pilot supply			
	1/4"	3/8"	1/2"	1/4"	3/8"	1/2"	1"
Air	35-140* PSIG			N.A. Main	0-250 PSIG Pilot		
Vacuum	do not use			N.A. Main	within 1 Hg of perfect Pilot		
Other	Consult supplier						

* 200 PSIG solenoid is optional (consult supplier).

Pressure range for remote pilot operated valves

Media		Valve type	
		Single	Double & 3-position
Air	Main	35-250 PSIG	0-250 PSIG
	Pilot	35-200 PSIG	35-200 PSIG
Vacuum	Main	Do not use	Within 1" Hg of perfect
	Pilot	Do not use	35-200 PSIG
Other	Consult supplier		

Ambient temperature – standard service solenoid operator

Minimum	Maximum	
	Intermittent duty	Continuous duty
0°F	125°F	100°F
Special service (continuous duty) solenoid operator		
0°F	125°F	125°F

Ambient temperature – remote pilot operated valves

0°F	200°F
-----	-------

As the above chart indicates, Standard Duty Solenoids may be used on continuous duty but ambient temperature is de-rated.
In some cases, Special Service Solenoids may be rated for higher ambient temperatures (consult supplier).



CAUTION:

If it is possible that the ambient temperature may fall below freezing, the medium must be moisture free to prevent internal damage and unpredictable behavior.

 Most popular.



For inventory, lead times, and kit lookup, visit www.pdnplu.com

D271

Parker Hannifin Corporation
Pneumatic Division
Richland, Michigan
www.parker.com/pneumatics

D

Subbase & Manual Valves

H Series Micro

Modulflex Series

H Series ISO

Network Connectivity

DX ISOMAX Series

Valvair II Series

3/8" Basic plug-in solenoid valve only with light

Symbol	Type	Cv	Operator	Voltage	Non-Locking	Locking
	4-way, 2-position, spring return	4.8	Single solenoid	24 VDC 110 VAC	L6753810249 L6753810253	L6753910249 L6753910253
	4-way, 2-position	4.8	Double solenoid	24 VDC 110 VAC	L6553810249 L6553810253	L6553910249 L6553910253
	4-way, 3-position, all ports blocked	4.8	Double solenoid	24 VDC 110 VAC	L6653821149 L6653821153	L6653921149 L6653921153
	4-way, 3-position, center exhaust	4.8	Double solenoid	24 VDC 110 VAC	L6653822149 L6653822153	L6653922149 L6653922153
	4-way, 3-position, pressure center	4.8	Double solenoid	24 VDC 110 VAC	L6653823149 L6653823153	L6653923149 L6653923153

* Order subbase or manifold separately.

3/8" Basic plug-in remote pilot valve only

Symbol	Type	Cv	Operator	Part Number
	4-way, 2-position, spring return	4.8	Single remote	L67431102
	4-way, 2-position	4.8	Double remote	L65431102
	4-way, 3-position, all ports blocked	4.8	Double remote	L66431211
	4-way, 3-position, center exhaust	4.8	Double remote	L66431221
	4-way, 3-position, pressure center	4.8	Double remote	L66431231

* Order subbase or manifold separately.

3/8" Valve Subbase and Manifolds

	Cv	Port	Subbase † (side ports)	Manifolds † (end & bottom ports)
Subbase	4.8	3/8"	K022090	K142230
Manifold	4.8	1/2"	K022091	K142231
	4.8	3/4"	K022101	K142270

† Manifolds include mounting hardware, except for port adapters. Subbase includes valve mounting hardware.

Plug-in Subbase, 3/8" Basic

K022090Inlet & Cylinder Ports 3/8" NPTF
	Exhaust ports 1/2" NPTF
K022091Inlet & Cylinder Ports 1/2" NPTF
	Exhaust ports 1/2" NPTF
K022101Inlet & Cylinder Ports 3/4" NPTF
	Exhaust port 3/4" NPTF
	Conduit port 1/2" NPTF

Note: Subbase assemblies include mounting hardware.

Most popular.

Plug-in Manifold, 3/8" Basic

K142230Cylinder ports 3/8" NPTF
K142231Cylinder ports 1/2" NPTF
K142270Cylinder ports 3/4" NPTF
	Exhaust port..... 1" NPTF
	Inlet port..... 1" NPTF
	Conduit port..... 1-1/4" NPTF

Note: Manifold assemblies include mounting hardware.





D
Subbase & Manual Valves
H Series Micro
Modulflex Series
H Series ISO
Network Connectivity
DX ISOMAX Series
Valvair II Series



For inventory, lead times, and kit lookup, visit www.pdnplu.com



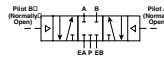

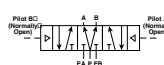
Common Part Numbers

1" Basic plug-in solenoid valve only with light

Symbol	Type	Cv	Operator	Voltage	Non-Locking	Locking
	4-way, 2-position, spring return	11.3	Single solenoid	24 VDC 110 VAC	L6758810249 L6758810253	L6758910249 L6758910253
	4-way, 2-position	11.3	Double solenoid	24 VDC 110 VAC	L6558810249 L6558810253	L6558910249 L6558910253
	4-way, 3-position, all ports blocked	11.3	Double solenoid	24 VDC 110 VAC	L6658821149 L6658821153	L6658921149 L6658921153
	4-way, 3-position, center exhaust	11.3	Double solenoid	24 VDC 110 VAC	L6658822149 L6658822153	L6658922149 L6658922153
	4-way, 3-position, pressure center	11.3	Double solenoid	24 VDC 110 VAC	L6658823149 L6658823153	L6658923149 L6658923153

* Order subbase separately.

1" Basic plug-in valve remote pilot valve only

Symbol	Type	Cv	Operator	Part Number
	4-way, 2-position, spring return	11.3	Single remote	L67481102
	4-way, 2-position	11.3	Double remote	L65481102
	4-way, 3-position, all ports blocked	11.3	Double remote	L66481211
	4-way, 3-position, center exhaust	11.3	Double remote	L66481221
	4-way, 3-position, pressure center	11.3	Double remote	L66481231

* Order subbase separately.

1" Valve Subbase

	Cv	Port	Subbase † (side ports)
	11.3	1"	K022095

Subbase

† Subbase includes valve mounting hardware.

Plug-in Subbase, 1" Basic

K022095 Inlet & Cylinder Ports 1" NPTF
 Exhaust ports 1-1/4" NPTF
 Conduit port 1/2" NPTF

Note: Subbase assemblies include mounting hardware.



For inventory, lead times, and kit lookup, visit www.pdnplu.com

D273

Parker Hannifin Corporation
 Pneumatic Division
 Richland, Michigan
www.parker.com/pneumatics

D

Subbase & Manual Valves

H Series Micro

Modulflex Series





H Series ISO

Network Connectivity

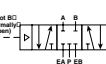
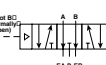

DX ISOMAX Series

Valvair II Series

3/8" Basic direct pipe ported valve only. Solenoid junction box with light, 1/2" NPT ports

Symbol	Type	Cv	Operator	Voltage	Non-Locking	Locking
	4-way, 2-position, spring return	4.8	Single solenoid	24 VDC 110 VAC	L7054810249	L7054910249
	4-way, 2-position	4.8	Double solenoid	24 VDC 110 VAC	L6854810249	L6854910249
	4-way, 3-position, all ports blocked	4.8	Double solenoid	24 VDC 110 VAC	L6954821149	L6954921149
	4-way, 3-position, center exhaust	4.8	Double solenoid	24 VDC 110 VAC	L6954822149	L6954922149
	4-way, 3-position, pressure center	4.8	Double solenoid	24 VDC 110 VAC	L6954823149	L6954923149

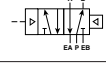
3/8" Basic direct pipe ported remote pilot valve only, 1/2" NPT ports

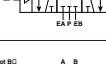
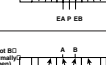
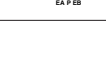
Symbol	Type	Cv	Operator	Part Number
	4-way, 2-position, spring return	4.8	Single remote	L70441102
	4-way, 2-position	4.8	Double remote	L68441102
	4-way, 3-position, all ports blocked	4.8	Double remote	L69441211
	4-way, 3-position, center exhaust	4.8	Double remote	L69441221
	4-way, 3-position, pressure center	4.8	Double remote	L69441231

D
Subbase & Manual Valves
H Series Micro
Modulflex Series
H Series ISO
Network Connectivity
DX ISOMAX Series
Valvair II Series

 Most popular.







For inventory, lead times, and kit lookup, visit www.pdnplu.com

D274





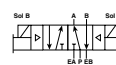

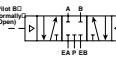
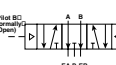
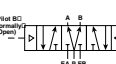
Parker Hannifin Corporation
Pneumatic Division
Richland, Michigan
www.parker.com/pneumatics

Common Part Numbers

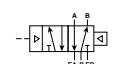
1" Basic direct pipe ported valve only. Solenoid junction box with light, 1" NPT ports

Symbol	Type	Cv	Operator	Voltage	Non-Locking	Locking
		4-way, 2-position, spring return	11.3	Single solenoid	24 VDC 110 VAC	L7058810249 L7058910249
		4-way, 2-position	11.3	Double solenoid	24 VDC 110 VAC	L6858810249 L6858910249
		4-way, 3-position, all ports blocked	11.3	Double solenoid	24 VDC 110 VAC	L6958821149 L6958921149
		4-way, 3-position, center exhaust	11.3	Double solenoid	24 VDC 110 VAC	L6958822149 L6958922149
		4-way, 3-position, pressure center	11.3	Double solenoid	24 VDC 110 VAC	L6958823149 L6958923149

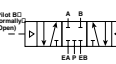
1" Basic direct pipe ported remote pilot valve only. 1" NPT ports

Symbol	Type	Cv	Operator	Part Number	
		4-way, 2-position, spring return	11.3	Single remote	L70481102
		4-way, 2-position	11.3	Double remote	L68481102
		4-way, 3-position, all ports blocked	11.3	Double remote	L69481211
		4-way, 3-position, center exhaust	11.3	Double remote	L69481221
		4-way, 3-position, pressure center	11.3	Double remote	L69481231



For inventory, lead times, and kit lookup, visit www.pdnplu.com

D275

Parker Hannifin Corporation
Pneumatic Division
Richland, Michigan
www.parker.com/pneumatics

D

Subbase & Manual Valves

H Series Micro

Modulflex Series

H Series ISO

Network Connectivity

DX ISOMAX Series

Valvair II Series

Lubricated Non-Lubricated Service
2-position, Plug-In, 3/8" & 1" Basic Size

L 67 5 3 9 10 2 53

Type	
Double	65
Single	67

Operator	
Remote	4
Solenoid	5

Size	
3/8" Basic	3
1" Basic	8

Operator options	
Solenoid (basic) or Remote	1
Solenoid with Locking Override	3
Solenoid w/Light (120VAC, 24VDC) & Non-Locking Override	8
Solenoid w/Light (120VAC, 24VDC) & Locking Override	9

Voltage & Frequency			
	60Hz	50Hz	DC
45			12
49			24
53	120	110	
57	240	220	
Blank	Remote		

Duty Cycle	
2	Standard Service, Solenoid or Remote
4	Continuous Service Solenoid

Enclosure "Class"	
10	Standard (NEMA 1 & 12) or Remote

D
 Subbase & Manual Valves
 H Series Micro
 Modulflex Series
 H Series ISO
 Network Connectivity
 DX ISOMAX Series
 Valvair II Series

Lubricated or Non-Lubricated Service
3-position, Plug-In, 3/8" & 1" Basic Size

L 66 5 3 9 21 1 53

Type	
Double	66

Operator	
Remote	4
Solenoid	5

Size	
3/8" Basic	3
1" Basic	8

Operator options	
Solenoid (basic) or Remote	1
Solenoid with Locking Override	3
Solenoid w/Light (120VAC, 24VDC) & Non-Locking Override	8
Solenoid w/Light (120VAC, 24VDC) & Locking Override	9

Voltage & Frequency			
	60Hz	50Hz	DC
45			12
49			24
53	120	110	
57	240	220	
Blank	Remote		

Duty Cycle	
1	Standard Service, Solenoid or Remote
5	Continuous Service Solenoid

Enclosure "Class"	
21	All Ports Blocked In Neutral (NEMA 1 & 12 enclosure) or Remote
22	Cyl. Ports Open to Exhaust in Neutral (NEMA 1 & 12 enclosure) or Remote
23	Cyl. Ports Open to Inlet in Neutral (NEMA 1 & 12 enclosure) or Remote

Most popular.



For inventory, lead times, and kit lookup, visit www.pdnplu.com

D276

Parker Hannifin Corporation
 Pneumatic Division
 Richland, Michigan
www.parker.com/pneumatics

Ordering Information

Lubricated or Non-Lubricated Service
2-position, Direct Pipe Ported, 3/8" & 1" Basic Size

L	70	5	3	9	10	2	53	—
----------	-----------	----------	----------	----------	-----------	----------	-----------	----------

Type	
Double	68
Single	70

Operator	
Remote	4
Solenoid	5

Size	
3/8" NPT Inlet & Cylinder 1/2" NPT Exhaust	3
1/2" NPT Inlet, Cylinder & Exhaust	4
1" NPT Inlet & Cylinder 1-1/4" NPT Exhaust	8
1-1/4" NPT Inlet Cylinder & Exhaust	9*

Operator options	
Solenoid (basic) or remote	1
Solenoid with locking override	3
Solenoid w/ junction box & locking override	6
Solenoid w/ junction box & light (120VAC, 24VDC) & non-locking override	8
Solenoid w/ junction box & light (120VAC, 24VDC) & locking override	9

Lead Length	
Blank	19" (Standard)

Voltage & Frequency			
	60Hz	50Hz	DC
45			12
49			24
53	120	110	
57	240	220	
Blank	Remote		

Duty Cycle	
2	Standard Service, Solenoid or Remote
4	Continuous Service Solenoid

Enclosure "Class"	
10	Standard (NEMA 1 & 12) or Remote
60*†	Hazardous Duty (NEMA 7 & 9)
80†	NEMA 4

* Not available operator option 4 - Remote pilot.

* Voltage 49 / 53 only.
† Use with operator options 1 & 3 only.

Lubricated or Non-Lubricated Service
3-position, Direct Pipe Ported, 3/8" & 1" Basic Size

L	69	5	3	9	21	1	53	—
----------	-----------	----------	----------	----------	-----------	----------	-----------	----------

Type	
Double	69

Operator	
Remote	4
Solenoid	5

Size	
3/8" NPT Inlet & Cylinder 1/2" NPT Exhaust	3
1/2" NPT Inlet, Cylinder & Exhaust	4
1" NPT Inlet & Cylinder 1-1/4" NPT Exhaust	8
1-1/4" NPT Inlet Cylinder & Exhaust	9*

Operator Options	
Solenoid (basic) or Remote	1
Solenoid with Locking Override	3
Solenoid w/ Junction Box & Locking Override	6
Solenoid w/ Junction Box & Light (120VAC, 24VDC) & Non-Locking Override	8
Solenoid w/ Junction Box & Light (120VAC, 24VDC) & Locking Override	9

Lead Length	
Blank	19" (Standard)

Voltage & Frequency			
	60Hz	50Hz	DC
45			12
49			24
53	120	110	
57	240	220	
Blank	Remote		

Duty Cycle	
1	Standard Service, Solenoid or Remote
5	Continuous Service Solenoid

Enclosure "Class"	
All Ports Blocked in Neutral	
21	Standard (NEMA 1 & 12) or Remote
71*†	Hazardous Duty (NEMA 7 & 9)
91†	NEMA 4
Cylinder Ports Open to Exhaust in Neutral	
22	Standard (NEMA 1 & 12) or Remote
72*†	Hazardous Duty (NEMA 7 & 9)
92†	NEMA 4
Cylinder Ports Open to Inlet in Neutral	
23	Standard (NEMA 1 & 12) or Remote
73*†	Hazardous Duty (NEMA 7 & 9)
93†	NEMA 4

* Not available operator option 4 - Remote pilot.

* Voltage 49 / 53 only.
† Use with operator options 1 & 3 only.

Most popular.



For inventory, lead times, and kit lookup, visit www.pdnplu.com

D277

Parker Hannifin Corporation
Pneumatic Division
Richland, Michigan
www.parker.com/pneumatics

D

Subbase & Manual Valves

H Series Micro

Modulflex Series

H Series ISO

Network Connectivity

DX ISOMAX Series

Valvair II Series

Modular Pneumatic Controls Plug-In Sandwich Block Design for Modular Port Regulation

These modular regulators assemble to any 3/8" basic valve interface pattern.

Port Regulation Made Easy

Place the sandwich on the manifold or subbase, tighten the four securing screws, then plug the valve into the sandwich and tighten its securing screws to complete the assembly.

Within minutes, these modular components can be installed in new, or used to improve existing manifold systems, without disturbing wiring or air connections.

3-Configurations

1. **Common Port Regulation** - A common regulated pressure is selected to both cylinder ports.
2. **Single Port Regulation** - Line pressure is available to one cylinder port, while a single regulated pressure is selected to the other cylinder port.
3. **Independent Port Regulation** - Two independently regulated pressures selected to the cylinder ports.

NOTE: When using single or independent port sandwich regulators, be aware that:

1. Cylinder port outlets are reversed.
2. 3-Position, cylinder ports open to exhaust and cylinder ports open to inlet functions are reversed. To produce a cylinder ports open to exhaust function, order valve with cylinder ports open to inlet. To produce a cylinder ports open to inlet function, order valve with cylinder ports open to exhaust.

Manual or Remote secondary pressure adjustment.

Three Pressure Ranges are standard for manual units:

- 1-30 PSIG
- 1-60 PSIG
- 2-125 PSIG

Range for Remote: 0-140 PSIG

Gauges are furnished standard; liquid filled gauges are optional.



Solenoid Valve Assembly

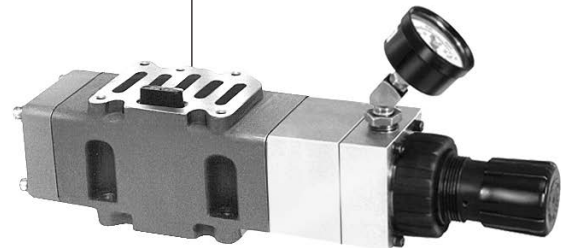

Regulator Assembly

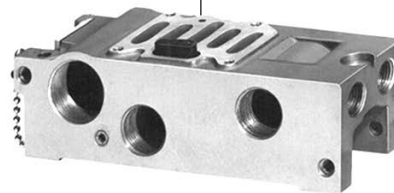

Manifold

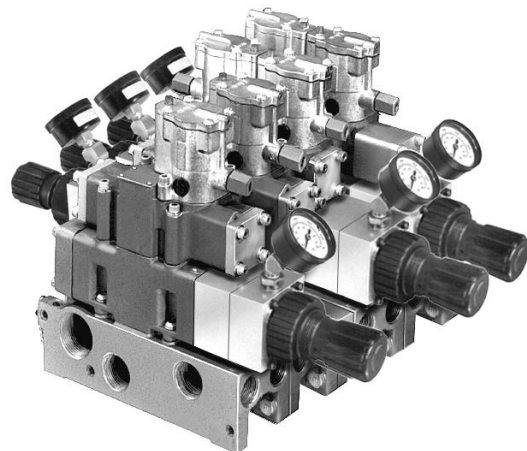

Typical Assembly

D
 Subbase & Manual Valves
 H Series Micro
 Modulflex Series
 H Series ISO
 Network Connectivity
 DX ISOMAX Series
 Valvair II Series



For inventory, lead times, and kit lookup, visit www.pdnplu.com

Function - Single Port Regulation

This modular air pressure regulator assembly, when installed between a 3/8" basic, 4-Way valve and subbase or modular manifold, supplies one or more regulated pressures to one of the valve cylinder ports and supply pressure to the other cylinder port.

On Single Port Cylinder Port Regulation Units controlled by a single solenoid valve, cylinder port "B" is the normally open cylinder port. The solenoid is energized to open cylinder Port "A". On double solenoid operated valves, energizing solenoid "B" opens cylinder port "A" and energizing solenoid "A" opens cylinder port "B".

Valve must be converted to external pilot supply.

Features

Regulated pressure output from the valve is adjusted by knob on the manually set model or by air pressure signal applied to the regulator pilot port on the remotely set model.

For reduced pressure at "A" cylinder port, the regulator is mounted per assembly "A" on end opposite the electrical junction box. For reduced pressure at "B" cylinder port the regulator is mounted per Assembly "B" which places the regulator over the electrical junction box.

Furnished with pressure gauge as standard.

Pressure Range Options

Maximum Supply Pressure	140 PSIG
Output Pressure Range	1 - 30 PSIG
	1 - 60 PSIG
	2 - 125 PSIG

Operating Temperature Range

32°F (0°C) to 175°F (79°C)

How To Order

1. Select type of adjustment.
2. Select pressure range.
3. Select assembly style.

Example: Manual adjustment.
 5-60 PSIG, Port A reduced.

Model No. L55405307C

Relief and Flow Characteristics

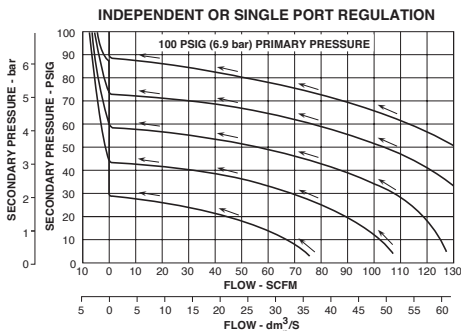

The above curves illustrate flow characteristics through an assembled valve, air regulator, and base (or modular manifold) unit.

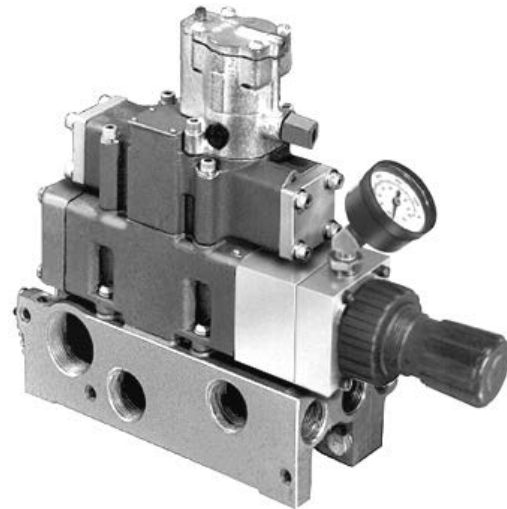

Assembly "A"

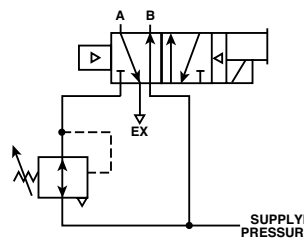

Supply Pressure at "B" & Regulated at "A"

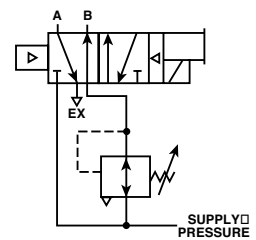

Supply Pressure at "A" & Regulated at "B"

Pressure Adjustment	Pressure Range PSIG	Model Number	
		Reduced Pressure Cyl. Port "A"	Cyl. Port "B"
Manual	1 - 60	L55405307C	L55407305C
	2 - 125	L55406307C	L55407306C
Remote	0 - 140	L55414307C	L55407314C

Note: When using single or independent port sandwich regulators, be aware that:

1. Cylinder port outlets are reversed.
2. 3-Position, cylinder ports open to exhaust and cylinder ports open to inlet functions are reversed. To produce a cylinder ports open to exhaust function, order valve with cylinder ports open to inlet. To produce a cylinder ports open to inlet function, order valve with cylinder ports open to exhaust.

See parts and accessories for gauges.

D
 Subbase & Manual Valves
 H Series Micro
 Moduteflex Series
 H Series ISO
 Network Connectivity
 DX ISOMAX Series
 Valvair II Series



For inventory, lead times, and kit lookup, visit www.pdnplu.com

Manual Adjusting

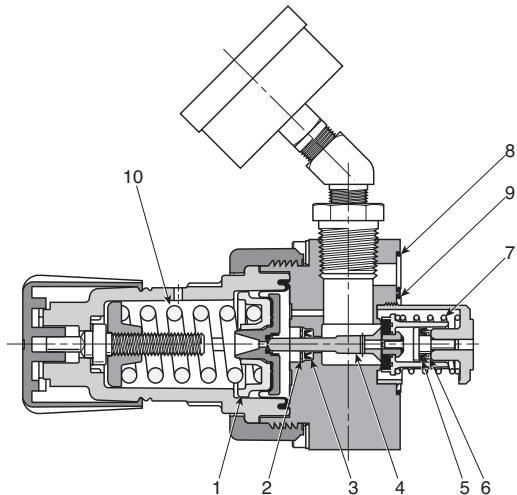

Remote Operated

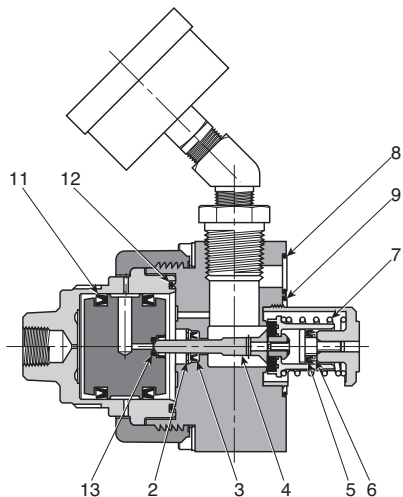

Replacement Parts

Item no.	Part Number	Description
1	○	Diaphragm Assembly
2	○ ●	Retaining Ring
3	○ ●	Vee Packing
4	○ ●	Poppet Assembly
5	○ ●	Vee Packing
6	○ ●	Backflow Retainer
7	○ ●	Poppet Spring
8	○ ●	.989 ID x .070 W O-Ring
9	○ ●	1.301 ID x .070 W O-Ring
	P01698	1-30 PSI Spring
10	P04062	1-60 PSI Spring (Blue)
	P04063	2-125 PSI Spring
11	●	Vee Packing
12	●	1.674 ID x .103 W O-Ring
13	●	Vent Seal

○ Parts included in K352409 service kit for manual operated modular regulators.

● Parts included in K352411 service kit for remote operated modular regulators.

Replacement Gauges

PSIG	Standard
0-60	K4520N14060
0-160	K4520N14160
0-300	K4520N14300

Suggested Schematic of Assembled Valve, Air Regulation and Modular Manifold Units

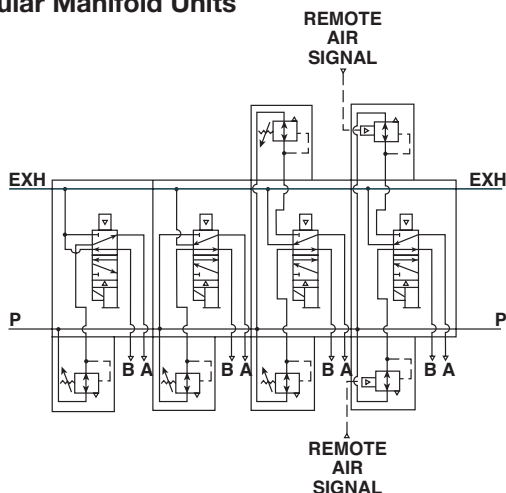

D

Subbase & Manual Valves

H Series Micro

Modulflex Series

H Series ISO

Network Connectivity

DX ISOMAX Series

Valvair II Series



For inventory, lead times, and kit lookup, visit www.pdnplu.com

Common Port Regulation

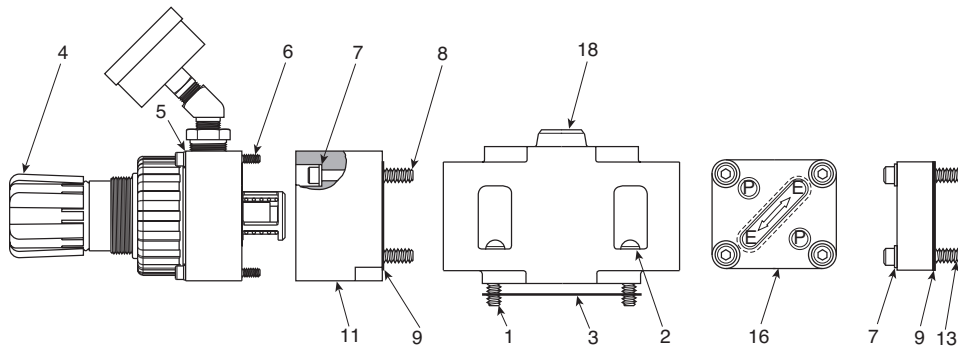

Single Port Regulation

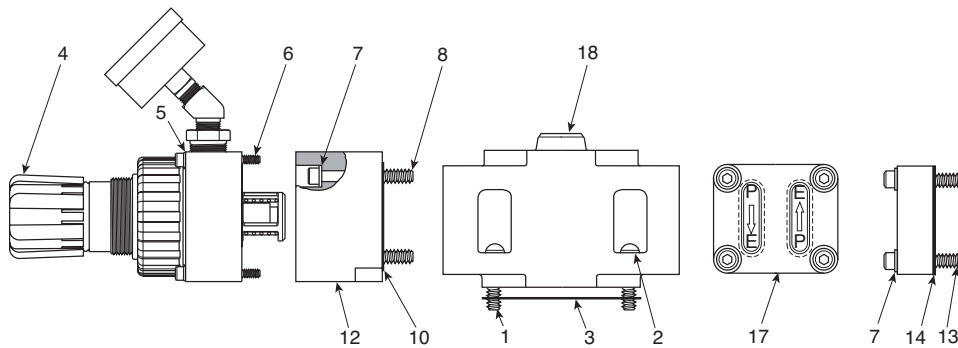

Independent Port Regulation

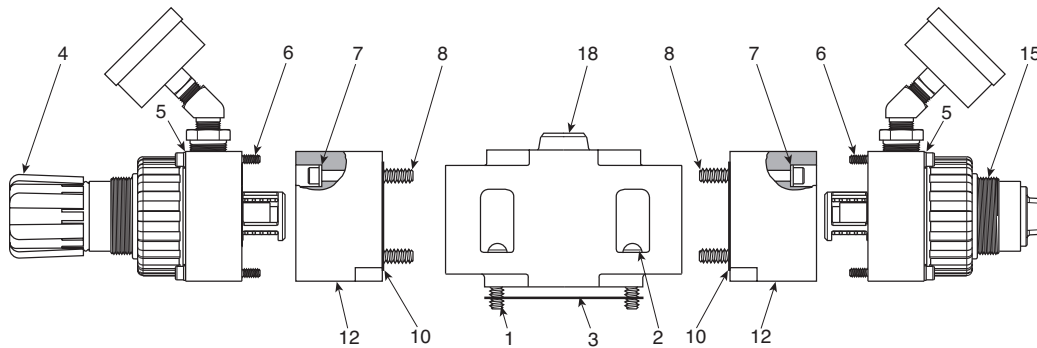

Table "E": Parts

Item No.	Part Number	Description
1	H09815	Screw (4)
2	H17512	Lockwasher (4)
3	K183077	Gasket
4	Standard	Manual Reg. Assy. (w/Gauge)
	K472001C	1-30 PSIG
	K472002C	1-60 PSIG
5	K472003C	2-125 PSIG
	H17509	#10 Lockwasher
	H10032	#10-32 x 1.75" Lg. SHCS
7	H17511	1/4" Lockwasher
8	H10069	1/4-20 x 2.25" Lg. SHCS

Item No.	Part Number	Description
9	K183082	Gasket
10	K183084	Gasket
11	K043012	Function Block (P to P)
12	K043011	Function Block (P to E)
13	H100107	1/4-20 x 1-1/2" Lg. SHCS
14	K183083	Gasket
15	Standard	Remote Reg. Assy. (w/Gauge)
	K472009C	0-140 PSIG
16	K362308	Function Plate Assy. (Incl. 7, 9, 13)
17	K362307	Function Plate Assy. (Incl. 7, 13, 14)
18	K032270	Body Assy. (Incl. 1, 2, 3)



For inventory, lead times, and kit lookup, visit www.pdnplu.com

D283

Parker Hannifin Corporation
 Pneumatic Division
 Richland, Michigan
www.parker.com/pneumatics

D

Subbase & Manual Valves

H Series Micro

Modulflex Series

H Series ISO

Network Connectivity

DX ISOMAX Series



Valvair II Series

Plug-in Pilot

	Description	Standard Service		Special Service	
	Override type	Locking	Non-locking	Locking	Non-locking
With indicator light	With override (120VAC)	K175903553	K175803553	K185902553	K185802553
	With override (Other than 120VAC)	K1753035**	—	K1853025**	—



** Voltage code - (reference model index for availability)

NEMA 1 & 12

	Description	Standard Service		Special Service	
	Override type	Locking	Non-locking	Locking	Non-locking
Basic Pilot	Basic with override	K0653035**	—	K0853025**	—
	JIC with junction box & override	K0656035**	K0655035**	K0856025**	K0855025**
	JIC pilot with junction box & override & indicator lights (120VAC Only)	K0659035**	K0658035**	K0859025**	K0858025**

** Voltage code - (reference model index for availability)

NEMA 4, 7 & 9

	Description	Standard Service		Special Service	
	Override type	Locking	Non-locking	Locking	Non-locking
Hazardous Duty	Hazardous duty pilot - UL & CSA	K0251035**†	—	K0451025**†	—
	NEMA 4 pilot	K2351035**†	—	—	—
	Hazardous duty with override	K0253035**†	K0252035**†	K0453025**†	K0452025**†
	NEMA 4 with override	—	K2353035**†	K2352035**†	—

† 49 / 53 only ** Voltage code - (reference model index for availability)

Replacement Solenoid Coil



Voltage Code	Voltage			Coil Number	
	60 Hz	50 Hz	DC	Plug-In	Flying lead (19") *
49	—	—	24 [†]	K593060 K593274[‡]	K593014
53	120 [†]	110	—	K593071 K593125[‡]	K593025
57	240 [†]	220	—	K593081	K593035

Notes: **Bold Face** type indicated primary coil rating.
 † Indicates voltages approved for solenoid operators designed for use in hazardous locations.
 * 19" Coil lead length is standard. Other lead lengths may be available, consult supplier.
 ‡ Assembly includes indicator light socket, less light.

Solenoid Characteristics Chart
Voltage Range +10/-15% of Nominal

3/8" & 3/4" Basic - L-Pilot

Voltage/Cycles	Amps Inrush	Amps Holding	Resistance Ohms	Watts	Insulation Class
120/60VAC	.29	.18	122	12	B
110/50VAC	.21	.14	122	12	B
240/60VAC	.18	.12	610	12	B
24/60VAC	1.6	1.0	4.5	9.5	B
24/50VAC	1.2	.75	6.4	9.5	B
6VDC	—	1.4	4.5	7.6	B
12VDC	—	.66	17.7	9	B
24VDC	—	.32	71	9	B
48VDC	—	.22	216	11	B

D
 Subbase & Manual Valves
 H Series Micro
 Modutefx Series
 H Series ISO
 Network Connectivity
 DX ISOMAX Series
 Valvair II Series



For inventory, lead times, and kit lookup, visit www.pdnplu.com

Service Kits

To use this chart you must know the basic valve series, quantity, and type of operators, or the first three characters of the valve model number.

Basic Valve	Solenoid Operated *						
	Series (prefix)	Standard Service (intermittent duty)		Special Service ** (continuous duty)		Remote Pilot Operated	
Size		Single	Double 2 & 3-Position	Single	Double 2 & 3-Position	Single	Double 2 & 3-Position
3/8"	L65	—	K352126	—	K352127	—	K352355
	L66	—	K352126	—	K352127	—	K352355
	L67	K352124	—	K352125	—	K352362	—
	L68	—	K352126	—	K352127	—	K352355
	L69	—	K352126	—	K352127	—	K352355
	L70	K352124	—	K352125	—	K352362	—
	L70	K352128	—	K352129	—	K352359	—
1"	L65	—	K352130	—	K352131	—	K352360
	L66	—	K352130	—	K352131	—	K352360
	L67	K352128	—	K352129	—	K352359	—
	L68	—	K352130	—	K352131	—	K352360
	L69	—	K352130	—	K352131	—	K352360
	L70	K352128	—	K352129	—	K352359	—
	L70	K352128	—	K352129	—	K352359	—

Notes:

* Kits for solenoid operated valves include solenoid service kits.

** Special service (continuous duty) solenoids may be identified as having gold colored solenoid tops.

Blank Plate Kit - 3/8" Basic

Manifold Assembly	Port size	Part Number
K142230	3/8"	K06020003
K142231	1/2"	
K142270	3/4"	

Kit includes: Blank plate, gasket, mounting screws.

Conversion Kits: Lubricated to Non-Lubricated Operation

Basic Size	Operators (solenoid or remote pilot)	
	Single	Double (2-position)
3/8"	K322012	K322013

Flush Type Hex Drive Pipe Plugs for Port Isolation

Size (NPTF)	Part Number
1/8"	K21R02012L
1/4"	K21R02025L
3/8"	K21R02037L
1/2"	K21R02050L
3/4"	K21R02075L

Electrical Connectors Single or Double Solenoid Valves

Basic Size	Valve Body		Subbase / Manifold	
	Single Solenoid	Double Solenoid	10" Leads	72" Leads
3/8"	H02723	H02722	H02713	H02789
1"				

Interchangeable Manual Override Assemblies for Solenoid Operators



Non-Locking Type	Locking Type
K162001	K152003

To override valve, use a flat head screwdriver to press in and rotate plunger 90° until plunger locks in place. For proper valve operation, override should be in the out position.



For inventory, lead times, and kit lookup, visit www.pdnplu.com

D285

Parker Hannifin Corporation
 Pneumatic Division
 Richland, Michigan
www.parker.com/pneumatics

D

Subbase & Manual Valves

H Series Micro

Modulflex Series

H Series ISO

Network Connectivity

DX ISOMAX Series

Valvair II Series

Plug-In
 De-Energized

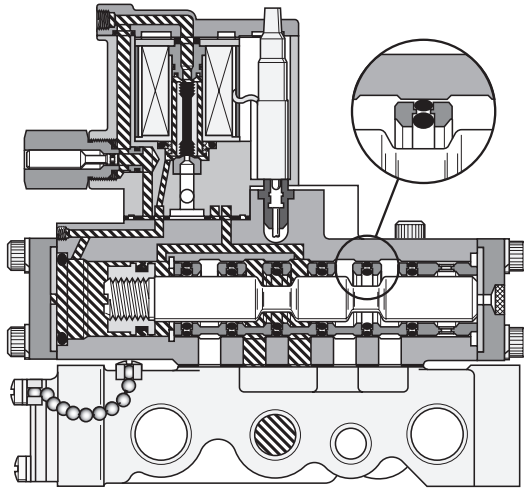

Direct Pipe Ported
 De-Energized

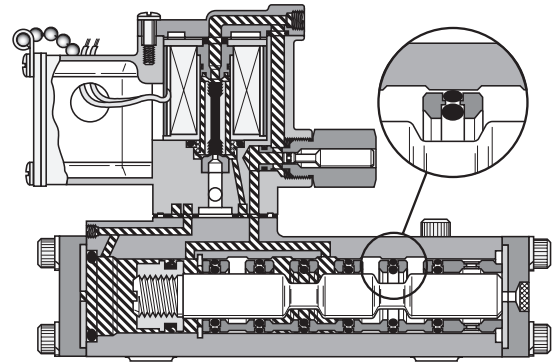

Energized

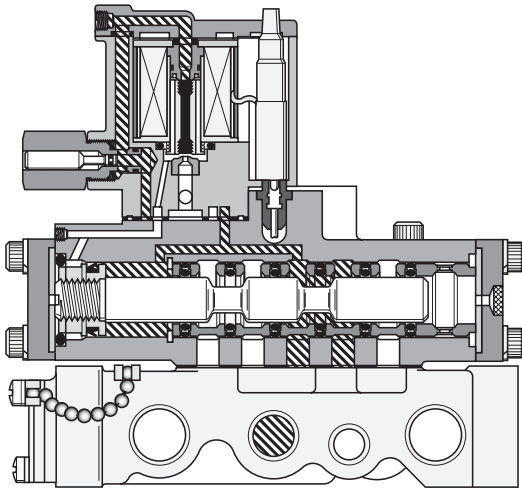

Energized

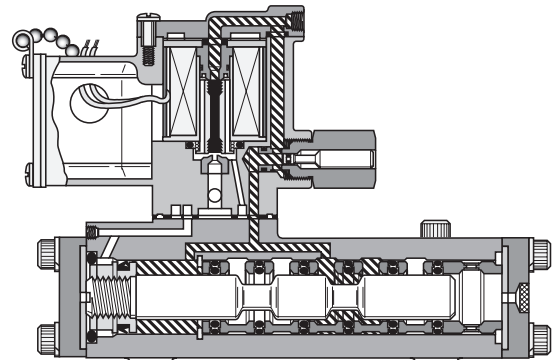

 **Pressure**  **Exhaust**

D	Subbase & Manual Valves
H Series Micro	
Modulflex Series	
H Series ISO	
Network Connectivity	
DX ISOMAX Series	
Valvair II Series	



For inventory, lead times, and kit lookup, visit www.pdnplu.com

D286

Parker Hannifin Corporation
 Pneumatic Division
 Richland, Michigan
www.parker.com/pneumatics

Flow Capacities

Valve Type	Cylinder Port Size (NPTF)	Mounting Style	Cv Flow Rating Inlet to Cylinder "A"
3/8" Single	3/8"	Direct Pipe	4.7
	1/2"	Direct Pipe	5.3
3/8" Double	3/8"	Direct Pipe	4.5
	1/2"	Direct Pipe	5.5
	3/4"	Subbase	5.0
	3/4"	Manifold	4.9
3/8" Double 3-Position	3/8"	Direct Pipe	4.1
	1/2"	Direct Pipe	4.5
	3/4"	Subbase	4.5
	3/4"	Manifold	4.1
1" Single & Double	1"	Direct Pipe	12.0
		Subbase	11.3

Recommended Filtration

Maintained 40 Micron Filtration

Life Expectancy

Valves designed for non-lubricated service as well as those designed for lubricated service will provide millions of maintenance free cycles. Under laboratory conditions service life exceeds 25,000,000 cycles.

Factory Pre-Lubrication

Valves are lubricated at assembly with Sunaplex 781 or equivalent. Valves specified for vacuum service are lubricated with Dow Corning Valve Seal A.

Valves for Non-Lubricated Service

3/8" basic valve sizes are designed to operate in applications where in-service lubrication is not desirable. Valves are factory pre-lubed as noted above. These valves may be used for lubricated service as well.

Lubrication

Air Line Lubricant (compatible with Nitrile & Polyurethane seals) must readily atomize and be of the medium aniline type. Aniline point range must be between 180° and 220°F. Viscosity @ 100°F: 140-170 SUS.

Recommended Lubricant

If in-service lubrication is required, use F442 oil, or equivalent. F442 is specially formulated to provide peak performance and maximum service life for air operated equipment.

Subbase & Manifold Valve Products Valvair II Series

Listing Agencies

General Purpose Approvals

CSA - Canadian Standards Association
 File Number 42024

Hazardous Duty Approvals

UL - Underwriters Laboratories, Inc.
 File Number E42542
 Category Y107

CSA - Canadian Standards Association
 File Number 24349

Solenoid Enclosure Ratings

Type	Listing Agency	NEMA Rating	Description
Plug-In	CSA	1 & 12	General purpose indoor only dust tight
Conduit / flying lead	CSA	1 & 12	General purpose indoor only dust tight
* Conduit (as specified)	UL & CSA	7 & 9	Hazardous location see chart below)
* Conduit (as specified)	CSA	4	General purpose indoor / outdoor

* See ordering information on specific valve type. (Direct Pipe Ported Valves Only.)

Hazardous Duty Solenoid Listing

Valves with solenoid operators designated for hazardous locations are UL & CSA Approved as follows:

National Electric Code	Ambient Conditions	NEMA Classification
Class I Div. 1 Group C	Ethyl, Ether, Etc., Gases & Vapors	VII (7)
Class I Div. 1 Group D	Gasoline, Etc., Gases & Vapors	VII (7)
Class I Div. 2 Group B	Butadiene, Etc., Liquid, Fluid or Vapor Normally Contained, or Atmosphere Ventilated	VII (7)
Class II Div. 1 Group E	Metal Dust	IX (9)
Class II Div. 1 Group F	Coal, Coke, Carbon Black Dust	IX (9)
Class II Div. 1 Group G	Flour, Starch, Grain Dust	IX (9)

See Article 500 - Hazardous (Classified) Locations, National Electric Code.



For inventory, lead times, and kit lookup, visit www.pdnplu.com

D287

Parker Hannifin Corporation
 Pneumatic Division
 Richland, Michigan
www.parker.com/pneumatics

D

Subbase & Manual Valves

H Series Micro

Moduflex Series

H Series ISO

Network Connectivity

DX ISOMAX Series

Valvair II Series

Installation

Valves should be installed with reasonable accessibility for service. Exercise care in keeping piping lengths to a minimum. Piping should be free of dirt, chips & scale. Pipe joint compound should be used sparingly applied only to the thread, never to the valve body. Avoid undue strain at piping joints. Protect the valve from exposure to extreme temperatures, dirt and moisture to maximize life.

Note: Valves equipped with locking manual overrides. Override(s) must be in the fully extended position for proper valve operation.

Double Solenoid / Remote Caution

Note: It is recommended that double solenoid and double remote 2-Position valves be mounted with the main spool in the horizontal plane.

Wiring Instructions for Base Mounted Valves

Single Solenoid:

Use wires marked "2" & "3" for connection. Units with DC Solenoids and indicator lights are polarity sensitive. Wire marked "3" is positive (+).

Double Solenoid:

Use wires marked "1" & "2" for Solenoid "A". Use wires marked "3" & "4" for Solenoid "B". Units with DC Solenoids and indicator lights are polarity sensitive. Wires marked "1" and "3" are positive.

CAUTION:
 DC Solenoids are polarity sensitive.
 Observe polarities indicated above.

Units with Flying Leads

Wires are not polarity sensitive.

CAUTION:
 DC solenoids with indicator lights and / or arc suppression coils are polarity sensitive. Use red wire as positive.

"Special Service" Solenoid (Continuous Duty)

Special Service Solenoids are designed for use when the solenoid duty cycle is greater than 70% or when energization times are for 10 minutes or longer.

These solenoids should be used when valves are to be held energized for hours, days or weeks... or when extended ambient temperature operation is required. Apply the duty cycle formula to determine if this type of solenoid is required.

Duty Cycle Formula

$$\frac{\text{Time Energized}}{\text{Time Energized} + \text{Time Off}} \times 100 = \% \text{ Duty Cycle}$$

If Duty Cycle is 70% or greater, then Special Service (Continuous Duty) Solenoid should be used.

Pilot Supply Conversion

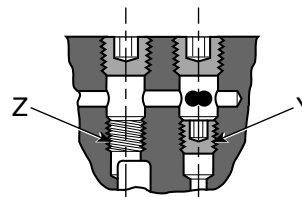

Base Mounted

For field conversion to external pilot supply, remove two 1/8" NPTF plugs from top of valve body and move bottom plug from "Y" to "Z".

Replace 1/8" NPTF plugs and connect pilot pressure to the 1/4" NPTF external pilot supply port "X" in subbase.

Direct Pipe Ported

For field conversion to external pilot supply, remove and discard 1/4" NPTF plug in external pilot supply port "X". Move stored plug "Y" to location "Z" in bottom of pilot supply port "X". Then connect pilot pressure to port "X" in valve body.

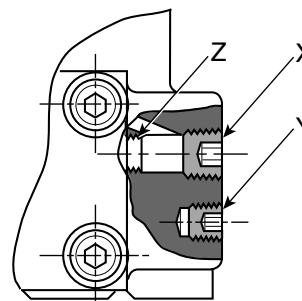

D	Subbase & Manual Valves
	H Series Micro
H Series	Modulflex Series
	ISO
Network Connectivity	DX ISOMAX Series
	Valvair II Series



For inventory, lead times, and kit lookup, visit www.pdnplu.com

* Assembly "A" places the regulator on the end opposite the electrical junction box. Assembly "B" places the regulator over the electrical junction box.

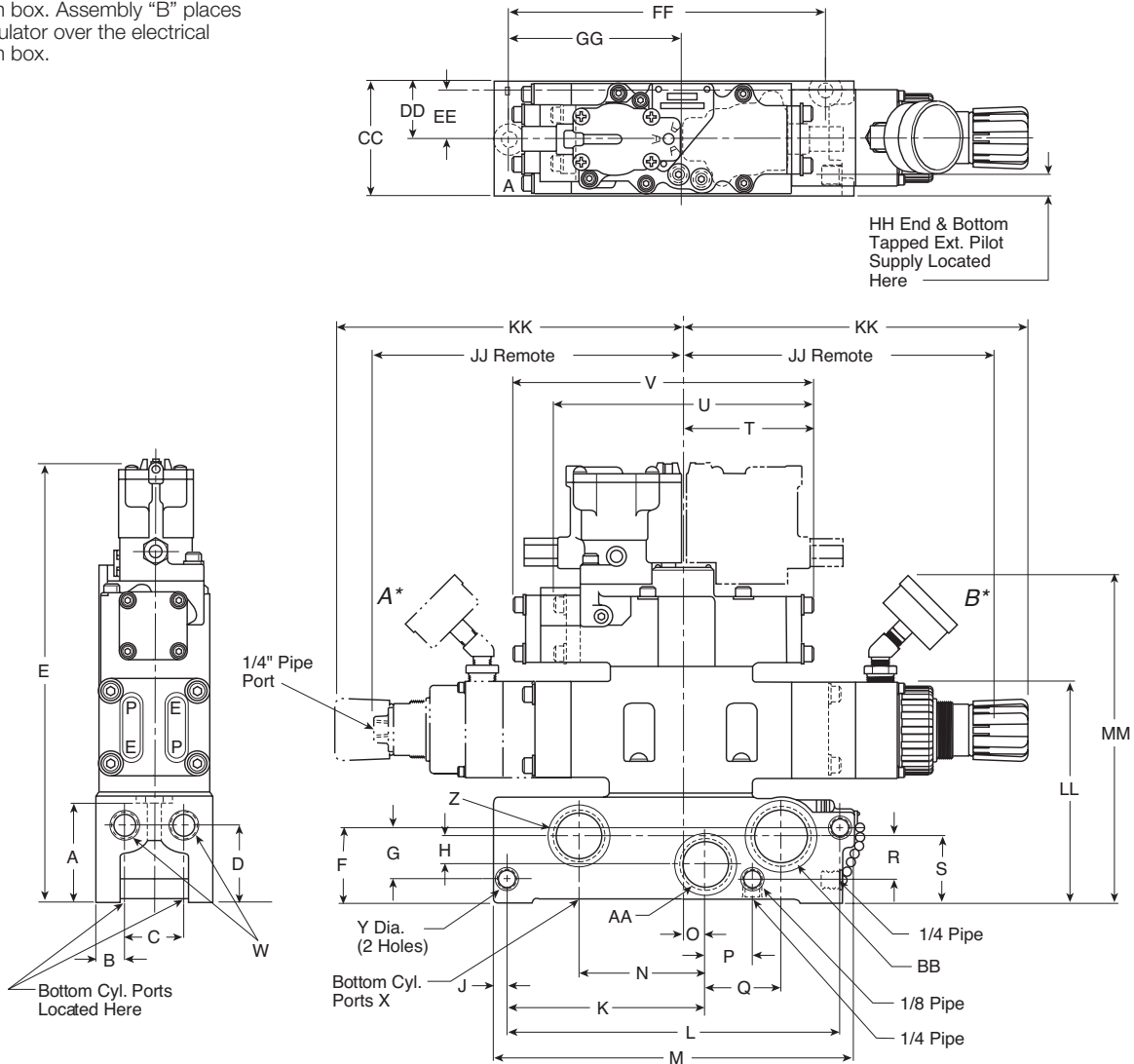

Dimensions - 3/8" Basic Valve

A	B	C	D	E	F	G	H	J	K	L	M	N	O
2.56 (65.0)	.75 (19.1)	1.50 (38.1)	2.09 (53.1)	11.28 (286.5)	2.06 (52.3)	1.41 (35.8)	.75 (19.1)	.34 (8.64)	5.00 (127.0)	8.44 (214.4)	9.09 (230.9)	3.19 (81.0)	.61 (15.5)
P	Q	R	S	T	U	V	W	X	Y	Z	AA	BB	CC
1.19 (30.2)	1.91 (48.5)	1.09 (27.7)	1.81 (46.0)	3.32 (84.3)	6.64 (168.7)	7.56 (192.0)	3/8", 1/2" or 3/4" NPTF	.39 (9.9)	1" NPTF	1" NPTF	1-1/4" NPTF	3.00 (76.2)	
DD	EE	FF	GG	HH	JJ	KK	LL	MM					
1.50 (38.1)	1.24 (31.5)	7.97 (202.4)	4.34 (110.2)	.40 (10.2)	8.53 (216.6)	10.15 (257.8)	5.46 (138.6)	8.80 (223.5)					

Inches (mm)



For inventory, lead times, and kit lookup, visit www.pdnplu.com

D289

Parker Hannifin Corporation
 Pneumatic Division
 Richland, Michigan
www.parker.com/pneumatics

D

Subbase & Manual Valves

H Series Micro

Moduflex Series

H Series ISO

Network Connectivity

DX ISOMAX Series

Valvair II Series

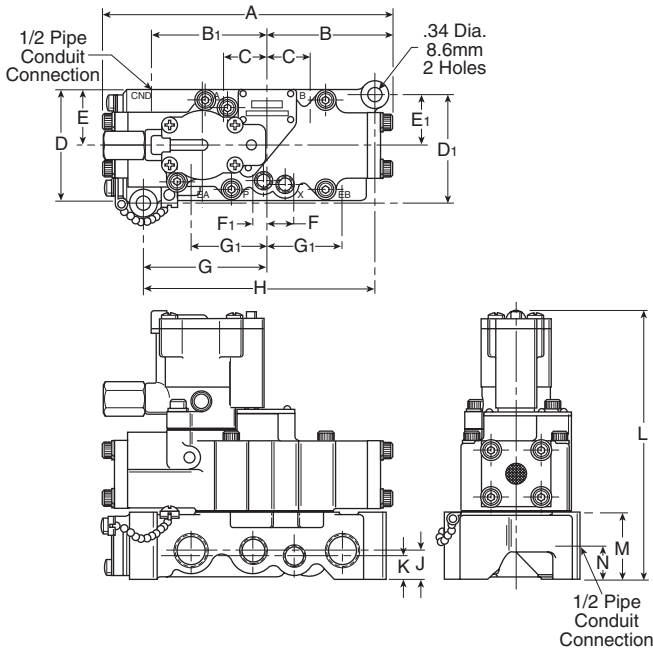

L6753 3/8" Dimensions, Single Solenoid

A	B	B ₁	C	D	D ₁	E	E ₁	F
7.56 (192)	3.32 (84.3)	2.94 (74.7)	1.12 (28.4)	2.88 (73.2)	2.84 (72.1)	1.44 (36.6)	1.34 (34)	.75 (19.1)
F ₁	G	G ₁	H	J	K	L	M	N
.38 (9.7)	3.16 (80.3)	2.00 (50.8)	6.03 (153.2)	.75 (19.1)	.62 (15.7)	6.93 (176)	1.75 (44.5)	1.00 (25.4)

Inches (mm)

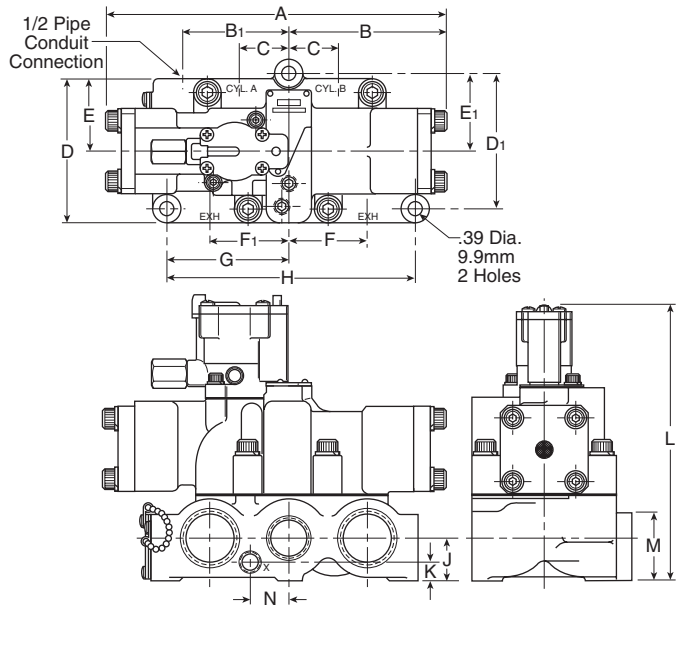

L6758 1" Dimensions, Single Solenoid

A	B	B ₁	C	D	D ₁	E	E ₁	F
10.46 (265.7)	4.75 (120.6)	2.94 (74.7)	3.38 (85.8)	4.56 (115.8)	4.28 (108.7)	2.28 (57.9)	2.44 (62)	2.45 (62.2)
F ₁	G	H	J	K	L	M	N	
2.46 (62.5)	3.81 (96.8)	7.62 (193.5)	1.31 (33.3)	.59 (15)	8.74 (222)	2.09 (53.1)	1.22 (31)	

Inches (mm)

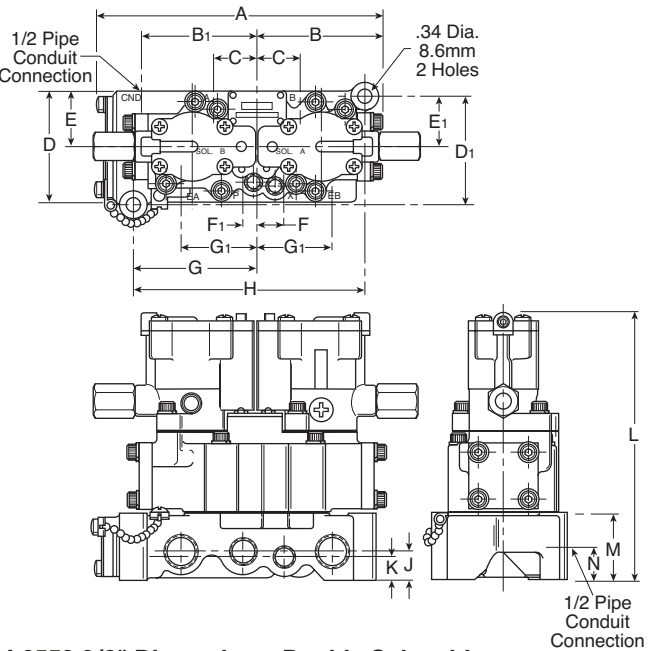

L6553 3/8" Dimensions, Double Solenoid

A	B	B ₁	C	D	D ₁	E	E ₁	F
7.38 (187.5)	3.32 (84.3)	2.94 (74.7)	1.12 (28.4)	2.88 (73.2)	2.84 (72.1)	1.44 (36.6)	1.34 (34)	.75 (19.1)
F ₁	G	G ₁	H	J	K	L	M	N
.38 (9.7)	3.16 (80.3)	2.00 (50.8)	6.03 (153.2)	.75 (19.1)	.62 (15.7)	6.93 (176)	1.75 (44.5)	1.00 (25.4)

Inches (mm)

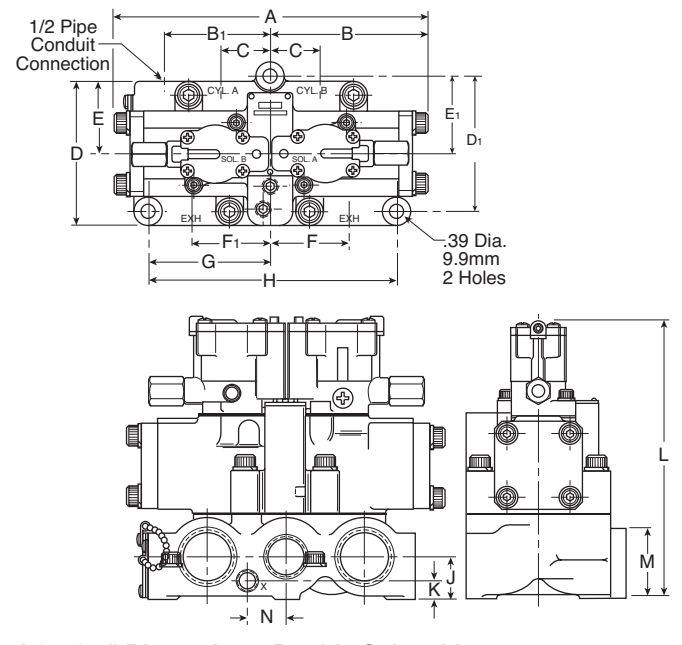

L6558 1" Dimensions, Double Solenoid

A	B	B ₁	C	D	D ₁	E	E ₁	F
9.50 (241.3)	4.75 (120.6)	3.38 (85.8)	1.53 (38.9)	4.56 (115.8)	4.28 (108.7)	2.28 (57.9)	2.44 (62)	2.45 (62.2)
F ₁	G	H	J	K	L	M	N	
2.46 (62.5)	3.81 (96.8)	7.62 (193.5)	1.31 (33.3)	.59 (15)	8.74 (222)	2.09 (53.1)	1.22 (31)	

Inches (mm)

D
 Subbase & Manual Valves
 H Series Micro
 Moduteflex Series
 H Series ISO
 Network Connectivity
 DX ISOMAX Series
 Valvair II Series



For inventory, lead times, and kit lookup, visit www.pdnplu.com

D290

Parker Hannifin Corporation
 Pneumatic Division
 Richland, Michigan
www.parker.com/pneumatics

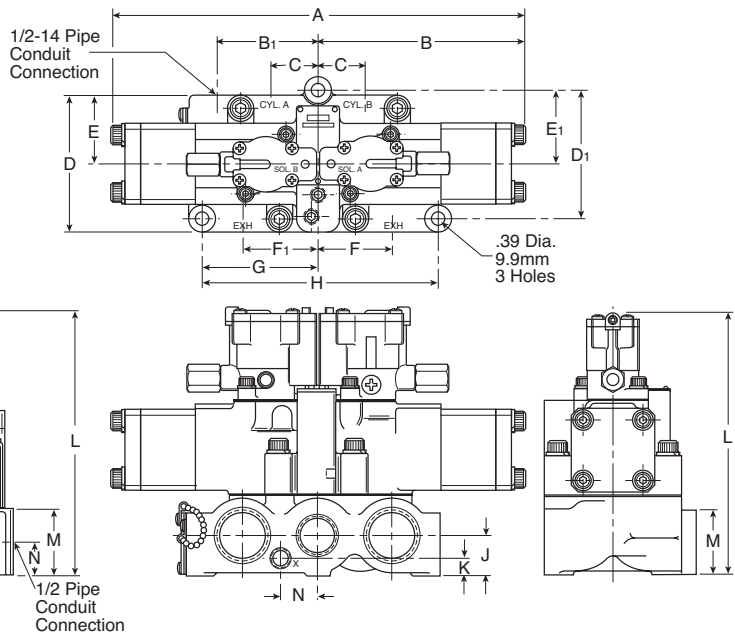
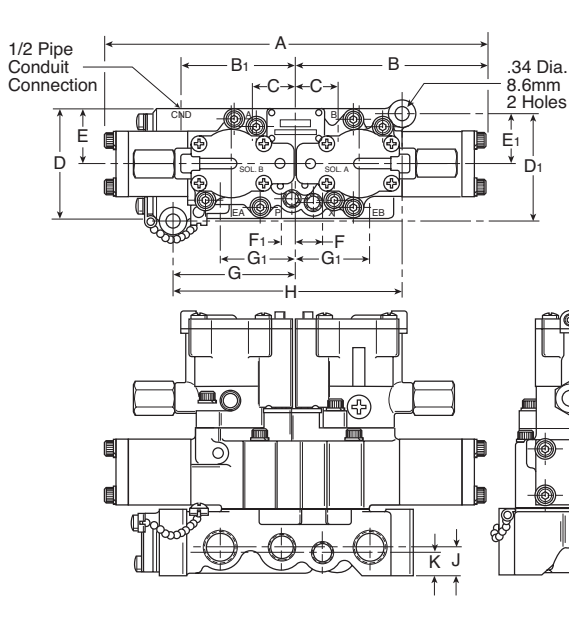

L6653 3/8" Dimensions, 3-Position, Double Solenoid

A	B	B ₁	C	D	D ₁	E	E ₁	F
9.64 (244.8)	4.82 (122.4)	2.94 (74.7)	1.12 (28.4)	2.88 (73.2)	2.84 (72.1)	1.44 (36.6)	1.34 (34)	.75 (19.1)
F ₁	G	G ₁	H	J	K	L	M	
.38 (9.7)	3.16 (80.3)	2.00 (50.8)	6.03 (153.2)	.75 (19.1)	.62 (15.7)	6.93 (176)	1.00 (25.4)	

Inches (mm)

L6658 1" Dimensions, 3-Position, Double Solenoid

A	B	B ₁	C	D	D ₁	E	E ₁	F
13.62 (345.9)	6.81 (173)	3.38 (85.8)	1.53 (38.9)	4.56 (115.8)	4.28 (108.7)	2.28 (57.9)	2.44 (62)	2.45 (62.2)
F ₁	G	H	J	K	L	M	N	
2.46 (62.5)	3.81 (96.8)	7.62 (193.5)	1.31 (33.3)	.59 (15)	8.74 (222)	2.09 (53.1)	1.22 (31)	

Inches (mm)

D
Subbase & Manual Valves

H Series Micro

Modulflex Series

H Series ISO

Network Connectivity

DX ISOMAX Series

Valvair II Series

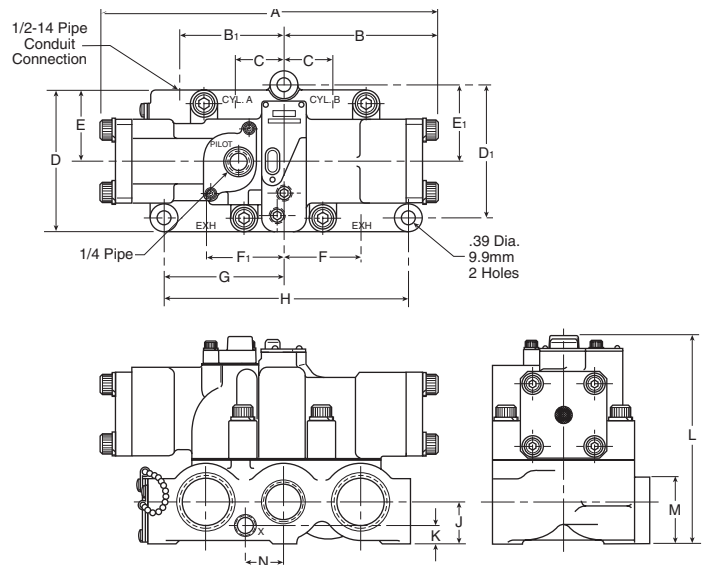
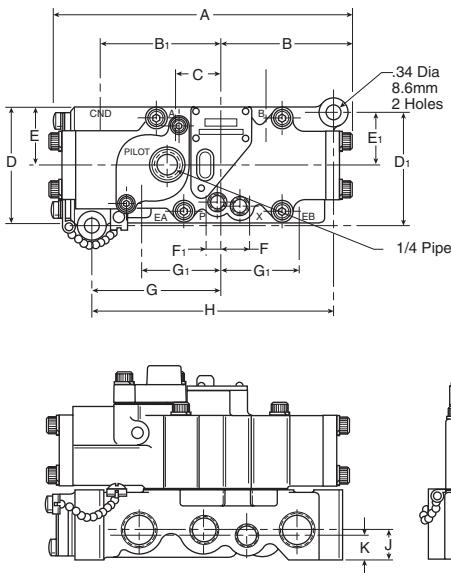

L6743 3/8" Dimensions, Single Remote Pilot

A	B	B ₁	C	D	D ₁	E	E ₁	F
7.56 (192)	3.32 (84.3)	2.94 (74.7)	1.12 (28.4)	2.88 (73.2)	2.84 (72.1)	1.44 (36.6)	1.34 (34)	.75 (19.1)
F ₁	G	G ₁	H	J	K	L	M	
.38 (9.7)	3.16 (80.3)	2.00 (50.8)	6.03 (153.2)	.75 (19.1)	.62 (15.7)	4.76 (120.9)	1.75 (44.5)	

Inches (mm)

L6748 1" Dimensions, Single Remote Pilot

A	B	B ₁	C	D	D ₁	E	E ₁	F
10.46 (265.7)	4.75 (120.6)	3.38 (85.8)	1.53 (38.9)	4.56 (115.8)	4.28 (108.7)	2.28 (57.9)	2.44 (62)	2.45 (62.2)
F ₁	G	H	J	K	L	M	N	
2.46 (62.5)	3.81 (96.8)	7.62 (193.5)	1.31 (33.3)	.59 (15)	6.57 (166.9)	2.09 (53.1)	1.22 (31)	

Inches (mm)



For inventory, lead times, and kit lookup, visit www.pdnplu.com

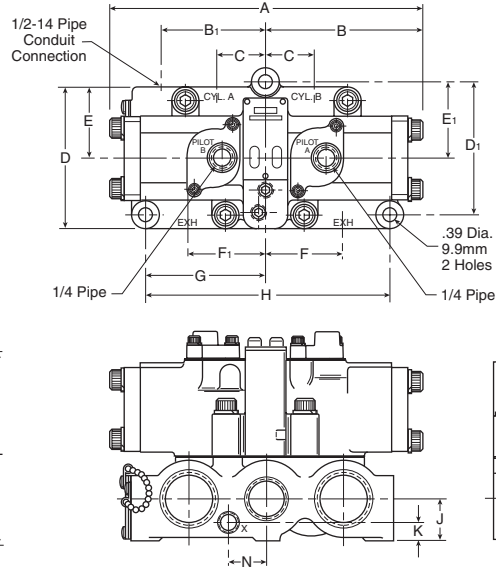
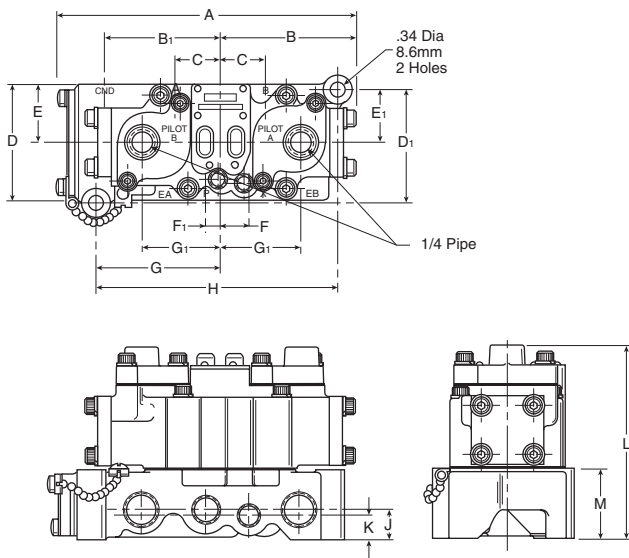

L6543 3/8" Dimensions, Double Remote Pilot

A	B	B ₁	C	D	D ₁	E	E ₁	F
7.56 (192)	3.32 (84.3)	2.94 (74.7)	1.12 (28.4)	2.88 (73.2)	2.84 (72.1)	1.44 (36.6)	1.34 (34)	.75 (19.1)
F ₁	G	G ₁	H	J	K	L	M	
.38 (9.7)	3.16 (80.3)	2.00 (50.8)	6.03 (153.2)	.75 (19.1)	.62 (15.7)	4.76 (120.9)	1.75 (44.5)	

Inches (mm)

L6548 1" Dimensions, Double Remote Pilot

A	B	B ₁	C	D	D ₁	E	E ₁	F
9.50 (241.3)	4.75 (120.6)	3.38 (85.8)	1.53 (38.9)	4.56 (115.8)	4.28 (108.7)	2.28 (57.9)	2.44 (62)	2.45 (62.2)
F ₁	G	H	J	K	L	M	N	
2.46 (62.5)	3.81 (96.8)	7.62 (193.5)	1.31 (33.3)	.59 (15)	6.57 (166.9)	2.09 (53.1)	1.22 (31)	

Inches (mm)

D
Subbase & Manual Valves
H Series Micro
Modulflex Series
H Series ISO
Network Connectivity
DX ISOMAX Series
Valvair II Series

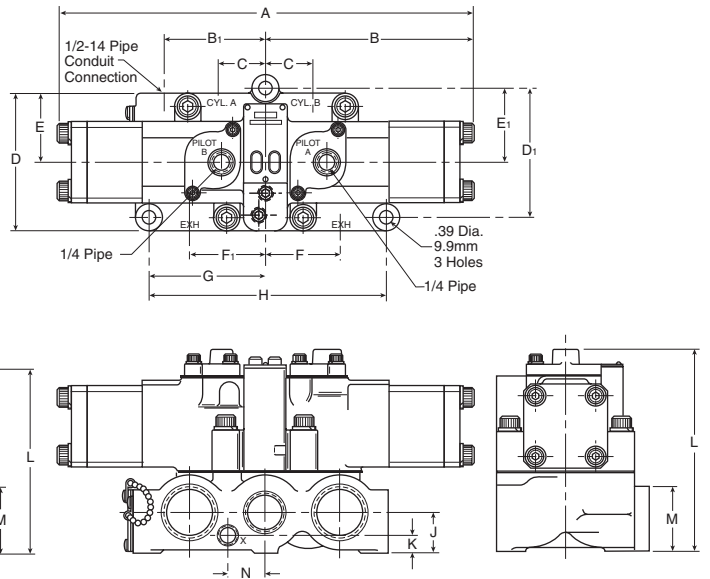
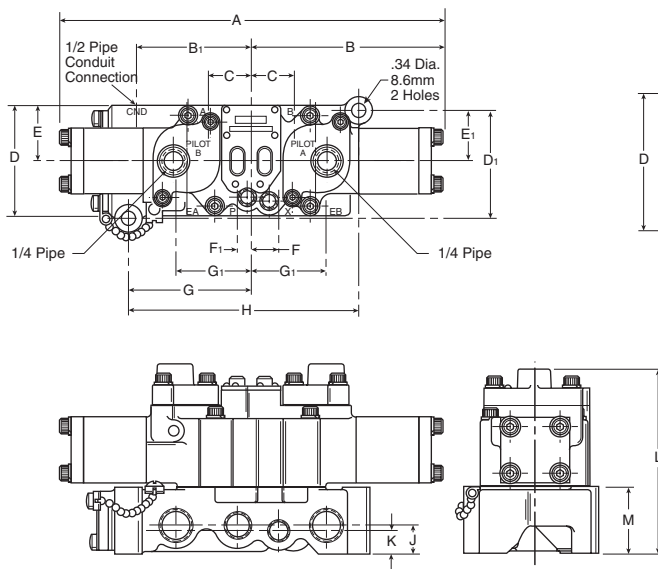

L6643 3/8" Dimensions, 3-Position, Remote Pilot

A	B	B ₁	C	D	D ₁	E	E ₁	F
9.64 (244.8)	4.82 (122.4)	2.94 (74.7)	1.12 (28.4)	2.88 (73.2)	2.84 (72.1)	1.44 (36.6)	1.34 (34)	.75 (19.1)
F ₁	G	G ₁	H	J	K	L	M	
.38 (9.7)	3.16 (80.3)	2.00 (50.8)	6.03 (153.2)	.75 (19.1)	.62 (15.7)	4.76 (120.9)	1.75 (44.5)	

Inches (mm)

L6648 1" Dimensions, 3-Position, Remote Pilot

A	B	B ₁	C	D	D ₁	E	E ₁	F
13.62 (345.9)	6.81 (173)	3.38 (85.8)	1.53 (38.9)	4.56 (115.8)	4.28 (108.7)	2.28 (57.9)	2.44 (62)	2.45 (62.2)
F ₁	G	H	J	K	L	M	N	
2.46 (62.5)	3.81 (96.8)	7.62 (193.5)	1.31 (33.3)	.59 (15)	6.57 (166.8)	2.09 (53.1)	1.22 (31)	

Inches (mm)



For inventory, lead times, and kit lookup, visit www.pdnplu.com

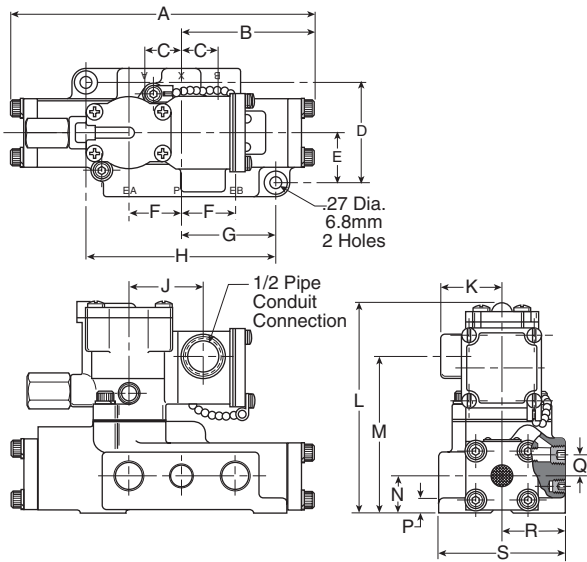

L705 3/8" Dimensions, Single Solenoid

A	B	C	D	E	F	G	H	J
7.56	3.32	.90	2.56	1.28	1.33	2.34	4.69	1.82
(192)	(84.3)	(22.9)	(65)	(32.5)	(33.8)	(59.4)	(119.1)	(46.2)
K	L	M	N	P	Q	R	S	
1.50	5.35	3.91	.94	.38	.53	1.62	3.25	
(38.1)	(135.9)	(99.3)	(23.9)	(9.7)	(13.5)	(41.1)	(82.6)	

Inches (mm)

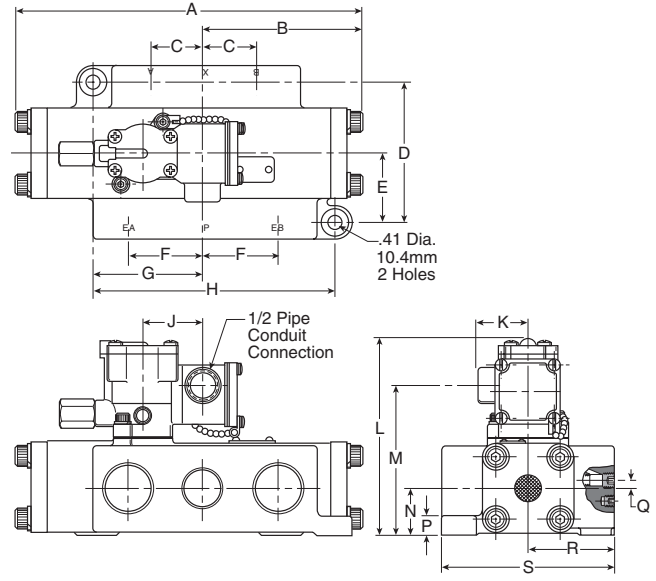

L705 1" Dimensions, Single Solenoid

A	B	C	D	E	F	G	H	J
10.46	4.75	1.62	4.25	2.12	2.19	3.44	7.44	1.82
(265.7)	(120.6)	(41.1)	(108)	(53.8)	(55.6)	(87.4)	(189)	(46.2)
K	L	M	N	P	Q	R	S	
1.50	6.44	4.95	1.50	.69	.20	2.62	5.25	
(38.1)	(163.6)	(125.7)	(38.1)	(17.5)	(5.1)	(66.5)	(133.4)	

Inches (mm)

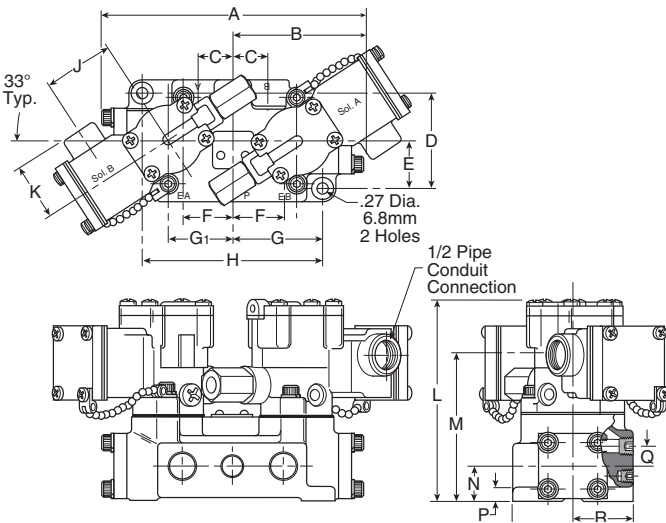

L685 3/8" Dimensions, Double Solenoid

A	B	C	D	E	F	G	G ₁	H
7.56	3.32	.90	2.56	1.28	1.33	2.34	1.66	4.69
(192)	(84.3)	(22.9)	(65)	(32.5)	(33.8)	(59.4)	(42.4)	(119.1)
J	K	L	M	N	P	Q	R	S
1.82	1.50	5.35	3.91	.94	.38	.53	1.62	3.25
(46.2)	(38.1)	(135.9)	(99.3)	(23.9)	(9.7)	(13.5)	(41.1)	(82.6)

Inches (mm)

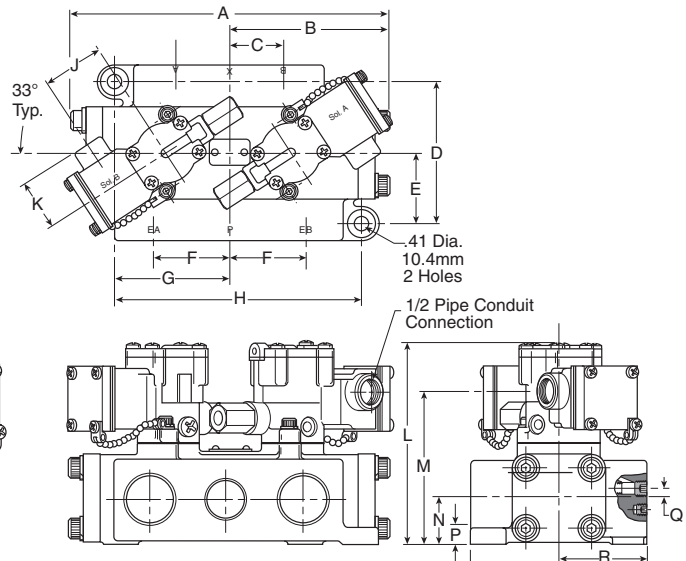

L685 1" Dimensions, Double Solenoid

A	B	C	D	E	F	G	H	J
9.50	4.75	1.62	4.25	2.12	2.19	3.44	7.44	1.82
(241.3)	(120.6)	(41.1)	(108)	(53.8)	(55.6)	(87.4)	(189)	(46.2)
K	L	M	N	P	Q	R	S	
1.50	6.44	4.95	1.50	.69	.20	2.62	5.25	
(38.1)	(163.6)	(125.7)	(38.1)	(17.5)	(5.1)	(66.5)	(133.4)	

Inches (mm)



For inventory, lead times, and kit lookup, visit www.pdnplu.com

D293

Parker Hannifin Corporation
 Pneumatic Division
 Richland, Michigan
www.parker.com/pneumatics

D

Subbase & Manual Valves

H Series Micro

Modulux Series

H Series ISO

Network Connectivity

DX ISOMAX Series

Valvair II Series

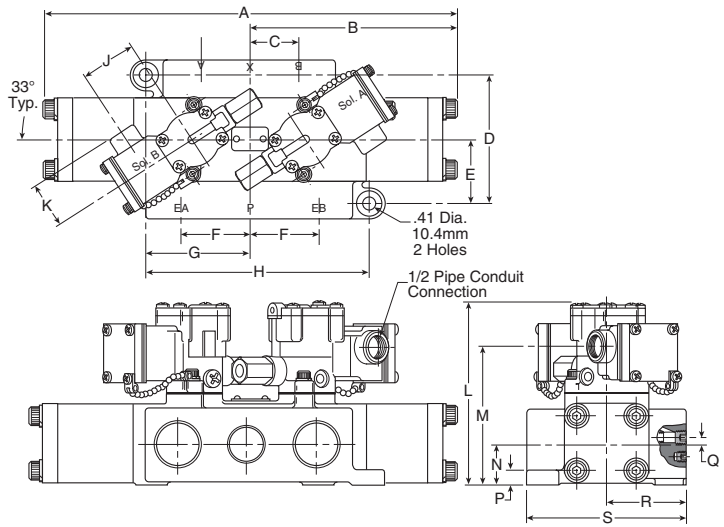
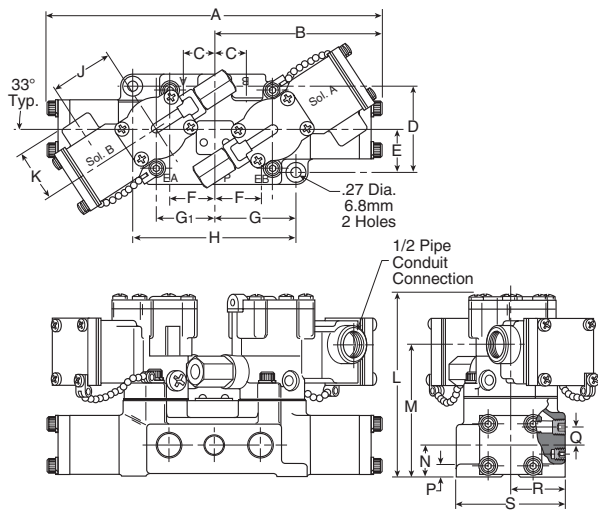

L695 3/8" Dimensions, 3-Position Double Solenoid

A	B	C	D	E	F	G	G ₁	H
9.64	4.82	.90	2.56	1.28	1.33	2.34	1.66	4.69
(244.8)	(122.4)	(22.9)	(65)	(32.5)	(33.8)	(59.4)	(42.4)	(119.1)
J	K	L	M	N	P	Q	R	S
1.82	1.50	5.35	3.91	.94	.38	.53	1.62	3.25
(46.2)	(38.1)	(135.9)	(99.3)	(23.9)	(9.7)	(13.5)	(41.1)	(82.6)

Inches (mm)

L695 1" Dimensions, 3-Position, Double Solenoid

A	B	C	D	E	F	G	H	J
13.63	6.81	1.62	4.25	2.12	2.19	3.44	7.44	1.82
(346.2)	(173)	(41.1)	(108)	(53.8)	(55.6)	(87.4)	(189)	(46.2)
K	L	M	N	P	Q	R	S	
1.50	6.44	4.95	1.50	.69	.20	2.62	5.25	
(38.1)	(163.6)	(125.7)	(38.1)	(17.5)	(5.1)	(66.5)	(133.4)	

Inches (mm)

D
Subbase & Manual Valves
H Series Micro
Modulflex Series
H Series ISO
Network Connectivity
DX ISOMAX Series
Valvair II Series

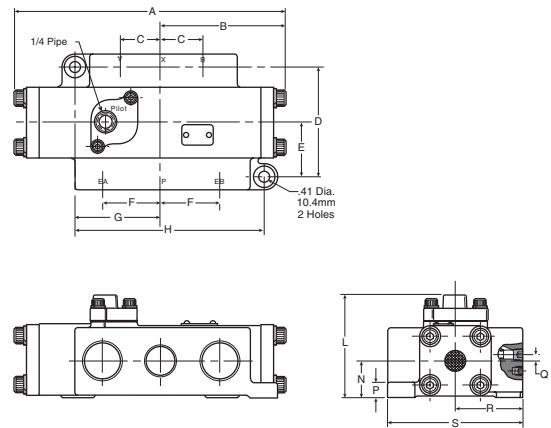
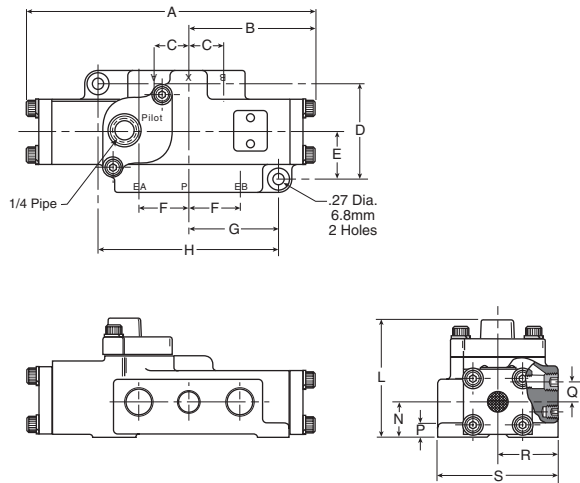

L704 3/8" Dimensions, Single Remote Pilot

A	B	C	D	E	F	G	H	L
7.56	3.32	.90	2.56	1.28	1.33	2.34	4.69	3.18
(192)	(84.3)	(22.9)	(65)	(32.5)	(33.8)	(59.4)	(119.1)	(80.8)
N	P	Q	R	S				
.94	.38	.53	1.62	3.25				
(23.9)	(9.7)	(13.5)	(41.1)	(82.6)				

Inches (mm)

L704 1" Dimensions, Single Remote Pilot

A	B	C	D	E	F	G	H	L
10.46	4.75	1.62	4.25	2.12	2.19	3.44	7.44	4.09
(265.7)	(120.6)	(41.1)	(108)	(53.8)	(55.6)	(87.4)	(189)	(103.9)
N	P	Q	R	S				
1.50	.69	.20	2.62	5.25				
(38.1)	(17.5)	(5.1)	(66.5)	(133.4)				

Inches (mm)



For inventory, lead times, and kit lookup, visit www.pdnplu.com

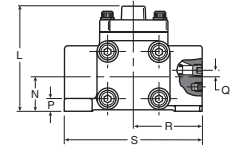
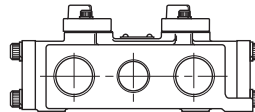
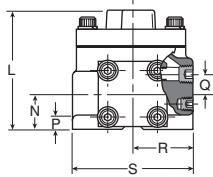
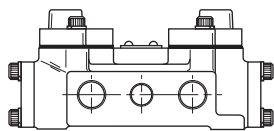
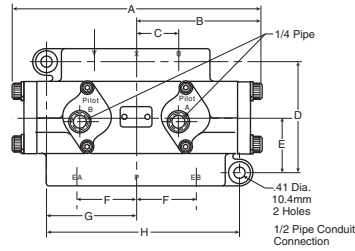
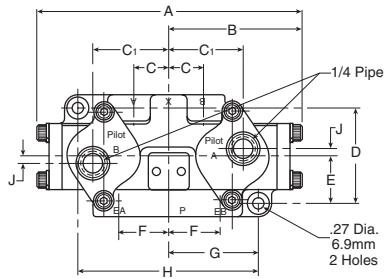

L684 3/8" Dimensions, Double Remote Pilot

A	B	C	C ₁	D	E	F	G	H
6.64	3.32	.90	1.98	2.56	1.28	1.33	2.34	4.69
(168.7)	(84.3)	(22.9)	(50.3)	(65)	(32.5)	(33.8)	(59.4)	(119.1)
J	L	N	P	Q	R	S		
.22	3.05	.94	.38	.53	1.62	3.25		
(5.6)	(77.5)	(23.9)	(9.7)	(13.5)	(41.1)	(82.6)		

Inches (mm)

L684 1" Dimensions, Double Remote Pilot

A	B	C	D	E	F	G	H	L
9.50	4.75	1.62	4.25	2.12	2.19	3.44	7.44	4.09
(241.3)	(120.6)	(41.1)	(108)	(53.8)	(55.6)	(87.4)	(189)	(103.9)
N	P	Q	R	S				
1.50	.69	.20	2.62	5.25				
(38.1)	(17.5)	(5.1)	(66.5)	(133.4)				

Inches (mm)

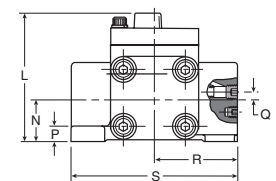
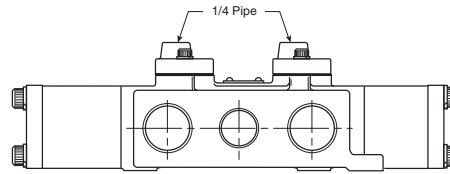
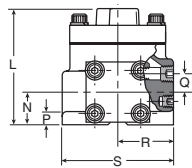
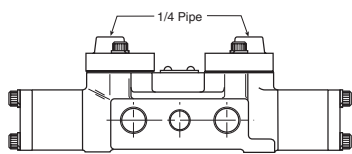
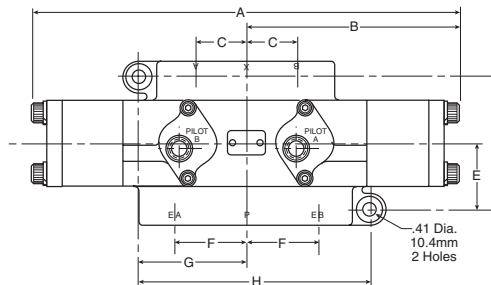
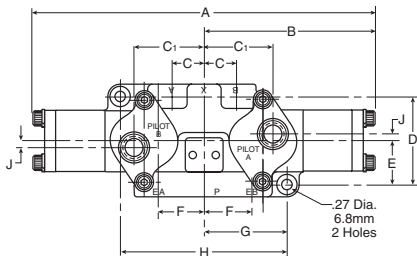

L694 3/8" Dimensions, 3-Position, Double Remote Pilot

A	B	C	C ₁	D	E	F	G	H
9.64	4.82	.90	1.98	2.56	1.28	1.33	2.34	4.69
(244.8)	(122.4)	(22.9)	(50.3)	(65)	(32.5)	(33.8)	(59.4)	(119.1)
J	L	N	P	Q	R	S		
.22	3.05	.94	.38	.53	1.62	3.25		
(5.6)	(77.5)	(23.9)	(9.7)	(13.5)	(41.1)	(82.6)		

Inches (mm)

L694 1" Dimensions, 3-Position, Double Remote Pilot

A	B	C	D	E	F	G	H	L
13.63	6.81	1.62	4.25	2.12	2.19	3.44	7.44	6.44
(346.2)	(173)	(41.1)	(108)	(53.8)	(55.6)	(87.4)	(189)	(163.6)
N	P	Q	R	S				
1.50	.69	.20	2.62	5.25				
(38.1)	(17.5)	(5.1)	(66.5)	(133.4)				

Inches (mm)



For inventory, lead times, and kit lookup, visit www.pdnplu.com

D295

Parker Hannifin Corporation
 Pneumatic Division
 Richland, Michigan
www.parker.com/pneumatics

D

Subbase & Manual Valves

H Series Micro

Modulflex Series

H Series ISO

Network Connectivity

DX ISOMAX Series

Valvair II Series

Plug-in Manifold, 3/8" Basic

- K142230Cylinder ports 3/8" NPTF
- K142231Cylinder ports 1/2" NPTF
- K142270Cylinder ports 3/4" NPTF
- Exhaust port..... 1" NPTF
- Inlet port..... 1" NPTF
- Conduit port..... 1-1/4" NPTF

Note: Manifold assemblies include mounting hardware.

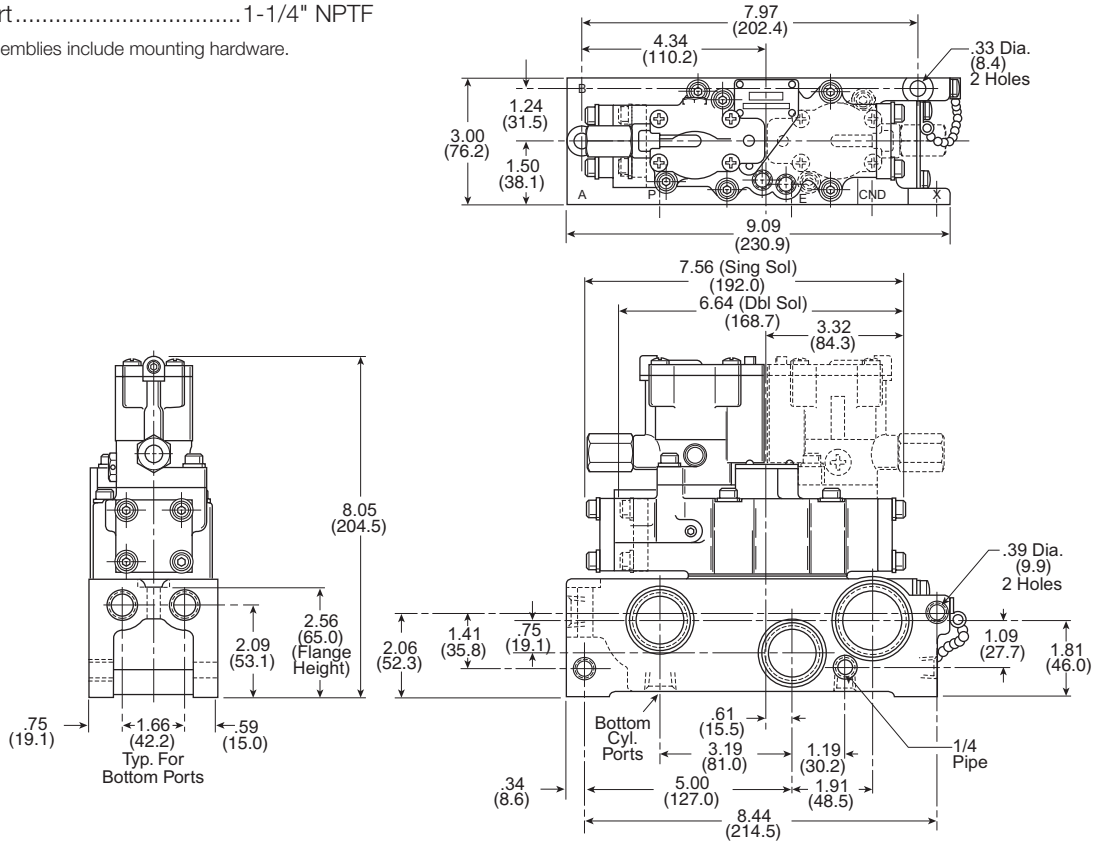

D	Subbase & Manual Valves
H Series Micro	Modulflex Series
H Series ISO	Network Connectivity
DX ISOMAX Series	Valvair II Series



For inventory, lead times, and kit lookup, visit www.pdnplu.com

D296

Parker Hannifin Corporation
 Pneumatic Division
 Richland, Michigan
www.parker.com/pneumatics