

35 flow ranges in 6 tube sizes with full horizontal and vertical connection options make these flowmeters the most versatile removable glass tube meters available. The powder-coated 304 stainless steel case and precision molded polycarbonate shield will tolerate most corrosive applications.

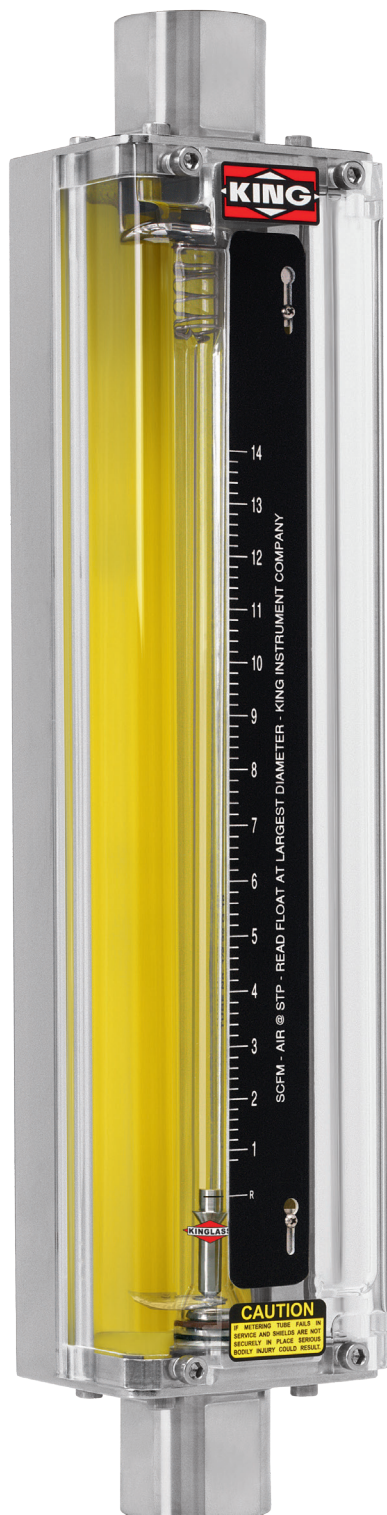

DESCRIPTION

Metering Tube	Borosilicate Kinglass
Internal Components	Standard: 316L SS Optional: Hastelloy®C-276
Fitting Material	Standard: 316L SS Optional: PVDF (FNPT Only)
Inlet/Outlet Fittings	FNPT or flange, vertical or horizontal
O-Ring	Standard: Viton® Optional: Buna N, EPR, and Kalrez®
Case	Powder-coated 304 SS
Cover	Molded polycarbonate shield

PERFORMANCE

Capacities	Water	0.23 to 85 GPM
	Air	1.15 to 285 SCFM
Scale	Size 3 to 6	250 mm (10")
	Size 8 to 9	200 mm (8")
		direct reading, detachable scales
Accuracy		± 2% of full scale flow
Turndown		10:1
Repeatability		0.5%
Maximum Temperature	316L SS fittings	200° F (93° C)
	PVDF fittings	200° F (93° C)
Maximum Pressure	316L SS fittings	300 psig, size 3 & 4
	316L SS fittings	250 psig, size 5 & 6
	316L SS fittings	75 psig, size 8 & 9
	PVDF fittings	150 psig, size 3 & 4
	PVDF fittings	150 psig, size 5 & 6
	PVDF fittings	75 psig, size 8 & 9
Ambient Temperature		33° F to 125° F (1° C to 52° C)

OPTIONS

Alarm	Latching Reed Switch (See page 64)
Valve	External valve - 316L SS (size 3 to size 6 FNPT only)
Certified Calibrations	Conform to ISA RP 16.6
Scales	Any volumetric unit.

FLOATS

Options for rotameter float materials and designs extend flow ranges for different fluids within a given rotameter tube design.

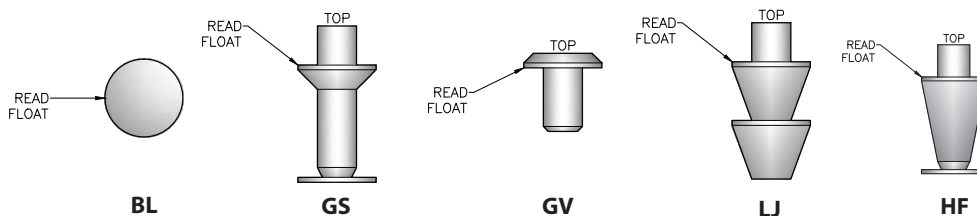

DIMENSION DIAGRAMS

**Vertical FNPT
Front View**

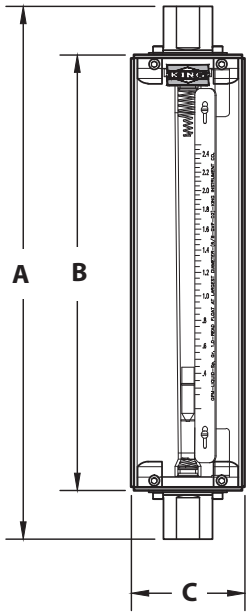

**Vertical FNPT
Back View (mounting)**

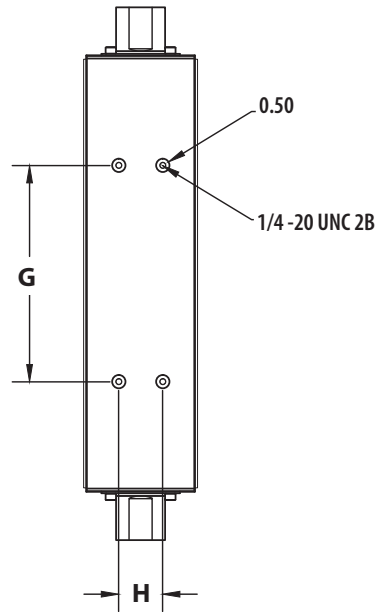

**Horizontal FNPT
Side View**

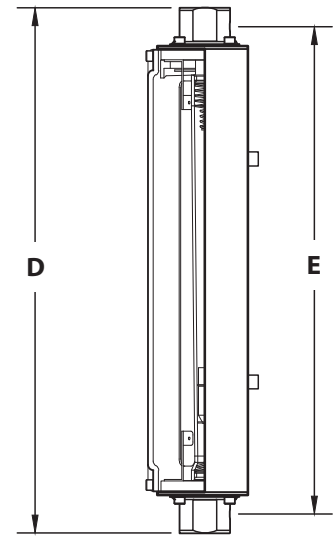

**Vertical Flange
Side View**

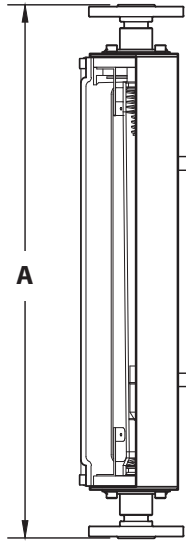

**Horizontal Flange
Side View**

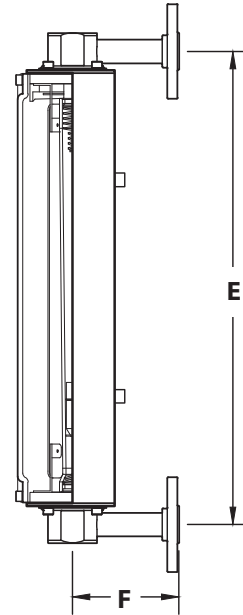

**Alarm
Connection**

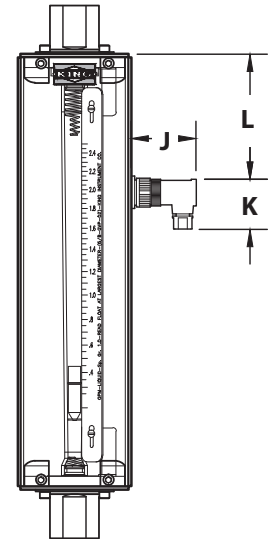

Water Order Number	Air Order Number	Case And Fittings (inches)					Mounting		Alarm Connection			Connection Size		
		A	B	C	D	E	F	G	H	J	K	L	FNPT	Flange
31W - 47W	31A - 47A	19.70	16.1	4.13	18.86	17.5	3.94	8.00	1.63	2.5	1.85	4.63	1/2"	1/2"
51W - 67W	51A - 67A	19.70	16.1	4.13	18.86	17.5	4.72	8.00	1.63	2.5	1.85	4.63	3/4"	1"
81W - 95W	81A - 94A	19.78	16.3	5.75	23.26	20.5	5.12	*	*	2.5	1.85	4.83	1 1/2"	1 1/2"

* Mounting studs are not available in size 8 and 9

Order Number	Full Scale Flow GPM - Water	Order Number	Full Scale Flow SCFM - Air	Float Number	Float Type	Alarm Option	Pressure Drop (Inches of Water)
31W	0.23	31A	1.15	3-BLG-01	BL	No	4
32W	0.49	32A	2.10	3-BLG02	BL	No	4
33W	.64	33A	2.64	3-HFG-01	HF	Yes	4
34W	.77	34A	3.20	3-LJG-01	LJ	Yes	4
41W	1.1	41A	4.20	4-GVG-01	GV	Yes	6
42W	1.3	42A	5.50	4-GSG-01	GS	Yes	6
43W	1.5	43A	6.20	4-GVG-02	GV	Yes	8
44W	1.8	44A	7.60	4-GSG-02	GS	Yes	9
45W	2.2	45A	9.00	4-GSG-03	GS	Yes	15
46W	2.5	46A	10.2	4-GSG-03	GS	Yes	19
47W	3.4	47A	14.0	4-GSG-04	GS	Yes	27
51W	2.5	51A	10.0	5-GVG-01	GV	Yes	6
52W	3.0	52A	12.0	5-GSG-01	GS	Yes	6
53W	3.5	53A	14.4	5-GSG-02	GS	Yes	10
54W	4.0	54A	16.4	5-GVG-02	GV	Yes	15
55W	5.0	55A	20.0	5-LJG-01	LJ	Yes	41
61W	6.5	61A	26.8	6-GSG-01	GS	Yes	13
62W	7.0	62A	28.8	6-GVG-01	GV	Yes	20
63W	8.2	63A	34.0	6-GSG-02	GS	Yes	27
64W	10.5	64A	44.0	6-GVG-02	GV	Yes	30
65W	13.0	65A	54.0	6-GSG-03	GS	Yes	32
66W	16.0	66A	66.0	6-GVG-03	GV	Yes	48
67W	20.0	67A	82.0	6-HFG-01	HF	Yes	97
81W	15.0	81A	61.0	8-GVG-01	GV	Yes	8
82W	20.0	82A	82.0	8-GVG-02	GV	Yes	13
83W	25.0	83A	103.0	8-GVG-03	GV	Yes	22
84W	28.0	84A	122.0	8-GSG-01	GS	Yes	30
85W	32.0	85A	145.0	8-GSG-02	GS	Yes	24
86W	36.0	86A	155.0	8-HFG-01	HF	Yes	43
91W	41.0	91A	165.0	9-GVG-01	GV	Yes	28
92W	50.0	92A	195.0	9-GVG-02	GV	Yes	44
93W	60.0	93A	245.0	9-GSG-01	GS	Yes	36
94W	70.0	94A	285.0	9-HFG-01	HF	Yes	62
95W	85.0	---	---	9-LJG-01	LJ	Yes	88

* Mounting studs are not available in size 8 and 9

ORDERING:

Use the following guide to determine the specific product number you require.

9 0 0					
Meter Series	Fitting Type/Material	Float Material	O-Ring Material	Order Number	Optional Alarm
	Vertical FNPT - 316L SS - 1	316L SS - 2	EPR - 1	See Specification	No Alarm - 0
	Horizontal FNPT - 316L SS - 2	Hastelloy® C-276 - 4	Buna-N - 2	above	With Alarm - 1
	Vertical Flange -316L SS - 150# - 3	Glass - 5 (For 31A & 31W only)	Viton® - 3		Dual Alarm - 2
	Horizontal Flange -316L SS- 150# - 4		Kalrez® - 4		See Specification table for availability
	Vertical Flange -316L SS - 300# - 5				
	Horizontal Flange -316L SS - 300# - 6				
	Vertical FNPT - PVDF - 7				
	Horizontal FNPT - PVDF - 8				