

OPERATION AND MAINTENANCE  
INSTRUCTION / MANUAL

# Intelligent Pressure Transmitter With Control Capability

**HART**  
COMMUNICATION PROTOCOL

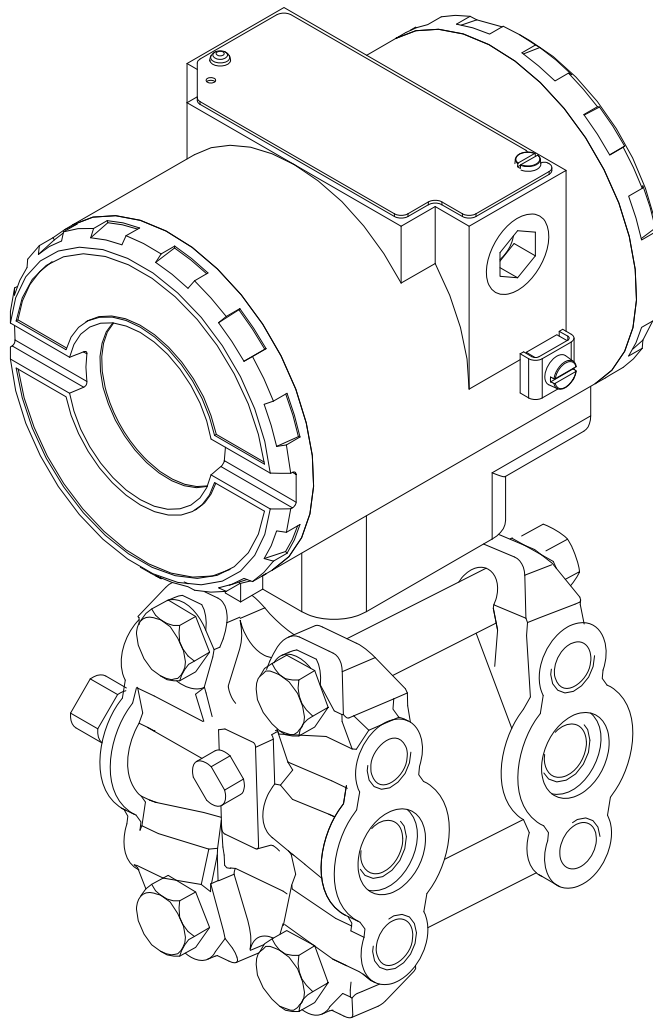

smar - LD301

SEP / 12  
LD301  
VERSION 6





Specifications and information are subject to change without notice.  
Up-to-date address information is available on our website.

web: [www.smar.com/contactus.asp](http://www.smar.com/contactus.asp)

---

# INTRODUCTION

**LD301** is a smart pressure transmitter for differential, absolute, gauge, level and flow measurements. It is based on a field-proven capacitive sensor that provides reliable operation and high performance. The digital technology used in **LD301** enables the choice of several types of transfer functions, an easy interface between the field and the control room and several interesting features that considerably reduce installation, operation and maintenance costs.

Besides all the functions offered by other smart transmitters, **LD301** offers the following functions:

- ✓  $\sqrt{(\Delta P)^3}$  - used for trapezoidal weirs in open channel flow measurement.
- ✓  $\sqrt{(\Delta P)^5}$  - used for V-notch weirs in open channel flow measurement.
- ✓ **TABLE** - the pressure signal is linearly customized according to a 16-point table, enabling, e.g., level-to-volume conversion of a horizontal cylindrical tank.
- ✓ **CONTROLLER** - the Process Variable is compared to a set point. The deviation acts on the output signal according to an optional PID algorithm.
- ✓ **PID OUTPUT CHARACTERIZATION** - the PID output signal (MV) follows a curve that is determined by 16 points, which can be freely configured
- ✓ **BIDIRECTIONAL FLOW FUNCTION** - used to measure the flow in the piping in both directions.
- ✓ **LOCAL ADJUSTMENT** - not Only for Lower and Upper value, but input/output function, operation mode, indication, set point, PID parameters (optional) as well.
- ✓ **PASSWORD** - three levels for different functions.
- ✓ **OPERATION COUNTER** - shows the number of changes in each function.
- ✓ **TOTALIZATION** - flow totalization in volume or mass.
- ✓ **USER-UNIT** - indication in engineering unit of the property actually measured, e.g., level, flow or volume.
- ✓ **WRITE-PROTECT** - via hardware

**Get the best results of the LD301 by carefully reading these instructions.**

**Smart pressure transmitters are protected by U.S. patents 6,433,791 and 6,621,443.**

**NOTE**

This manual is compatible with version 6.XX, where 6 notes software version and XX software release. The indication 6.XX means that this manual is compatible with any release of version 6 software

**WARNING**

To ensure that our products are safe and without risk to health, the manual must be read carefully before proceeding and warning labels on packages must be observed. Installation, operation, maintenance and servicing must only be carried out by suitably trained personnel and in accordance with the **Operation and Maintenance Instruction Manual**.

**Waiver of responsibility**

The contents of this manual abides by the hardware and software used on the current equipment version. Eventually there may occur divergencies between this manual and the equipment. The information from this document are periodically reviewed and the necessary or identified corrections will be included in the following editions. Suggestions for their improvement are welcome.

**Warning**

For more objectivity and clarity, this manual does not contain all the detailed information on the product and, in addition, it does not cover every possible mounting, operation or maintenance cases.

Before installing and utilizing the equipment, check if the model of the acquired equipment complies with the technical requirements for the application. This checking is the user's responsibility.

If the user needs more information, or on the event of specific problems not specified or treated in this manual, the information should be sought from Smar. Furthermore, the user recognizes that the contents of this manual by no means modify past or present agreements, confirmation or judicial relationship, in whole or in part.

All of Smar's obligation result from the purchasing agreement signed between the parties, which includes the complete and sole valid warranty term. Contractual clauses related to the warranty are not limited nor extended by virtue of the technical information contained in this manual.

Only qualified personnel are allowed to participate in the activities of mounting, electrical connection, startup and maintenance of the equipment. Qualified personnel are understood to be the persons familiar with the mounting, electrical connection, startup and operation of the equipment or other similar apparatus that are technically fit for their work. Smar provides specific training to instruct and qualify such professionals. However, each country must comply with the local safety procedures, legal provisions and regulations for the mounting and operation of electrical installations, as well as with the laws and regulations on classified areas, such as intrinsic safety, explosion proof, increased safety and instrumented safety systems, among others.

The user is responsible for the incorrect or inadequate handling of equipments run with pneumatic or hydraulic pressure or, still, subject to corrosive, aggressive or combustible products, since their utilization may cause severe bodily harm and/or material damages.

The field equipment referred to in this manual, when acquired for classified or hazardous areas, has its certification void when having its parts replaced or interchanged without functional and approval tests by Smar or any of Smar authorized dealers, which are the competent companies for certifying that the equipment in its entirety meets the applicable standards and regulations. The same is true when converting the equipment of a communication protocol to another. In this case, it is necessary sending the equipment to Smar or any of its authorized dealer. Moreover, the certificates are different and the user is responsible for their correct use.

Always respect the instructions provided in the Manual. Smar is not responsible for any losses and/or damages resulting from the inadequate use of its equipments. It is the user's responsibility to know and apply the safety practices in his country.

# TABLE OF CONTENTS

<b>SECTION 1 - INSTALLATION</b> .....	<b>1.1</b>
GENERAL.....	1.1
MOUNTING.....	1.1
ELECTRONIC HOUSING.....	1.9
WIRING.....	1.10
LOOP CONNECTIONS.....	1.11
INSTALLATION IN HAZARDOUS AREAS.....	1.13
EXPLOSION/FLAME PROOF.....	1.13
INTRINSICALLY SAFE.....	1.13
<b>SECTION 2 - OPERATION</b> .....	<b>2.1</b>
FUNCTIONAL DESCRIPTION - SENSOR.....	2.1
FUNCTIONAL DESCRIPTION - HARDWARE.....	2.2
FUNCTIONAL DESCRIPTION - SOFTWARE.....	2.3
THE DISPLAY.....	2.6
<b>SECTION 3 - CONFIGURATION</b> .....	<b>3.1</b>
CONFIGURATION FEATURES.....	3.5
MANUFACTURING DATA AND IDENTIFICATION.....	3.5
PRIMARY VARIABLE TRIM - PRESSURE.....	3.6
PRIMARY VARIABLE CURRENT TRIM.....	3.7
TRANSMITTER ADJUSTMENT TO THE WORKING RANGE.....	3.7
ENGINEERING UNIT SELECTION.....	3.8
TRANSFER FUNCTION FOR FLOW MEASUREMENT.....	3.9
TABLE POINTS.....	3.11
TOTALIZATION CONFIGURATION.....	3.11
PID CONTROLLER CONFIGURATION.....	3.12
EQUIPMENT CONFIGURATION.....	3.13
EQUIPMENT MAINTENANCE.....	3.15
<b>SECTION 4 - PROGRAMMING USING LOCAL ADJUSTMENT</b> .....	<b>4.1</b>
THE MAGNETIC TOOL.....	4.1
SIMPLE LOCAL ADJUST.....	4.2
ZERO AND SPAN RERANGING.....	4.3
COMPLETE LOCAL ADJUSTMENT.....	4.3
LOCAL PROGRAMMING TREE.....	4.3
OPERATION [OPER].....	4.4
TUNING [TUNE].....	4.6
CONFIGURATION [CONF].....	4.8
RANGE (RANGE).....	4.9
FUNCTION (FUNCT).....	4.12
OPERATION MODE (MODE).....	4.12
TOTALIZATION [TOTAL].....	4.13
TOTALIZATION BRANCH (TOTAL).....	4.13
PRESSURE TRIM [TRIM].....	4.14
ESCAPE LOCAL ADJUSTMENT [ESC].....	4.15
<b>SECTION 5 - MAINTENANCE</b> .....	<b>5.1</b>
GENERAL.....	5.1
DIAGNOSTIC USING CONFIGURATION TOOL.....	5.1
ERROR MESSAGES.....	5.1
DIAGNOSTIC VIA TRANSMITTER.....	5.2
DISASSEMBLY PROCEDURE.....	5.4
SENSOR.....	5.4
ELECTRONIC CIRCUIT.....	5.4
REASSEMBLY PROCEDURE.....	5.6

SENSOR .....	5.6
ELECTRONIC CIRCUIT .....	5.7
INTERCHANGEABILITY .....	5.8
RETURNING MATERIALS .....	5.8
SMAR INSULATOR KIT .....	5.10
SMAR INSULATOR KIT MOUNTING .....	5.10
APPLICATION WITH HALAR .....	5.14
TECHNICAL SPECIFICATION .....	5.14
PERFORMANCE SPECIFICATION .....	5.14
TPE – TOTAL PROBABLE ERROR (SOFTWARE) .....	5.14
ORDERING CODE FOR THE SENSOR .....	5.15
HART® SPECIAL UNITS .....	5.20
<b>SECTION 6 - TECHNICAL CHARACTERISTICS .....</b>	<b>6.1</b>
ORDERING CODE .....	6.6
OPTIONAL ITEMS .....	6.7
OPTIONAL ITEMS .....	6.9
OPTIONAL ITEMS .....	6.12
<b>APPENDIX A - CERTIFICATIONS INFORMATION .....</b>	<b>A.1</b>
EUROPEAN DIRECTIVE INFORMATION .....	A.1
OTHERS APPROVALS .....	A.1
SANITARY APPROVAL .....	A.1
MARINE APPROVAL .....	A.1
FMEDA REPORT: .....	A.1
HAZARDOUS LOCATIONS CERTIFICATIONS .....	A.1
NORTH AMERICAN CERTIFICATIONS .....	A.1
EUROPEAN CERTIFICATIONS .....	A.2
SOUTH AMERICA CERTIFICATION .....	A.3
ASIA CERTIFICATION .....	A.3
IDENTIFICATION PLATE AND CONTROL DRAWING .....	A.3
IDENTIFICATION PLATE .....	A.3
CONTROL DRAWING .....	A.7
<b>APPENDIX B – SRF – SERVICE REQUEST FORM .....</b>	<b>B.1</b>
<b>APPENDIX C – SMAR WARRANTY CERTIFICATE .....</b>	<b>C.1</b>

# TRANSMITTER GENERAL VIEW

The **LD301** uses a highly proven technique for pressure measuring by capacitance reading. The block diagram of the **LD301** HART® pressure transmitter is shown below.

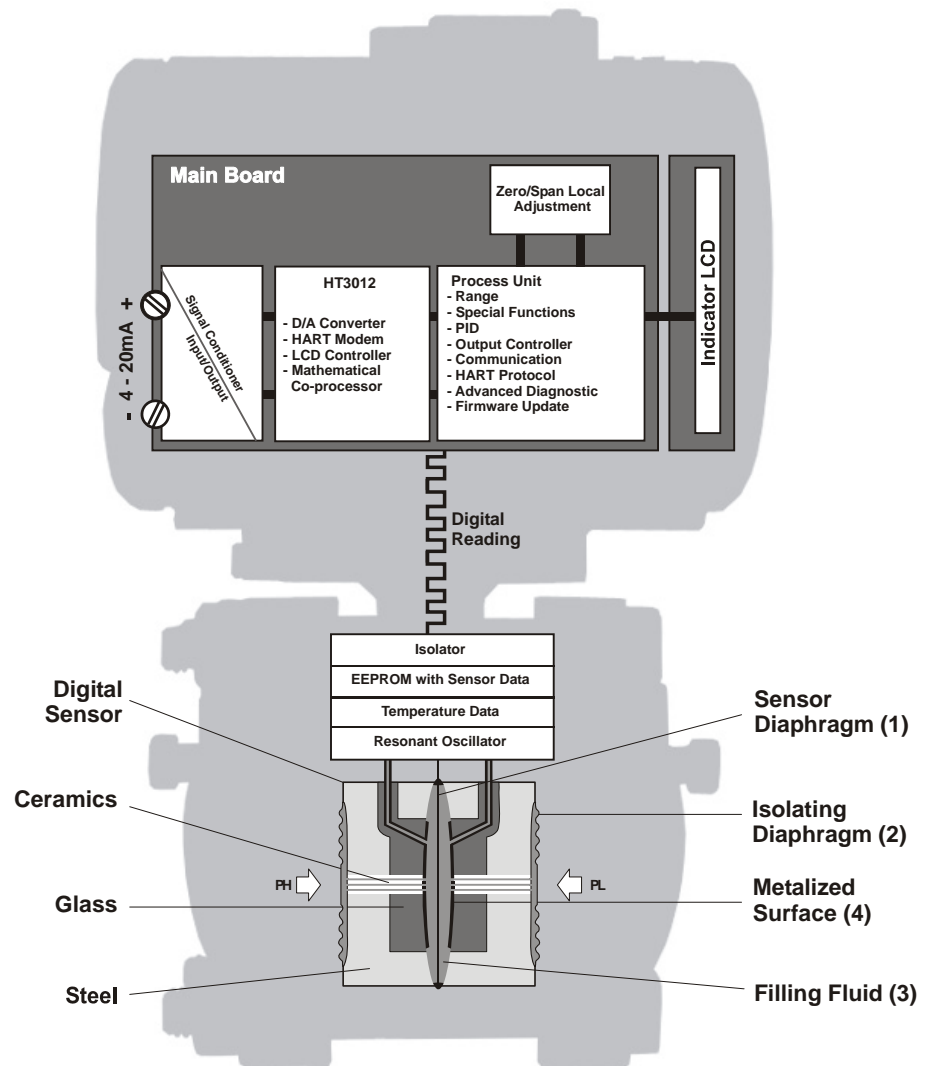

In the cell center is the sensor diaphragm (1). This diaphragm flexes in response to the different pressures applied on the LOW and HIGH sides of the cell (PL and PH). These pressures are directly applied on the isolator diaphragms (2), whose function is to isolate the sensor process and supply high resistance against corrosion caused by process fluids. The pressure is transmitted directly to the sensor diaphragm through the filling fluid (3) and causes its deflection. The sensor diaphragm is a mobile electrode whose two metal surfaces (4) are stable electrodes. A deflection on the sensor diaphragm is read by the capacitance variation between both stable and mobile electrodes.

The resonance oscillator reads the capacitance variations between the mobile and the stable boards and generates a pressure output equivalent to the detected capacitance variation. This pressure value is informed in compliance with the transmitter communication protocol. As the conversion process does not involve an A/D converter, any errors or deviations are eliminated during the process. Temperature compensation is done by a sensor, which combined with a precision sensor, results in high accuracy and range.

The process variable, as well as the diagnostic monitoring and information, are supplied by the digital communication protocol. The **LD301** is available in the HART communication protocol.

Read carefully these instructions for better use of the **LD301**.

# Installation Flowchart

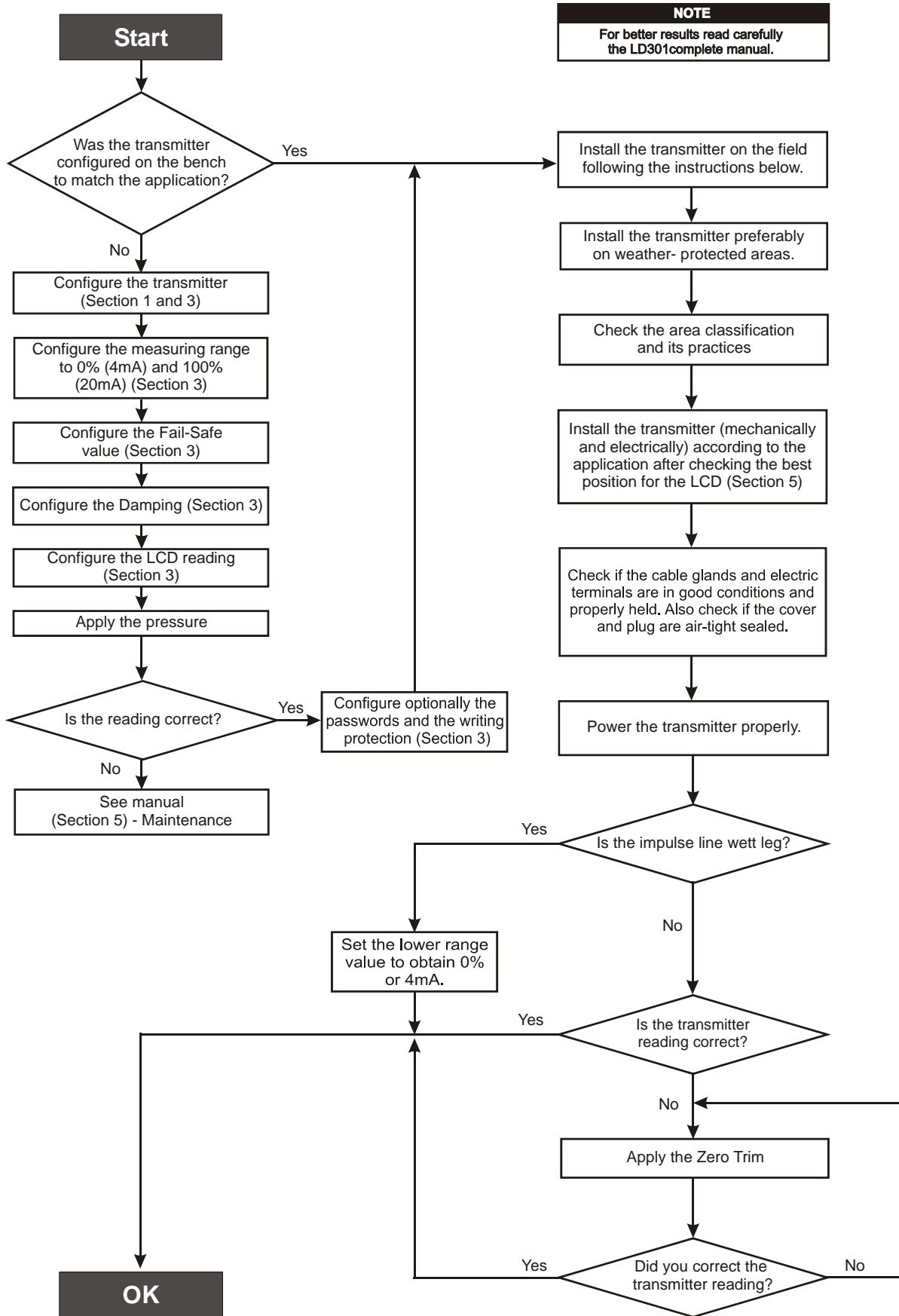

**NOTE**

For better results read carefully the LD301 complete manual.



## INSTALLATION

### General

#### NOTE

The installation carried out in hazardous areas should follow the recommendations of the IEC 60079-14 standard.

The overall accuracy of a flow, level, or pressure measurement depends on several variables. Although the transmitter has an outstanding performance, proper installation is essential to maximize its efficiency.

Among all factors, which may affect transmitter accuracy, environmental conditions are the most difficult to control. There are, however, ways of reducing the effects of temperature, humidity and vibration.

The **LD301** has a built-in temperature sensor to compensate for temperature variations. At the factory, each transmitter is submitted to a temperature cycle, and the characteristics under different temperatures are recorded in the transmitter memory. At the field, this feature minimizes the temperature variation effect.

### Mounting

Putting the transmitter in areas protected from extreme environmental changes can minimize temperature fluctuation effects.

In warm environments, the transmitter should be installed to avoid, as much as possible, direct exposure to the sun. Installation close to lines and vessels subjected to high temperatures should also be avoided. Use longer sections of impulse piping between tap and transmitter whenever the process fluid is at high temperatures. Use of sunshades or heat shields to protect the transmitter from external heat sources should be considered, if necessary.

Proper winterization (freeze protection) should be employed to prevent freezing within the measuring chamber, since this will result in an inoperative transmitter and could even damage the cell.

Although the transmitter is virtually insensitive to vibration, installation close to pumps, turbines or other vibrating equipment should be avoided.

The transmitter has been designed to be both rugged and lightweight at the same time. This makes its mounting easier. The mounting positions are shown in Figure 1.1.

Existing standards for the manifolds have also been considered, and standard designs fits perfectly to the transmitter flanges.

Should the process fluid contain solids in suspension, install valves or rod-out fittings regularly to clean out the pipes. The pipes should be internally cleaned by using steam or compressed air, or by draining the line with the process fluid, before such lines are connected to the transmitter (blow-down).

#### NOTE

When installing or storing the level transmitter, the diaphragm must be protected to avoid scratching-indenting or perforation of its surface. The process flange of the level transmitters can be rotated  $\pm 45^\circ$ . To do this just loosen the two screws (Figure 1.1) and rotate the flange. Do not take the screws out. There is a label (Figure 1.1) on the transmitter with these instructions.

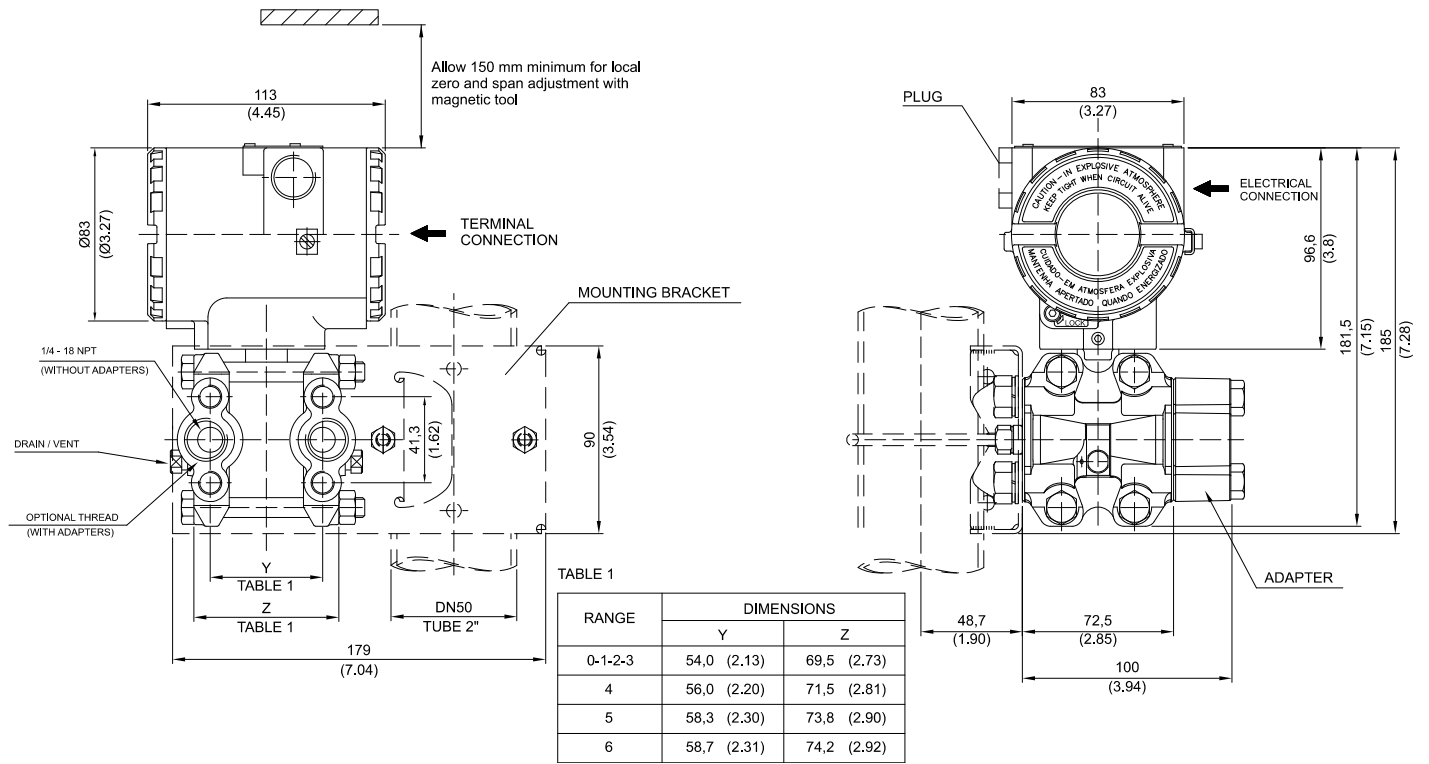
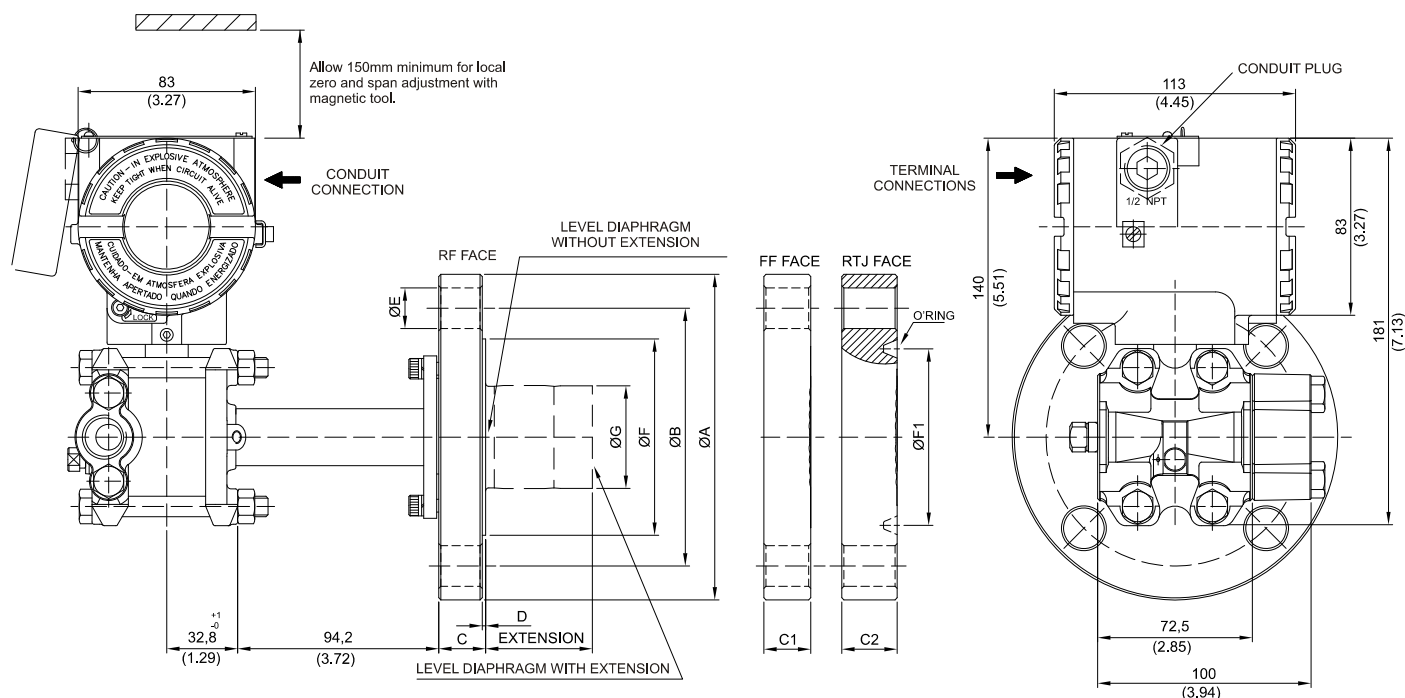

Figure 1.1 (a) – Dimensional Drawing and Mounting Position - Differential, Flow, Gage, Absolute and High Static Pressure Transmitters with Mounting Bracket



- Notes:
- Extension length (mm): 0, 50, 100, 150 or 200
  - Dimensions are mm (in)

ANSI-B 16.5 DIMENSIONS														
DN	CLASS	A	B	C (RF)	C1 (FF)	C2 (RTJ)	D (RF)	E	F (RF)	F1 (RTJ)	RTJ O'RING	G	HOLES	
1.1/2"	150	127 (5)	98.6 (3.88)	20 (0.78)	19 (0.75)	24.4 (0.96)	1.6 (0.06)	16 (0.63)	73.2 (2.88)	65.1 (2.56)	R19	40 (1.57)	4	
	300	155.4 (6.12)	114.3 (4.5)	21 (0.83)	21 (0.83)	27.4 (1.07)	1.6 (0.06)	22 (0.87)	73.2 (2.88)	68.3 (2.68)	R20	40 (1.57)	4	
	600	155.4 (6.12)	114.3 (4.5)	29.3 (1.15)	29.3 (1.15)	29.3 (1.15)	6.4 (0.25)	22 (0.87)	73.2 (2.88)	68.3 (2.68)	R20	40 (1.57)	4	
2"	150	152.4 (6)	120.7 (4.75)	22 (0.87)	20 (0.78)	25.9 (1.02)	1.6 (0.06)	19 (0.75)	91.9 (3.62)	82.6 (3.25)	R22	48 (1.89)	4	
	300	165.1 (6.5)	127 (5)	22.8 (0.9)	22.8 (0.89)	30.8 (1.21)	1.6 (0.06)	19 (0.75)	91.9 (3.62)	82.6 (3.25)	R23	48 (1.89)	8	
	600	165.1 (6.5)	127 (5)	32.3 (1.27)	32.3 (1.27)	32.3 (1.27)	6.4 (0.25)	19 (0.75)	91.9 (3.62)	82.6 (3.25)	R23	48 (1.89)	8	
3"	150	190.5 (7.5)	152.4 (6)	24.4 (0.96)	24.4 (0.96)	30.7 (1.21)	1.6 (0.06)	19 (0.75)	127 (5)	114.3 (4.50)	R29	73 (2.87)	4	
	300	209.5 (8.25)	168.1 (6.62)	29 (1.14)	29 (1.14)	36.9 (1.45)	1.6 (0.06)	22 (0.87)	127 (5)	123.8 (4.87)	R31	73 (2.87)	8	
	600	209.5 (8.25)	168.1 (6.62)	38.7 (1.52)	38.7 (1.52)	40.2 (1.58)	6.4 (0.25)	22 (0.87)	127 (5)	123.8 (4.87)	R31	73 (2.87)	8	
4"	150	228.6 (9)	190.5 (7.5)	24.4 (0.96)	24.4 (0.96)	30.7 (1.21)	1.6 (0.06)	19 (0.75)	158 (6.22)	149.2 (5.87)	R36	96 (3.78)	8	
	300	254 (10)	200 (7.87)	32.2 (1.27)	32.2 (1.27)	40.2 (1.58)	1.6 (0.06)	22 (0.87)	158 (6.22)	149.2 (5.87)	R37	96 (3.78)	8	
	600	273 (10.75)	215.9 (8.5)	45 (1.77)	45 (1.77)	46.5 (1.83)	6.4 (0.25)	25 (1)	158 (6.22)	149.2 (5.87)	R37	96 (3.78)	8	
EN 1092-1 DIMENSIONS														
DN	PN	A	B	C (RF)	C1 (FF)		D	E	F (RF)			G	HOLES	
DN40	10/40	150 (5.9)	110 (4.33)	20 (0.78)	20 (0.78)		3 (0.12)	18 (0.71)	88 (3.46)			40 (1.57)	4	
DN50	10/40	165 (6.5)	125 (4.92)	20 (0.78)	22 (0.86)		3 (0.12)	18 (0.71)	102 (4.01)			48 (1.89)	4	
DN80	10/40	200 (7.87)	160 (6.3)	24 (0.95)	24 (0.94)		3 (0.12)	18 (0.71)	138 (5.43)			73 (2.87)	8	
DN100	10/16	220 (8.67)	180 (7.08)	20 (0.78)			3 (0.12)	18 (0.71)	158 (6.22)			96 (3.78)	8	
	25/40	235 (9.25)	190 (7.5)	24 (0.95)			3 (0.12)	22 (0.87)	162 (6.38)			96 (3.78)	8	
JIS B 2202 DIMENSIONS														
DN	CLASS	A	B	C			D	E	F (RF)			G	HOLES	
40A	20K	140 (5.5)	105 (4.13)	26 (1.02)			2 (0.08)	19 (0.75)	81 (3.2)			40 (1.57)	4	
50A	10K	155 (6.1)	120 (4.72)	26 (1.02)			2 (0.08)	19 (0.75)	96 (3.78)			48 (1.89)	4	
	40K	165 (6.5)	130 (5.12)	26 (1.02)			2 (0.08)	19 (0.75)	105 (4.13)			48 (1.89)	8	
80A	10K	185 (7.28)	150 (5.9)	26 (1.02)			2 (0.08)	19 (0.75)	126 (4.96)			73 (2.87)	8	
	20K	200 (7.87)	160 (6.3)	26 (1.02)			2 (0.08)	19 (0.75)	132 (5.2)			73 (2.87)	8	
100A	10K	210 (8.27)	175 (6.89)	26 (1.02)			2 (0.08)	19 (0.75)	151 (5.95)			96 (3.78)	8	

Figure 1.1 (b) – Dimensional Drawing and Mounting Position - Flanged Pressure Transmitter with Integral Flange

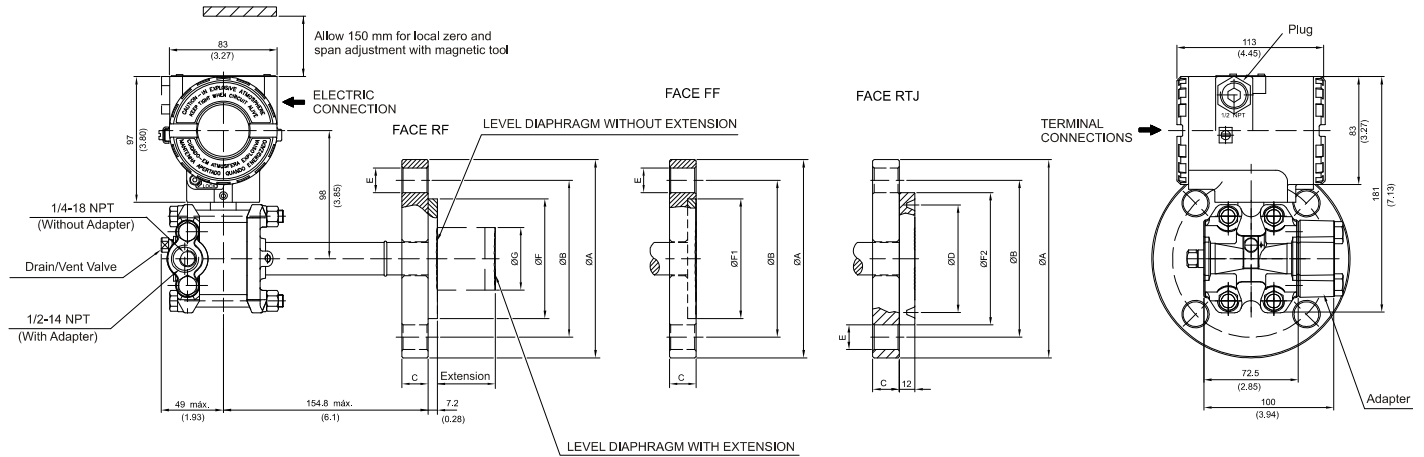

ANSI-B 16.5 DIMENSIONS												
DN	CLASS	A	B	C	D	E	F (RF)	F1 (FF)	F2 (RTJ)	G	HOLES	
1"	150	108 (4.25)	79.4 (3.16)	14.3 (0.56)	-	16 (0.63)	50.8 (2)	50.8 (2)	-	-	4	
	300/600	124 (4.88)	88.9 (3.5)	17.5 (0.69)	-	19 (0.75)	50.8 (2)	50.8 (2)	-	-	4	
1 1/2"	150	127 (5)	98.4 (3.87)	17.5 (0.69)	-	16 (0.63)	73 (2.87)	73 (2.87)	-	40 (1.57)	4	
	300/600	156 (6.14)	114.3 (4.5)	22.2 (0.87)	-	22 (0.87)	73 (2.87)	73 (2.87)	-	40 (1.57)	4	
2"	150	152.4 (6)	120.7 (4.75)	17.5 (0.69)	82.6 (3.25)	19 (0.75)	92 (3.62)	92 (3.62)	101.6 (4.00)	48 (1.89)	4	
	300	165.1 (6.5)	127 (5)	20.7 (0.8)	82.6 (3.25)	19 (0.75)	92 (3.62)	92 (3.62)	107.9 (4.25)	48 (1.89)	8	
	600	165.1 (6.5)	127 (5)	25.4 (1)	82.6 (3.25)	19 (0.75)	92 (3.62)	92 (3.62)	107.9 (4.25)	48 (1.89)	8	
3"	150	190.5 (7.5)	152.4 (6)	22.3 (0.87)	114.3 (4.50)	19 (0.75)	127 (5)	127 (5)	133.4 (5.25)	73 (2.87)	4	
	300	209.5 (8.25)	168.1 (6.62)	27 (1.06)	123.8 (4.87)	22 (0.87)	127 (5)	127 (5)	146.1 (5.75)	73 (2.87)	8	
	600	209.5 (8.25)	168.1 (6.62)	31.8 (1.25)	123.8 (4.87)	22 (0.87)	127 (5)	127 (5)	146.1 (5.75)	73 (2.87)	8	
4"	150	228.6 (9)	190.5 (7.5)	22.3 (0.87)	149.2 (5.87)	19 (0.75)	158 (6.22)	158 (6.22)	171.5 (6.75)	89 (3.5)	8	
	300	254 (10)	200 (7.87)	30.2 (1.18)	149.2 (5.87)	22 (0.87)	158 (6.22)	158 (6.22)	174.6 (6.87)	89 (3.5)	8	
	600	273 (10.75)	215.9 (8.5)	38.1 (1.5)	149.2 (5.87)	25 (1)	158 (6.22)	158 (6.22)	174.6 (6.87)	89 (3.5)	8	

EN 1092-1 / DIN2501 DIMENSIONS - RF/ FF									
DN	PN	A	B	C	E	F	G	HOLES	
25	10/40	115 (4.53)	85 (3.35)	18 (0.71)	14 (0.55)	68 (2.68)	-	4	
40	10/40	150 (5.91)	110 (4.33)	18 (0.71)	18 (0.71)	88 (3.46)	73 (2.87)	4	
50	10/40	165 (6.50)	125 (4.92)	20 (0.78)	18 (0.71)	102 (4.01)	48 (1.89)	4	
80	10/40	200 (7.87)	160 (6.30)	24 (0.95)	18 (0.71)	138 (5.43)	73 (2.87)	8	
100	10/16	220 (8.67)	180 (7.08)	20 (0.78)	18 (0.71)	158 (6.22)	89 (3.5)	8	
	25/40	235 (9.25)	190 (7.50)	24 (0.95)	22 (0.87)	162 (6.38)	89 (3.5)	8	

NOTES:  
 -EXTENSION LENGTH IN mm(in): 0, 50 (1.96), 100 (3.93), 150(5.9) or 200 (7.87)  
 -DIMENSIONS IN mm(in)

Figure 1.1 (c) – Dimensional Drawing and Mounting Position - Flanged Pressure Transmitter with Slip-on Flange

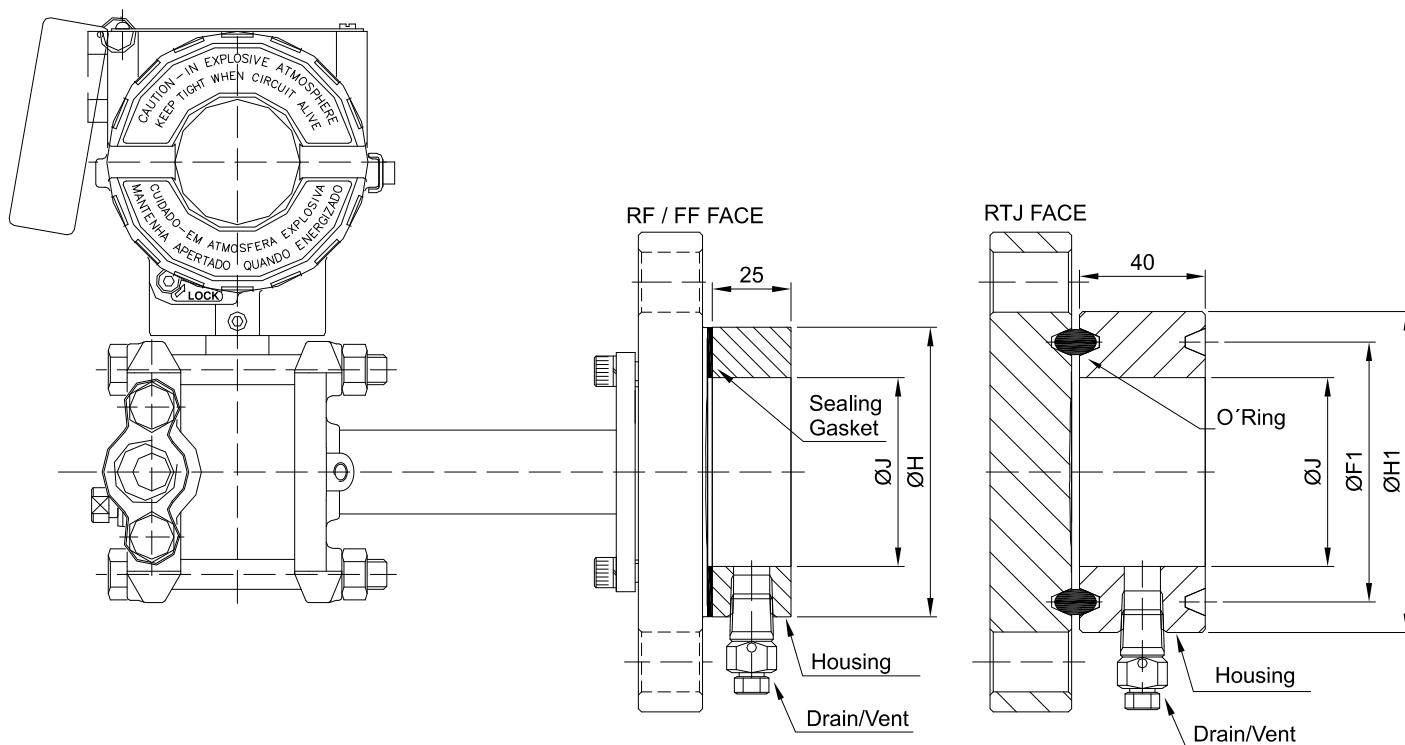

DIMENSIONS IN mm (")

ANSI-B 16.5 DIMENSIONS			
DN	CLASS	H	J
1.1/2"	ALL	73,2 (2,88)	48 (1,89)
2"		91,9 (3,62)	60 (2,36)
3"		127 (5,00)	89 (3,50)
4"		158 (6,22)	115 (4,53)
DIN EN1092-1/ DIN2501/2526 FORM D DIMENSIONS			
DN	PN	H	J
40	ALL	88 (3,46)	48 (1,89)
50		102 (4,02)	60 (2,36)
80		138 (5,43)	89 (3,50)
100		158 (6,22)	115 (4,53)
JIS B 2202 DIMENSIONS			
DN	CLASS	H	J
40A	20K	81 (3,19)	48 (1,89)
50A	10K	96 (3,78)	60 (1,36)
	40K	105 (4,13)	60 (1,36)
80A	10K	126 (4,96)	89 (3,50)
	20K	132 (5,20)	89 (3,50)
100A	10K	151 (5,94)	115 (4,53)

DIMENSIONS IN mm (")

ANSI-B 16.5 DIMENSIONS - RTJ FACE					
DN	CLASS	F1	O-RING	H1	J
1.1/2"	150	65,1 (2,56)	R19	82,5 (3,25)	48 (1,89)
	300	68,3 (2,69)	R20	90,5 (3,56)	48 (1,89)
	600	68,3 (2,69)	R20	90,5 (3,56)	48 (1,89)
	1500	68,3 (2,69)	R20	92 (3,62)	48 (1,89)
2"	2500	82,6 (3,25)	R23	114 (4,50)	48 (1,89)
	150	82,6 (3,25)	R22	102 (4,00)	60 (2,36)
	300	82,6 (3,25)	R23	108 (4,25)	60 (2,36)
	600	82,6 (3,25)	R23	108 (4,25)	60 (2,36)
	1500	95,3 (3,75)	R24	124 (4,88)	60 (2,36)
3"	2500	101,6 (4,00)	R26	133 (5,25)	60 (2,36)
	150	114,3 (4,50)	R29	133 (5,25)	89 (3,50)
	300	123,8 (4,87)	R31	146 (5,75)	89 (3,50)
	600	123,8 (4,87)	R31	146 (5,75)	89 (3,50)
4"	150	149,2 (5,87)	R36	171 (6,75)	115 (4,53)
	300	149,2 (5,87)	R37	175 (6,88)	115 (4,53)
	600	149,2 (5,87)	R37	175 (6,88)	115 (4,53)

Figure 1.1 (d) – Dimensional Drawing and Mounting Position - Flanged Pressure Transmitter with Housing

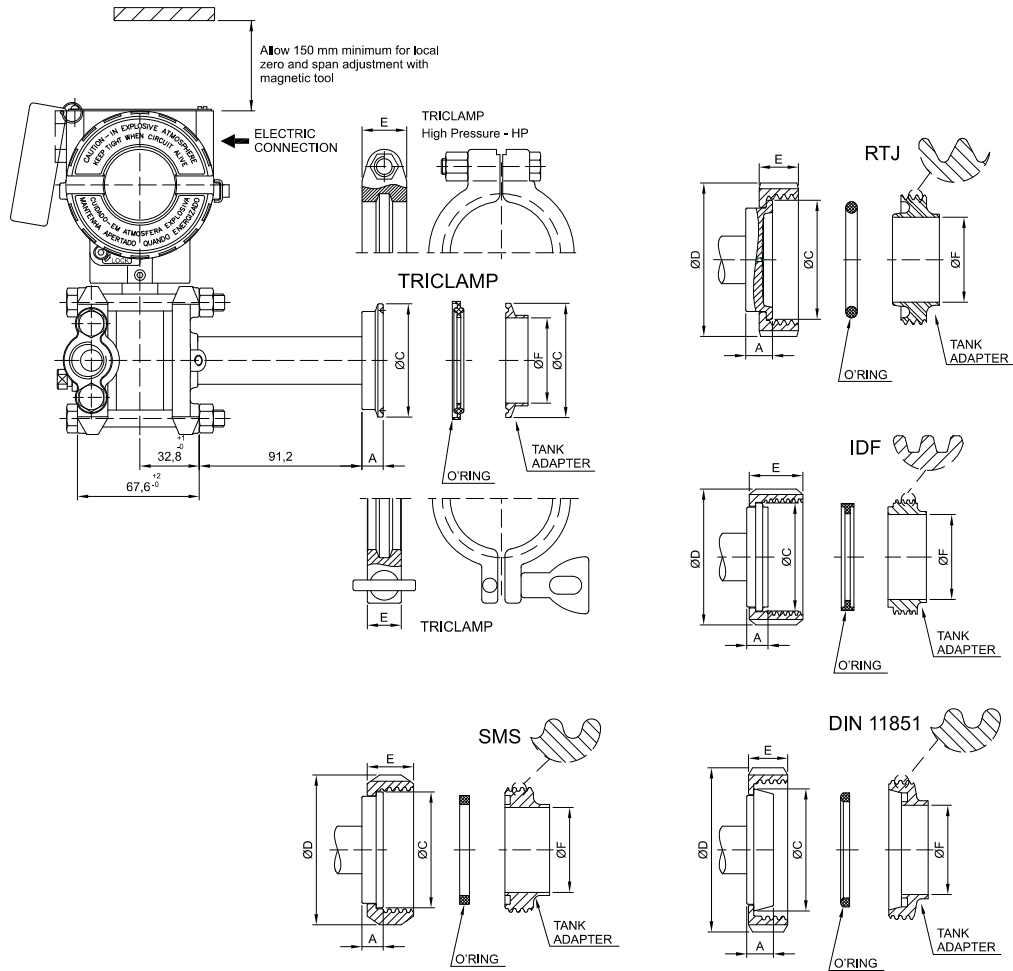

LD300S							
CONNECTION WITHOUT EXTENSION	Dimensions in mm (")						
	A	ØC	ØD	E	ØF	ØG	EXT.
Tri-Clamp DN50	8 (0.315)	63.5 (2.5)	76.5 (3.01)	18 (0.71)	47.5 (1.87)	--	--
Tri-Clamp - 1 1/2"	12 (0.47)	50 (1.96)	61 (2.4)	18 (0.71)	35 (1.38)	--	--
Tri-Clamp - 1 1/2" HP	12 (0.47)	50 (1.96)	66 (2.59)	25 (0.98)	35 (1.38)	--	--
Tri-Clamp - 2"	12 (0.47)	63.5 (2.5)	76.5 (3.01)	18 (0.71)	47.6 (1.87)	--	--
Tri-Clamp - 2" HP	12 (0.47)	63.5 (2.5)	81 (3.19)	25 (0.98)	47.6 (1.87)	--	--
Tri-Clamp - 3"	12 (0.47)	91 (3.58)	110 (4.33)	18 (0.71)	72 (2.83)	--	--
Tri-Clamp - 3" HP	12 (0.47)	91 (3.58)	115 (4.53)	25 (0.98)	72 (2.83)	--	--
Threaded DN40 - DIN 11851	13 (0.51)	56 (2.2)	78 (3.07)	21 (0.83)	38 (1.5)	--	--
Threaded DN50 - DIN 11851	15 (0.59)	68.5 (2.7)	92 (3.62)	22 (0.86)	50 (1.96)	--	--
Threaded DN80 - DIN 11851	16 (0.63)	100 (3.94)	127 (5)	29 (1.14)	81 (3.19)	--	--
Threaded SMS - 1 1/2"	12 (0.47)	55 (2.16)	74 (2.91)	25 (0.98)	35 (1.38)	--	--
Threaded SMS - 2"	12 (0.47)	65 (2.56)	84 (3.3)	26 (1.02)	48.6 (1.91)	--	--
Threaded SMS - 3"	12 (0.47)	93 (3.66)	113 (4.45)	32 (1.26)	73 (2.87)	--	--
Threaded RJT - 2"	15 (0.59)	66.7 (2.63)	86 (3.38)	22 (0.86)	47.6 (1.87)	--	--
Threaded RJT - 3"	15 (0.59)	92 (3.62)	112 (4.41)	22.2 (0.87)	73 (2.87)	--	--
Threaded IDF - 2"	12 (0.47)	60.5 (2.38)	76 (2.99)	30 (1.18)	47.6 (1.87)	--	--
Threaded IDF - 3"	12 (0.47)	87.5 (3.44)	101.6 (4)	30 (1.18)	73 (2.87)	--	--

Figure 1.1 (e) – Dimensional Drawing and Mounting Position - Sanitary Transmitter without Extension

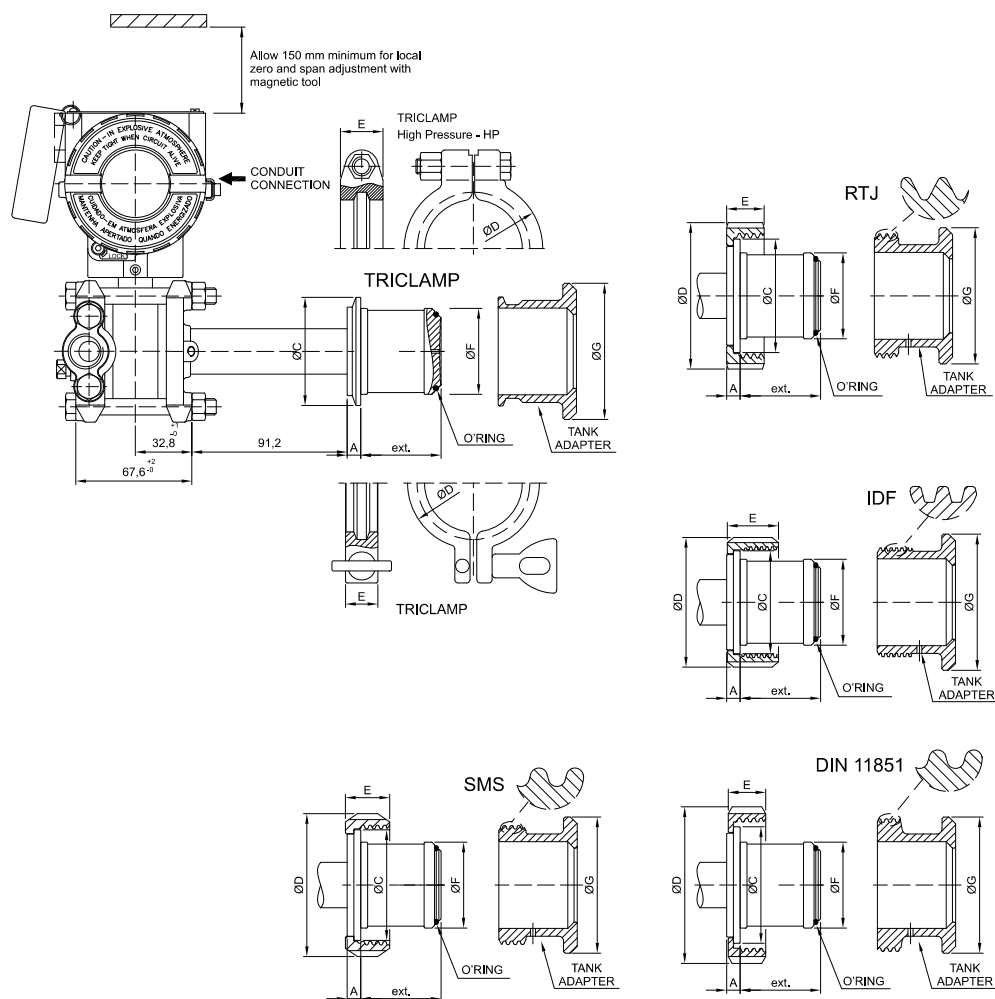

LD300S							
CONNECTION WITH EXTENSION	Dimensions in mm (")						
	A	ØC	ØD	E	ØF	ØG	EXT.
Tri-Clamp DN50	8 (0.315)	63.5 (2.5)	76.5 (3.01)	18 (0.71)	50.5 (1.99)	80 (3.15)	48 (1.89)
Tri-Clamp DN50 HP	8 (0.315)	63.5 (2.5)	81 (3.19)	25 (0.98)	50.5 (1.99)	80 (3.15)	48 (1.89)
Tri-Clamp - 2"	8 (0.315)	63.5 (2.5)	76.5 (3.01)	18 (0.71)	50.5 (1.99)	80 (3.15)	48 (1.89)
Tri-Clamp - 2" HP	8 (0.315)	63.5 (2.5)	81 (3.19)	25 (0.98)	50.5 (1.99)	80 (3.15)	48 (1.89)
Tri-Clamp - 3"	8 (0.315)	91 (3.58)	110 (4.33)	18 (0.71)	72.5 (2.85)	100 (3.94)	50 (1.96)
Tri-Clamp - 3" HP	8 (0.315)	91 (3.58)	115 (4.53)	25 (0.98)	72.5 (2.85)	100 (3.94)	50 (1.96)
Threaded DN25 - DIN 11851	6 (0.24)	47.5 (1.87)	63 (2.48)	21 (0.83)	43.2 (1.7)	80 (3.15)	26.3 (1.03)
Threaded DN40 - DIN 11851	8 (0.315)	56 (2.2)	78 (3.07)	21 (0.83)	50.5 (1.99)	80 (3.15)	48 (1.89)
Threaded DN50 - DIN 11851	8 (0.315)	68.5 (2.7)	92 (3.62)	22 (0.86)	50.5 (1.99)	80 (3.15)	48 (1.89)
Threaded DN80 - DIN 11851	8 (0.315)	100 (3.94)	127 (5)	29 (1.14)	72.5 (2.85)	100 (3.94)	50 (1.96)
Threaded SMS - 2"	8 (0.315)	65 (2.56)	84 (3.3)	26 (1.02)	50.5 (1.99)	80 (3.15)	48 (1.89)
Threaded SMS - 3"	8 (0.315)	93 (3.66)	113 (4.45)	32 (1.26)	72.5 (2.85)	100 (3.94)	50 (1.96)
Threaded RJT - 2"	8 (0.315)	66.7 (2.63)	86 (3.38)	22 (0.86)	50.5 (1.99)	80 (3.15)	48 (1.89)
Threaded RJT - 3"	8 (0.315)	92 (3.62)	112 (4.41)	22.2 (0.87)	72.5 (2.85)	100 (3.94)	50 (1.96)
Threaded IDF - 2"	8 (0.315)	60.5 (2.38)	76.2 (3)	30 (1.18)	50.5 (1.99)	80 (3.15)	48 (1.89)
Threaded IDF - 3"	8 (0.315)	87.5 (3.44)	101.6 (4)	30 (1.18)	72.5 (2.85)	100 (3.94)	50 (1.96)

Figure 1.1 (f) – Dimensional Drawing and Mounting Position - Sanitary Transmitter with Extension

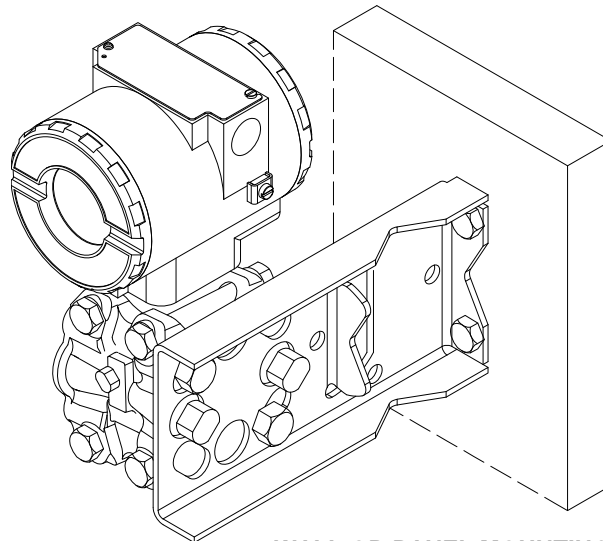

**WALL OR PANEL MOUNTING**  
(See Section 5 – spare parts list for mounting brackets available)

**Figure 1.2 – Drawing of LD301 Mounted on the Panel or Wall**

Observe operating safety rules during wiring, draining or blow-down.

**WARNING**

Normal safety precautions must be taken to avoid the possibility of an accident occurring when operating in conditions of high pressure and/or temperature.

**Electrical shock can result in death or serious injury.**

Avoid contact with the leads and terminals.

**Process leaks could result in death or serious injury.**

Do not attempt to loosen or remove flange bolts while the transmitter is in service.

**Replacement equipment or spare parts not approved by Smar could reduce the pressure retaining capabilities of the transmitter and may render the instrument dangerous.**

Use only bolts supplied or sold by Smar as spare parts.

Some examples of installation, illustrating the transmitter position in relation to the taps, are shown in Figure 1.3. The pressure taps location and the relative positions of the transmitter are indicated in Table 1.1.

Process Fluid	Location of	Location of LD301 in Relation to the Taps
Gas	Top or Side	Above the Taps
Liquid	Side	Below the Taps or at the Piping Centerline
Steam	Side	Below the Taps using Sealing (Condensate) Pots

**Table 1.1 - Location of Pressure Taps**

**NOTE**

For liquids, condensates, wet vapors and gases the impulse lines must be bent on the ratio 1:10 to prevent bubbles from accumulating;

The transmitter and its impulse lines must be tightly fixed;

If necessary, install the condensate and mud pots;

Use manifold valves to facilitate maintenance and adjustments.



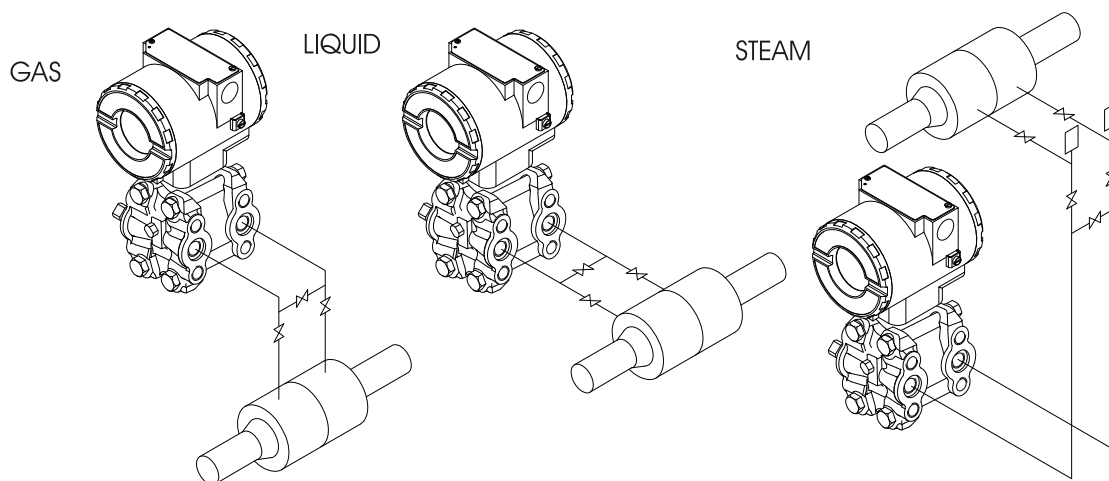
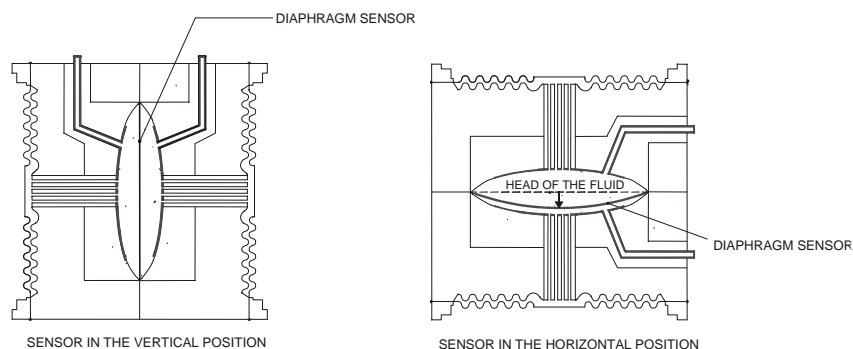

**Figure 1.3 – Position of the Transmitter and Taps**

#### NOTE

The transmitters are calibrated in the vertical position and a different mounting position displaces the zero point. Consequently, the indicator will indicate a different value from the applied pressure. In these conditions, it is recommended to do the zero pressure trim. The zero trim compensates the final assembly position and its performance, when the transmitter is in its final position. When the zero trim is executed, make sure the equalization valve is open and the wet leg levels are correct.

For the absolute pressure transmitter, the assembly effects correction should be done using the Lower trim, due to the fact that the absolute zero is the reference for these transmitters, so there is no need for a zero value for the Lower trim.



## Electronic Housing

Humidity is fatal to electronic circuits. In areas subjected to high relative humidity, the O-rings for the electronic housing covers must be correctly placed and the covers must be completely closed by tightening them by hand until you feel the O-rings being compressed. Do not use tools to close the covers. Removal of the electronics cover in the field should be reduced to the minimum necessary, since each time it is removed; the circuits are exposed to the humidity.

The electronic circuit is protected by a humidity proof coating, but frequent exposures to humidity may affect the protection provided. It is also important to keep the covers tightened in place. Every time they are removed, the threads are exposed to corrosion, since painting cannot protect these parts. Sealing methods should be employed on conduit entering the transmitter. The unused outlet connection should be properly plugged.

#### WARNING

The unused cable entries should be plugged and sealed accordingly to avoid humidity entering, which can cause the loss of the product's warranty.

The electronic housing can be rotated to adjust the digital display on a better position. To rotate it, loose the Housing Rotation Set Screw, see Figure 1.4 (a). To prevent humidity entering, the electric housing and the sensor joint must have a minimum of 6 fully engaged threads. The provided joint allows 1 extra turn to adjust the position of the display window by rotating the housing clockwise. If the thread reaches the end before the desired position, then rotate the housing counterclockwise, but not more than one thread turn. Transmitters have a stopper that restricts housing rotation to one turn. See Section 5, Figure 5.2.

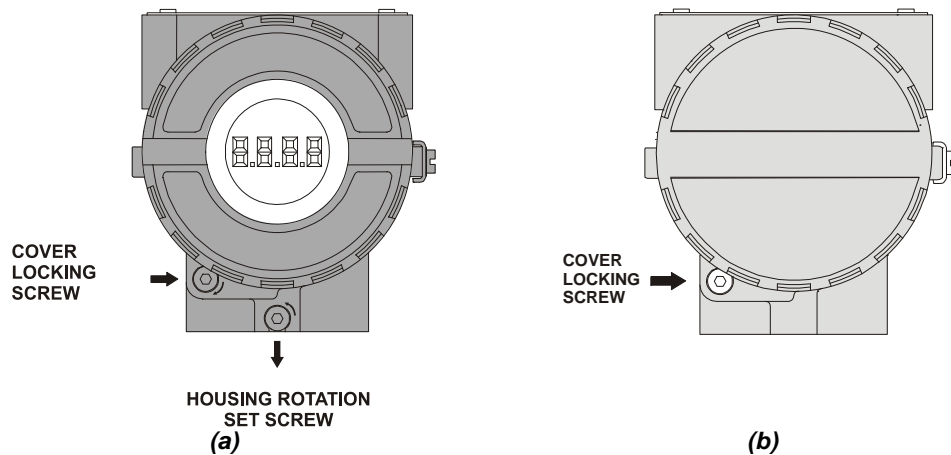

Figure 1.4 - Cover Locking and Housing Rotating Set Screw (a) Electronic Board Side (b) Terminal Connection Side

## Wiring

To access the wiring block, loosen the cover locking screw to release the cover. See Figure 1.4 (b).

**Test** and **Communication terminals** allow, respectively, to measure the current in the 4 - 20 mA loop, without opening the circuit, and also to communicate with the transmitter. The "Test Terminals" must be used to measure the current. The "COMM" terminal must be used for HART communication. The terminal block has screws where fork or ring-type terminals can be fastened. See Figure 1.5.

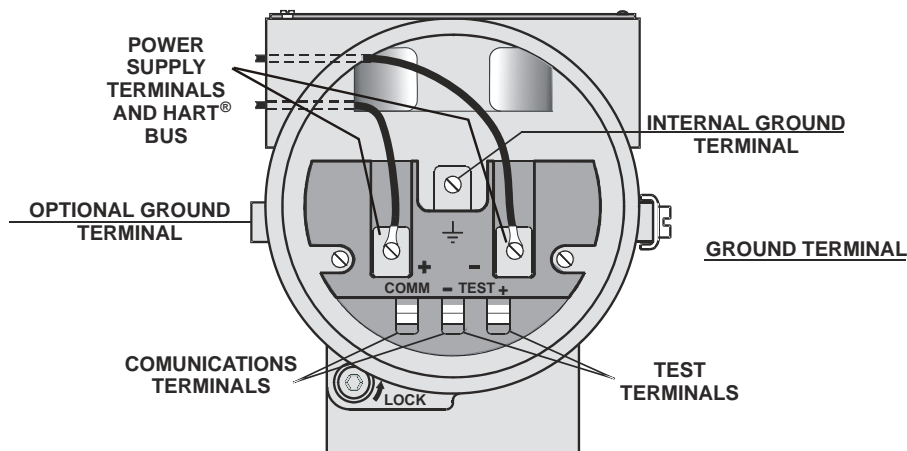

Figure 1.5 – Terminal Block

The LD301 is protected against reverse polarity.

For convenience there are three ground terminals: one inside the cover and two external, located close to the conduit inlets.

Use of twisted pair (22 AWG or greater than) cables is recommended. For sites with high electromagnetic levels (EMI above 10 V/m) shield conductors are recommended.

Avoid routing signal wiring near to power cables or switching equipment.

The Figure 1.6 shows the correct conduit installation, to avoid penetration of water or other substance, which may cause equipment malfunction.

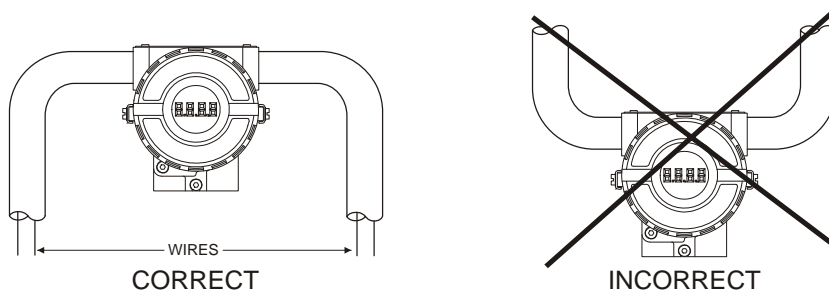

Figure 1.6 - Conduit Installation

## Loop Connections

Figures 1.7 and 1.8 show **LD301**'s wiring diagrams to work as transmitter and controller, respectively.

Figure 1.9 shows the **LD301**'s wiring diagrams to work in the multi-drop network. Note that a maximum of 15 transmitters can be connected on the same line and that they should be connected in parallel. Take care to the power supply as well, when many transmitters are connected on the same line. The current through the 250 Ohm resistor will be high causing a high voltage drop. Therefore make sure that the power supply voltage is sufficient.

The Hand-Held Terminal can be connected to the communication terminals of the transmitter or at any point of the signal line by using the alligator clips. It is also recommended to ground the shield of shielded cables at only one end. The ungrounded end must be carefully isolated. On multi-drop connections, the circuit loop integrity must be assured, with special care to prevent short-circuit between the circuit loop and the housing.

**NOTE**

For HART transmitters to operate in multi-drop mode each transmitter must be configured with a different identity Device ID. In addition, if the transmitter identification mode on the loop is done through the Command 0 address, the HART address must also be different. If it is done through the (Command 11) Tag the Tags must be similar.

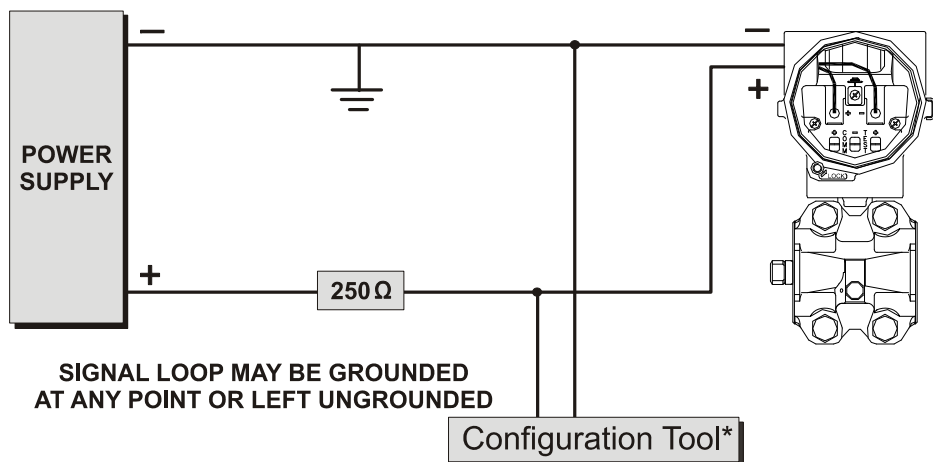

\* PC BASED TOOL OR HAND HELD TERMINAL

Figure 1.7 - Wiring Diagram for the LD301 Working as a Transmitter

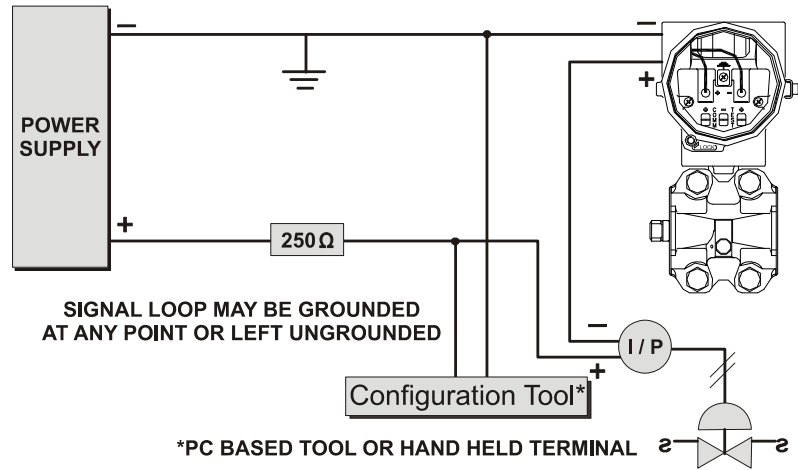
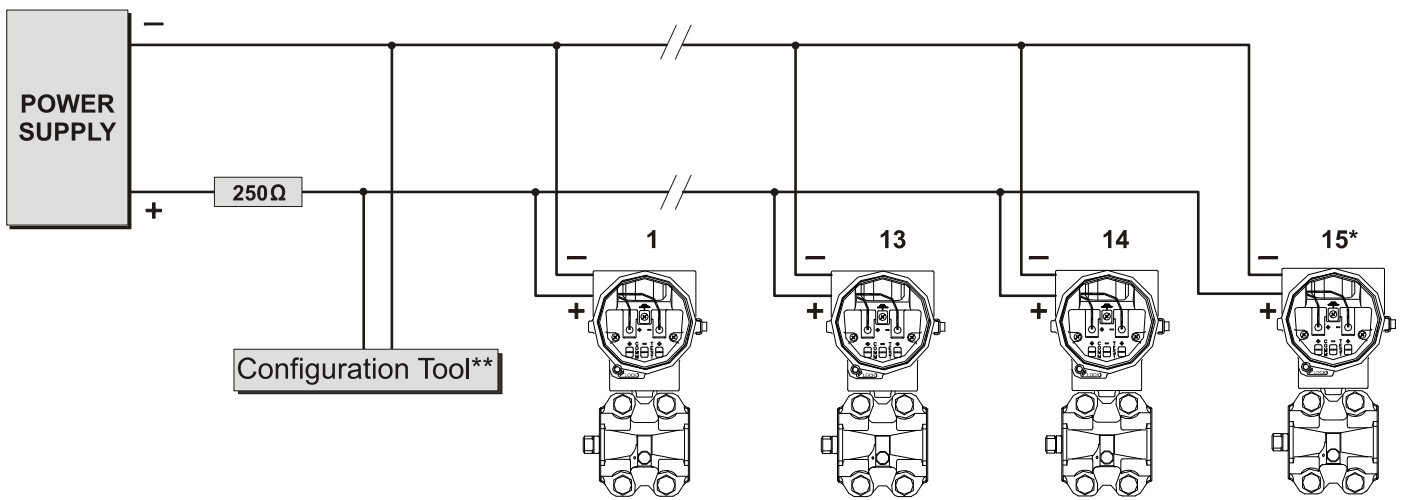

Figure 1.8 - Wiring Diagram for the LD301 Working as a Controller



\* MAXIMUM NUMBER WITHOUT CONSIDERING INTRINSIC SAFETY  
 \*\* PC BASED TOOL OR HAND HELD TERMINAL

Figure 1.9 - Wiring Diagram for the LD301 in Multidrop Configuration

**NOTE**  
 Make sure that the transmitter is operating within the operating area as shown on the load curve (Figure 1.10). Communication requires a minimum load of 250 Ohm and voltage equal to 17 Vdc.

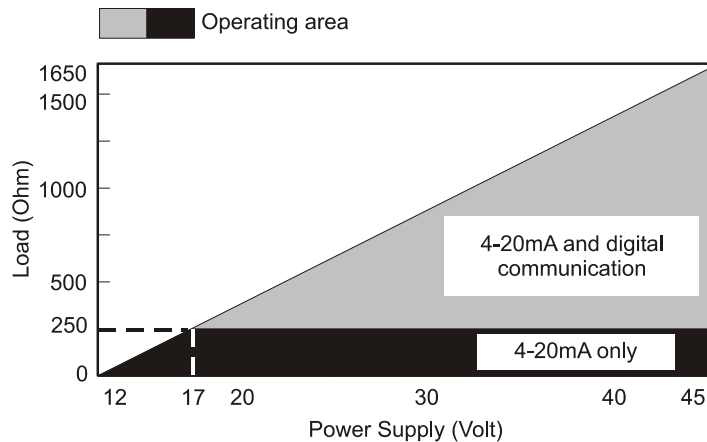

Figure 1.10 – Load Limitation

## Installation in Hazardous Areas

### WARNING

Explosions could result in death or serious injury, besides financial damage. Installation of this transmitter in explosive areas must be carried out in accordance with the local standards and the protection type adopted. Before continuing the installation make sure the certificate parameters are in accordance with the classified area where the equipment will be installed.

The instrument modification or parts replacement supplied by other than authorized representative of Smar is prohibited and will void the certification.

The transmitters are marked with options of the protection type. The certification is valid only when the protection type is indicated by the user. Once a particular type of protection is selected, any other type of protection can not be used.

The electronic housing and the sensor installed in hazardous areas must have a minimum of 6 fully engaged threads. Lock the housing using the locking screw (Figure 1.4).

The cover must be tighten with at least 8 turns to avoid the penetration of humidity or corrosive gases. The cover must be tighten until it touches the housing. Then, tighten more 1/3 turn (120°) to guarantee the sealing. Lock the covers using the locking screw (Figure 1.4).

Consult the Appendix A for further information about certification.

## Explosion/Flame Proof

### WARNING

In Explosion-Proof installations the cable entries must be connected or closed using metal cable gland and metal blanking plug, both with at least IP66 and Ex-d certification.

As the transmitter is non-ignition capable under normal conditions, the statement "Seal not Required" could be applied for Explosion Proof Version. (CSA Certification).

The standard plugs provided by Smar are certified according to the standards at FM, CSA and CEPEL. If the plug needs to be replaced, a certified plug must be used.

The electrical connection with NPT thread must use waterproofing sealant. A non-hardening silicone sealant is recommended.

**Do not remove the transmitter covers when power is ON.**

## Intrinsically Safe

### WARNING

In hazardous zones with intrinsically safe or non-incendive requirements, the circuit entity parameters and applicable installation procedures must be observed.

To protect the application the transmitter **must be connected to a barrier**. Match the parameters between barrier and the equipment (Consider the cable parameters). Associated apparatus ground bus shall be insulated from panels and mounting enclosures. Shield is optional. If used, be sure to insulate the end not grounded. Cable capacitance and inductance plus  $C_i$  and  $L_i$  must be smaller than  $C_o$  and  $L_o$  of the associated Apparatus.

For free access to the Hart bus in the explosive environment, ensure the instruments in the loop are installed in accordance with intrinsically safe or non-incendive field wiring practices. Use only Ex Hart communicator approved according to the type of protection Ex-i (IS) or Ex-n (NI).

It is not recommended to remove the transmitter cover when the power is ON.



## OPERATION

### Functional Description - Sensor

The LD301 Series Intelligent Pressure Transmitters use capacitive sensors (capacitive cells) as pressure sensing elements, as shown in Figure 2.1.

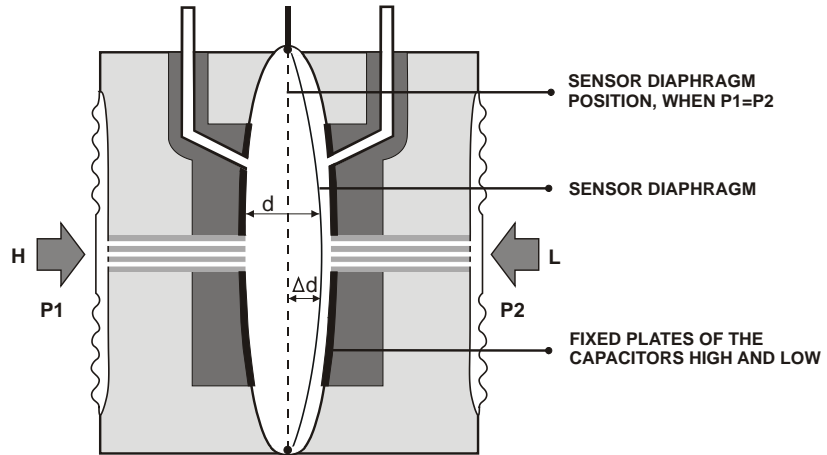

Figure 2.1 – Capacitive Cell

Where,

**P<sub>1</sub>** and **P<sub>2</sub>** are the pressures in chambers **H** and **L**.

**CH** = capacitance between the fixed plate on **P<sub>1</sub>** side and the sensing diaphragm.

**CL** = capacitance between the fixed plate on the **P<sub>2</sub>** side and the sensing diaphragm.

**d** = distance between **CH** and **CL** fixed plates.

**Δd** = sensing diaphragm's deflection due to the differential pressure  $\Delta P = P_1 - P_2$ .

Knowing that the capacitance of a capacitor with flat, parallel plates may be expressed as a function of plate area (**A**) and distance (**d**) between the plates as:

$$C = \frac{\epsilon A}{d}$$

Where,

$\epsilon$  = dielectric constant of the medium between the capacitor's plates.

Should **CH** and **CL** be considered as capacitances of flat and parallel plates with identical areas, then:

$$CH = \frac{\epsilon \cdot A}{(d/2) + \Delta d} \quad \text{and} \quad CL = \frac{\epsilon \cdot A}{(d/2) - \Delta d}$$

However, should the differential pressure ( $\Delta P$ ) apply to the capacitive cell not deflect the sensing diaphragm beyond  $d/4$ , it is possible to assume  $\Delta P$  as proportional to  $\Delta d$ , that is:

$\Delta P$  is proportional  $\Delta d$ .

By developing the expression  $(CL - CH)/(CL + CH)$ , it follows that:

$$\Delta P = \frac{CL - CH}{CL + CH} = \frac{2\Delta d}{d}$$

As the distance (**d**) between the fixed plates **CH** and **CL** is constant, it is possible to conclude that the expression  $(CL - CH)/(CL + CH)$  is proportional to  $\Delta d$  and, therefore, to the differential pressure to be measured.

Thus it is possible to conclude that the capacitive cell is a pressure sensor formed by two capacitors whose capacitances vary according to the applied differential pressure.

## Functional Description - Hardware

Refer to the block diagram Figure 2.2. The function of each block is described below.

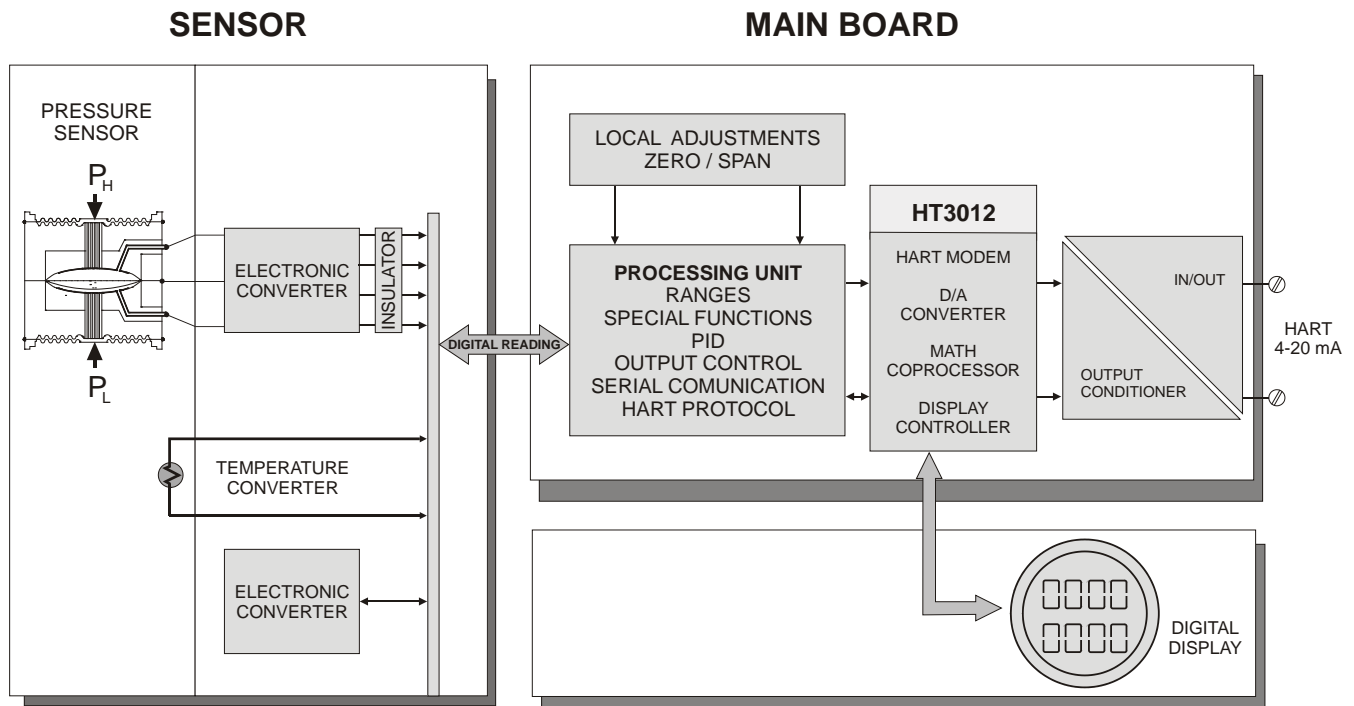

Figure 2.2 – LD301 Block Diagram Hardware

### Oscillator

This oscillator generates a frequency as a function of sensor capacitance.

### Signal Isolator

The Control signals from the CPU are transferred through optical couplers, and the signal from the oscillator is transferred through a transformer.

### Central Processing Unit (CPU) and PROM

The CPU is the intelligent portion of the transmitter, being responsible for the management and operation of all other blocks, linearization and communication.

The program is stored in an external PROM. For temporary storage of data the CPU has an internal RAM. The data in the RAM is lost, if the power is switched off, although the CPU also has an internal nonvolatile EEPROM where data that must be retained is stored. Examples of such data are: calibration, configuration and identification data.

### EEPROM

Another EEPROM is located within the sensor assembly. It contains data pertaining to the sensor's characteristics at different pressures and temperatures. This characterization is done for each sensor at the factory.

### D/A Converter

It converts the digital data from the CPU to an analog signal with 14-bits resolution.

### Output

It controls the current in the line feeding the transmitters.

It acts as a variable resistive load whose value depends on the voltage from the D/A converter.

### Modem

This system provides the data exchanged between the serve-master digital communications. The transmitter demodulates information from the current line, and after treating it adequately, modulates over the line the answer to be sent. A "1" is represented by 1200 Hz and "0" by 2200 Hz. The frequency signal is symmetrical and does not affect the DC-level of the 4-20 mA signal.



**Power Supply**

Power shall be supplied to the transmitter circuit using the signal line (2-wire system). The transmitter quiescent consumption is 3.6 mA; during operation, consumption may be as high as 21 mA, depending on the measurement and sensor status.

The **LD301** in the transmitter mode shows failure indication at 3.6 mA if configured for low signal failure; at 21 mA, if configured for high signal failure; 3.8 mA in the case of low saturation; 20.5 mA in the case of high saturation and measurements proportional to the applied pressure in the range between 3.8 mA and 20.5 mA. 4 mA corresponds to 0% of the working range and 20 mA to 100 % of the working range.

**Power Supply Isolation**

The sensor power supply is isolated from the main circuit by this module.

**Display Controller**

It receives the data from the CPU and activates the LCD segments. It also activates the back plane and the control signals for each segment.

**Local Adjustment**

Two switches on the main board are magnetically activated by inserting the magnetic tool.

## Functional Description - Software

Refer to the block diagram Figure 2.3. The function of each block is described below.

**Digital Filter**

The digital filter is a low pass filter with an adjustable time constant. It is used to smooth noisy signals. The Damping value is the time required for the output reaching 63.2% for a step input of 100%. This value (in seconds) may be freely configured by the user.

**Factory Characterization**

The actual pressure from the capacitance and temperature readouts obtained from the sensor can be calculated by using the factory characterization data stored in the sensor EEPROM.

**User Linearization**

The characterization TRIM points P1 - P5 can be used to complement the transmitter original characterization.

**Pressure Trim**

The values obtained by Zero Pressure TRIM and Upper Pressure TRIM may correct here the transmitter for long term drift or the shift in zero or upper pressure reading due to installation or over pressure.

**Ranging**

It used to set the pressure values corresponding to the 4 and 20 mA output. In transmitter mode the LOWER-VALUE is the point corresponding to 4 mA, and the UPPER-VALUE is the point corresponding to 20 mA. In PID mode the LOWER-VALUE corresponds to MV = 0% and the UPPER-VALUE corresponds to MV = 100%, where, MV is the Manipulated Variable.

**Function**

Depending on the application, the transmitter output or controller PV may have the following characteristics according to the applied pressure: *Linear* (for pressure, differential pressure and level measurement); *Square-root* (for flow measurement with differential pressure producers) and *Square-root of the Third and Fifth power* (for flow measurements in open channels). The function is selected with FUNCTION.

**Points Table**

This block relates the output (4-20 mA or Process Variable) to the input (applied pressure) according to a look-up table from 2 to 16 points. The output is calculated by the interpolation of these points. The points are given in the function "TABLE POINTS" in percent of the range ( $X_i$ ) and in percent of the output ( $Y_i$ ). It may be used to linearize, e.g., a level measurement to volume or mass. In flow measurement it can be used to correct varying Reynolds numbers.

**Setpoint**

Is the desired value in the process variable when the controller is activated. The operator in the \CONTR\INDIC option adjusts it.

**PID**

First, the error is calculated: PV-SP (DIRECT ACTION) or SP-PV (REVERSE ACTION), then the MV (manipulated value) is calculated, according to the algorithm of the PID. The PID output signal may follow a user-determined curve, in up to 16 configurable points. If the table is enabled, there will be a display indication with the F(X) character

**Auto/Manual**

The Auto/Manual mode is configured in CONTR/INDIC. With the PID in Manual, the MV can be adjusted by the user in the LOW LIMIT to HIGH LIMIT range in the CONTR/LIM-SEG option. The POWER-ON option is used here to determine in which mode the controller should be upon powering it on.

**Limits**

This block makes sure that the MV does not go beyond its minimum and maximum limits as established by the HIGH-LIMIT and LOW-LIMIT. It also makes sure that the Rate-of-Change does not exceed the value set in OUT-CHG/S.

**Output**

It calculates the current proportional to the process variable or manipulated variable to be transmitted on the 4-20 mA output depending on the configuration in OP-MODE. This block also contains the constant current function configured in OUTPUT. The output is physically limited to 3.6 to 21 mA. The current output complies with NAMUR NE-43.

**Current Trim**

The 4 mA TRIM and 20 mA TRIM adjustment is used to make the transmitter current comply with a current standard, should a deviation arise.

**User Unit**

It converts 0 and 100% of the process variable to the desired engineering unit readout available for display and communication. It is used, e.g., to get a volume or flow indication from a level or differential pressure measurement, respectively. A unit for the variable can also be selected.

**Totalization**

Used for flow application to totalize the accumulated flow since the last reset, the last reset, getting the volume or mass transferred. In the lack of power, the totalized value is saved and continues totalizing after its re-establishment.

**Display**

The two indications configured in the DISPLAY alternates between the primary and secondary variable as configured by the user.

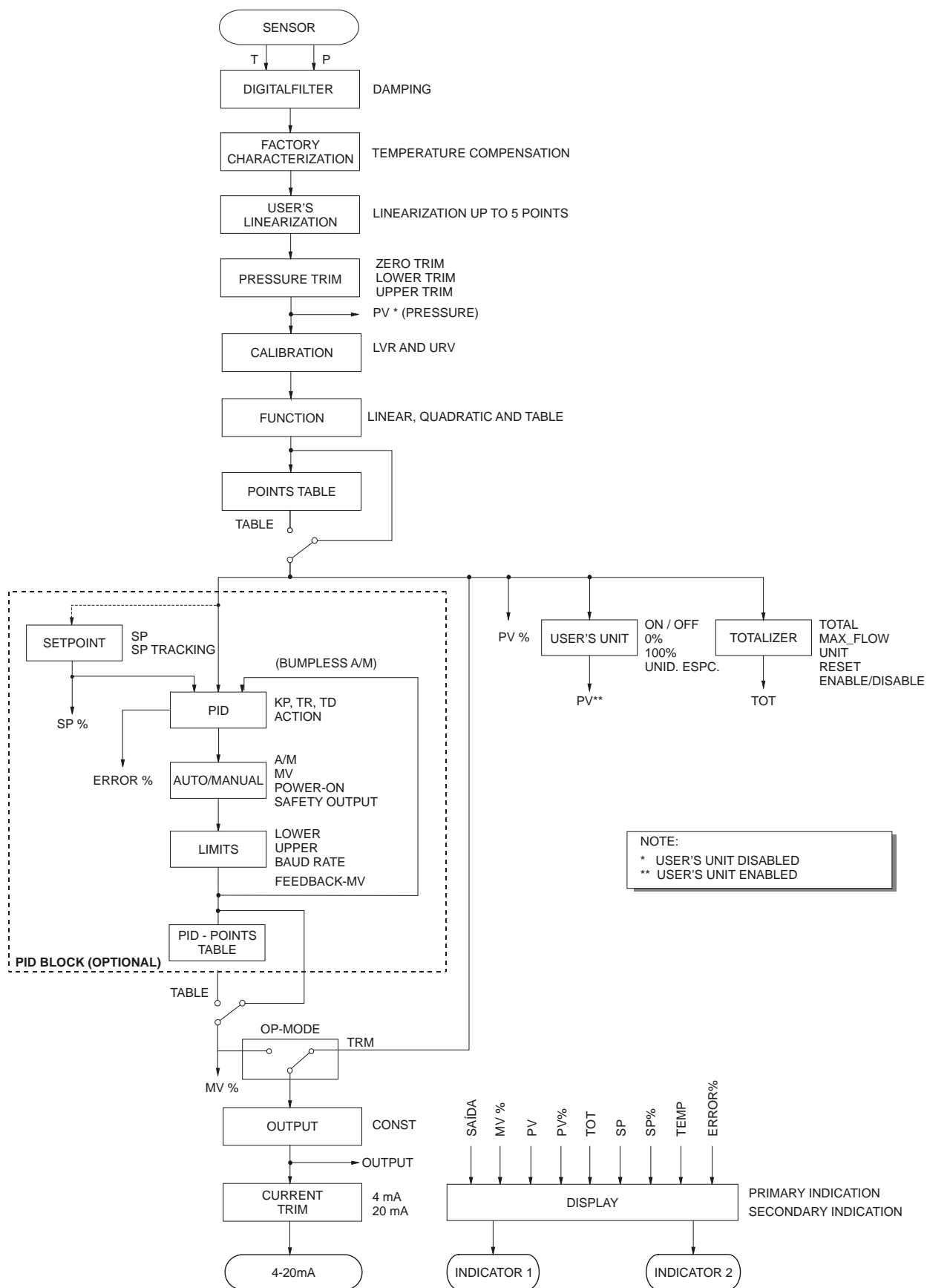

Figure 2.3 – LD301 – Software Block Diagram

## The Display

The local indicator is able to display one or two variables, which are user-selected. When two variables are chosen, the display will alternate between both with an interval of 3 seconds.

The liquid crystal display includes a field with 4 ½ numeric digits, a field with 5 alphanumeric digits and an information field, as shown on Figure 2.4.

When the totalization is displayed, the most significant part appears in the unit and function field (upper) and the least significant part in the variable field (lower). See Total Value in Section 3.

**DISPLAY V6.00**

The display controller, from release V6.00 on is integral part to the main board. Please observe the new spare part codes.

### Monitoring

During normal operation, the **LD301** is in the monitoring mode. In this mode, indication alternates between the primary and the secondary variable as configured by the user. See Figure. 2.5. The display indicates engineering units, values and parameters simultaneously with most status indicators.

The monitoring mode is interrupted when the user does complete local adjustment.

The LCD may also display errors and other messages (See table 2.1).

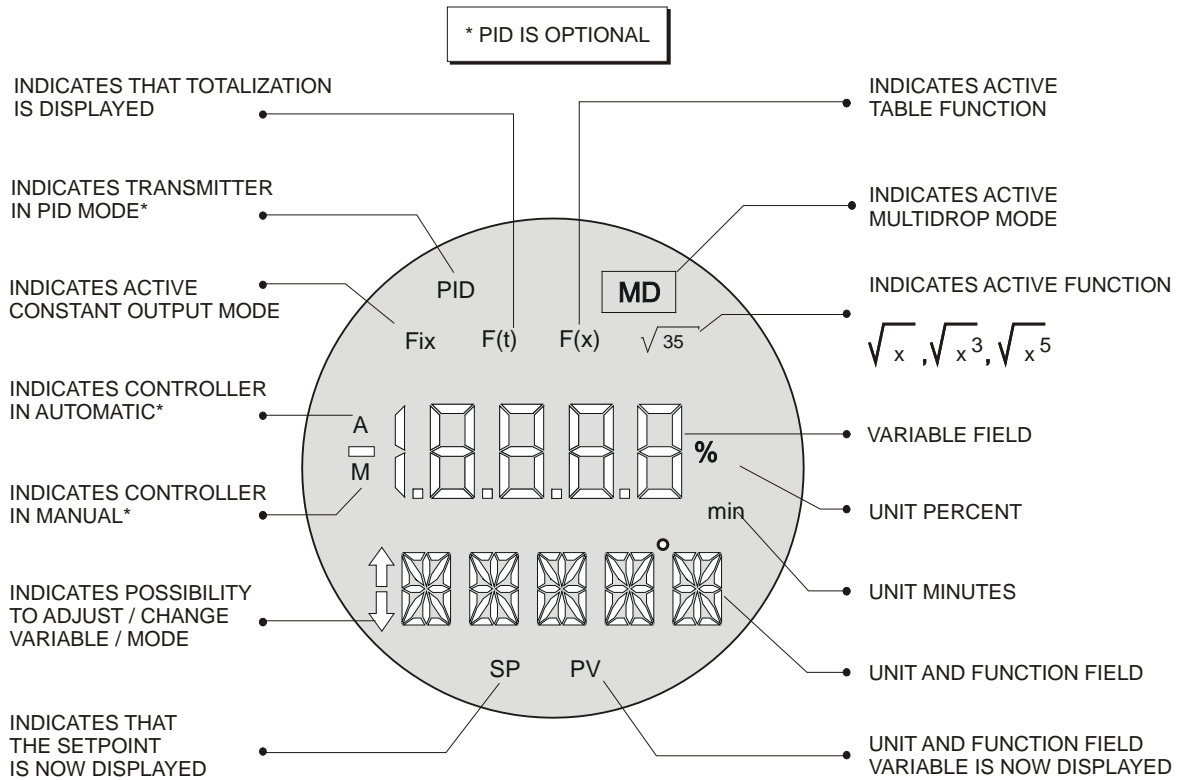
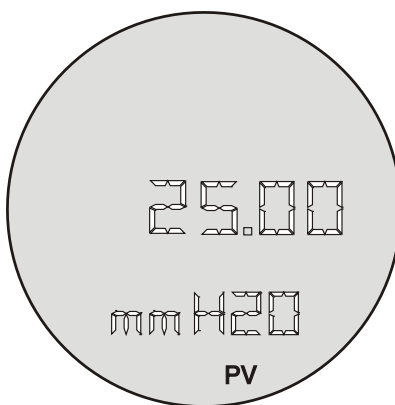

Figure 2.4 – Display



**Figure 2.5 – Typical Monitoring Mode Display Showing PV, in this case 25.00 mmH<sub>2</sub>O**

INDICATOR		DESCRIPTION
Numeric	Alphanumeric	
Version	LD301	The <b>LD301</b> is initialized after feeding.
	CHAR	The <b>LD301</b> is on characterization mode (see Section 3 – TRIM).
Variable Value	SAT / Unit	Output current saturated on 3.8 or 20.5 mA. (see section 5 – Maintenance).
CH / CL alternating with current.	SFAIL / Unit	Failure on one sensor side or on both.
FAIL	Init	Transmitter failed on initialization (sensor memory failure or disconnected).

**Table 2.1 – Messages Displayed**



## CONFIGURATION

The **LD301** Intelligent Pressure Transmitter is a digital instrument with the most up-to-date features a measurement device can possibly have. Its digital communication protocol (HART®) enables the instrument to be connected to a computer in order to be configured in a very simple and complete way. Such computers connected to the transmitters are called HOST computers. They can either be primary or Secondary Masters. Therefore, even the HART® being a master-slave type of protocol, it is possible to work with up to two masters in a bus. The Primary HOST plays the supervisory role and the Secondary HOST plays the Configuration tool role.

The transmitters may be connected in a point-to-point or multidrop type network. In a point-to-point connection, the equipment must be in its "0" address so that the output current may be modulated in 4 to 20 mA, as per the measurement. In a multidrop network, if the devices are recognized by their addresses, the transmitters shall be configured with a network address between "1" and "15". In this case, the transmitter output current is kept constant, with a consumption of 4 mA each. If the acknowledgement mechanism is via Tag, the transmitter addresses may be "0" while their output current is still being controlled, even in a multidrop configuration.

In the case of the **LD301**, which can be configured both as Transmitter and as a Controller; the HART® addressing is used as follows:

**TRANSMITTER MODE** - The "0" address causes the **LD301** to control its output current and addresses "1" through "15" place the **LD301** in the multidrop mode with current control.

**CONTROLLER MODE** - The **LD301** always controls the output current, in accordance with the value calculated for the Controlled Variable, regardless of its network address.

NOTE	
In the case of multidrop network configuration for classified areas, the entity parameters allowed for the area shall be strictly observed. Therefore, the following shall be checked:	
$Ca \geq \sum Ci_j + Cc$	$La \geq \sum Li_j + Lc$
$Voc \leq \min [Vmax_j]$	$Isc \leq \min [Imax_j]$
Where:	
<b>Ca, La</b> - Barrier Allowable Capacitance and Inductance;	
<b>Ci<sub>j</sub>, Li<sub>j</sub></b> - Non protected internal Capacitance/Inductance of transmitter <i>j</i> ( <i>j</i> = up to 15);	
<b>Cc, Lc</b> - Cable capacitance and Inductance;	
<b>V<sub>oc</sub></b> - Barrier open circuit voltage;	
<b>I<sub>sc</sub></b> - Barrier short circuit current;	
<b>Vmax<sub>j</sub></b> - Maximum allowable voltage to be applied to the instrument <i>j</i> ;	
<b>Imax<sub>j</sub></b> - Maximum allowable current to be applied to the instrument <i>j</i>	

The **LD301** Intelligent Pressure Transmitter includes a very encompassing set of HART® Command functions that make it possible to access the functionality of what has been implemented. Such commands comply with the HART® protocol specifications, and are grouped as Overall Commands, Common Practice Controls Commands and Specific Commands. A detailed description of such commands may be found in the manual entitled HART® Command Specification - **LD301** Intelligent Pressure Transmitter.

Smar developed the CONF401 and HPC301 software (See figure 3.2), the first one works in Windows platform (95, 98, 2000, XP and NT) and UNIX. The second one, HPC301, works in the most recent technology in PDA. (See figure 3.1). They provide easy configuration and monitoring of field devices, capability to analyze data and to modify the action of these devices. The operation characteristics and use of each one of the configuration tool are stated on their respective manuals.

Figures 3.1 and 3.2 show the front of the Palm and the CONF401 screen with the active configuration.

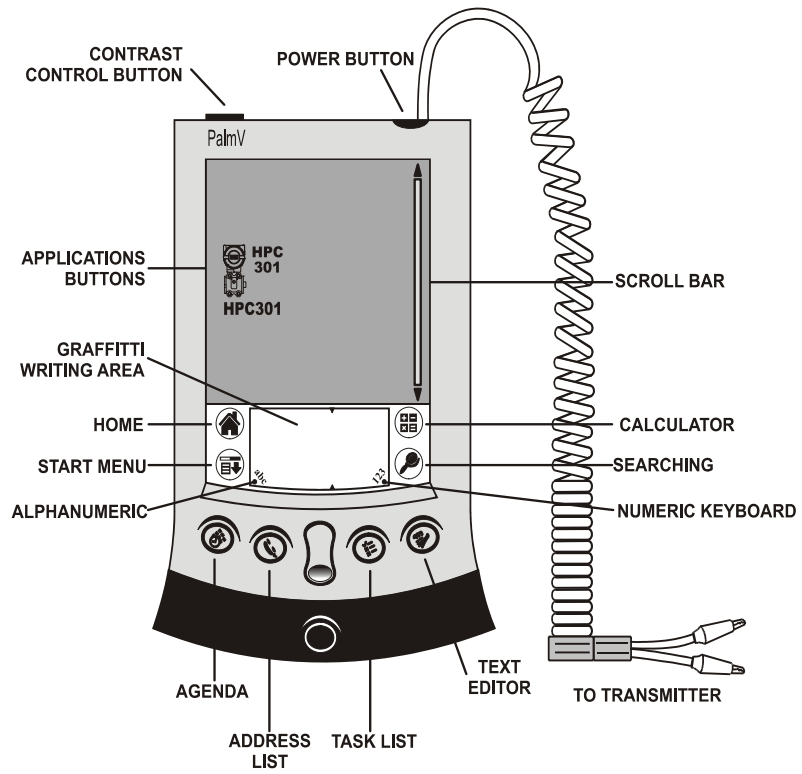

Figure 3.1 – Smar Hand Held Terminal

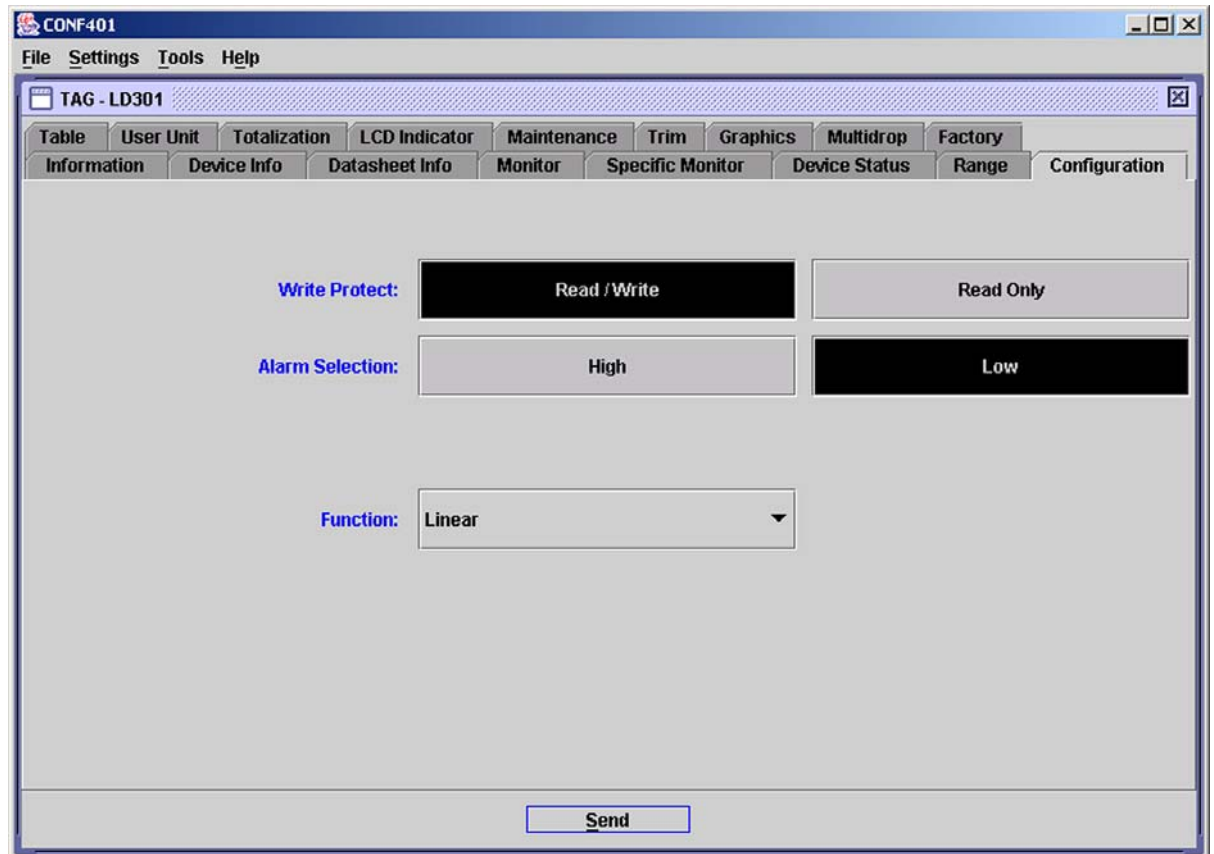

Figure 3.2 – Smar Configuration Tool

Figures 3.3 and 3.4 show the menu tree used for configuration based on version 4.02 DD and configuration with Smar Hand Held Tool, respectively.



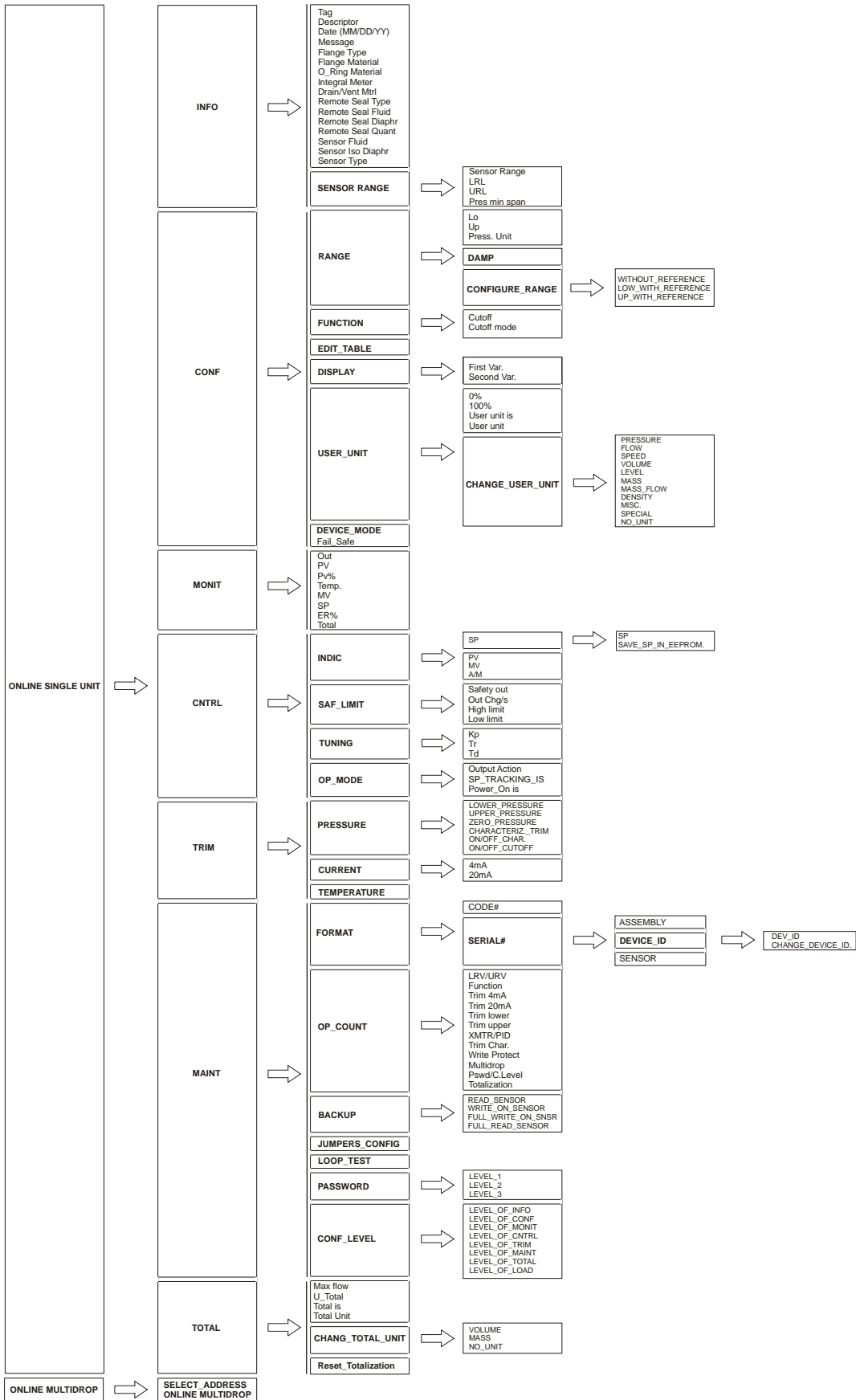

Figure 3.3 –Menu Tree used for Configuration based on Version 4.02 DD

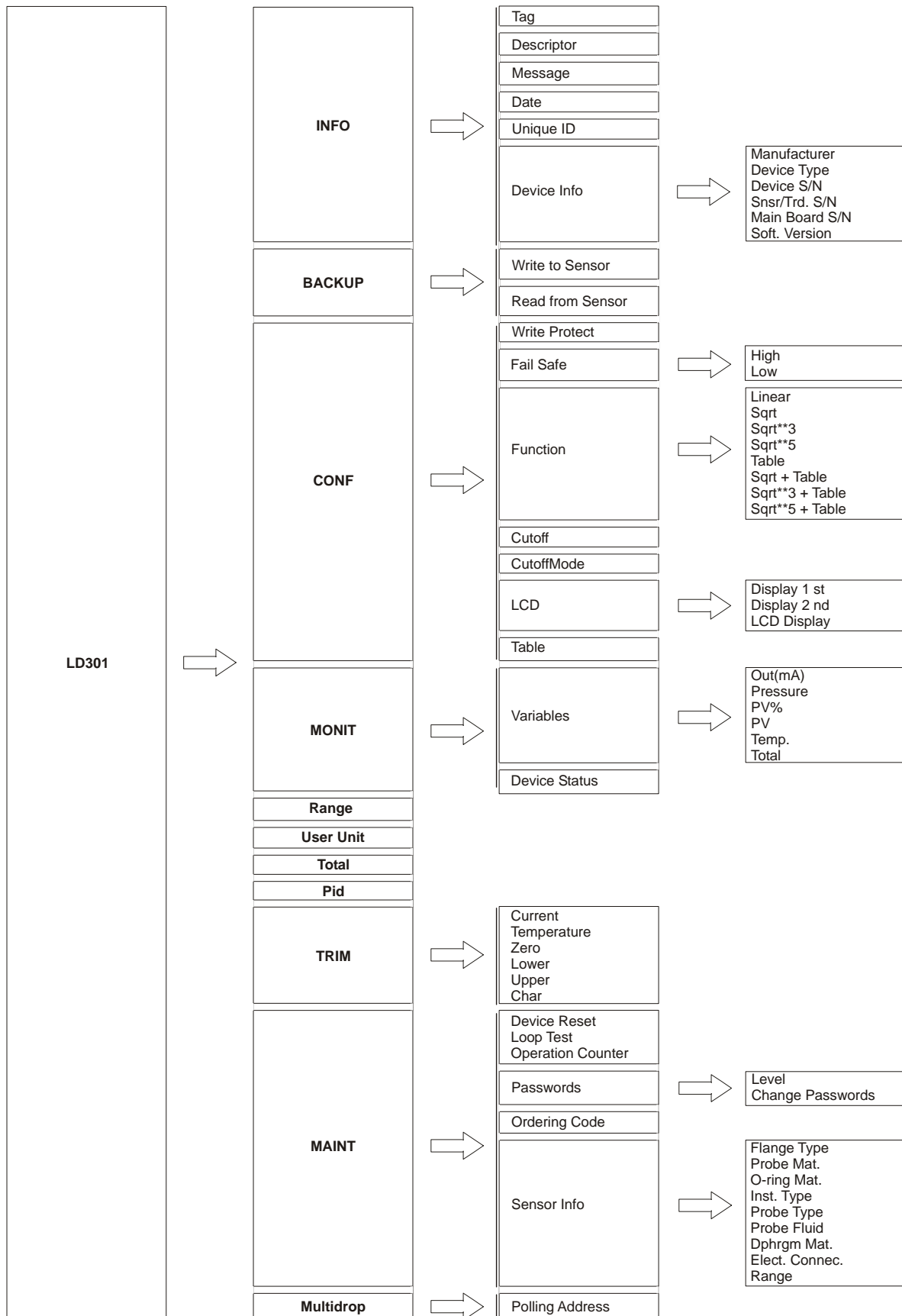

Figure 3.4 – Menu tree used for configuration with Smar Hand Held Tool

## Configuration Features

By means of the HART<sup>®</sup> configuration tool, the **LD301** firmware allows the following configuration features to be accessed:

- ✓ Transmitter Identification and Manufacturing Data;
- ✓ Primary Variable Trim – Pressure;
- ✓ Primary Variable Trim – Current;
- ✓ Transmitter Adjustment to the Working Range;
- ✓ Engineering Unit Selection;
- ✓ Transference Function for Flow rates Measurement;
- ✓ Linearization Table;
- ✓ Totalizer Configuration;
- ✓ PID Controller Configuration and MV% Characterization Table;
- ✓ Device Configuration;
- ✓ Equipment Maintenance.

The operations, which take place between the configuration tool and the transmitter do not interrupt the Pressure measurement, and do not disturb the output signal. The configuration tool can be connected on the same pair of wires as the 4-20 mA signals, up to 2 km away from the transmitter.

## Manufacturing Data and Identification

The following information about the **LD301** manufacturing and identification data is available:

**TAG** – 8 character alphanumeric field for transmitter identification

**DESCRIPTOR** - 16-character alphanumeric field for additional transmitter identification. May be used to identify service or location.

**DATE** - The date may be used to identify a relevant date as the last calibration, the next calibration or the installation. The date is presented in the form of bytes where DD = [1,..31], MM = [1..12], AA = [0..255], where the effective year is calculated by [Year = 1900 + AA].

**MESSAGE** - 32-character alphanumeric field for any other information, such as the name of the person who made the last calibration, some special care to be taken, or if a ladder is needed for accessing.

**FLANGE TYPE** - Conventional, Coplanar, Remote Seal, Level 3 in # 150, Level 4 in # 150, Level 3 in # 300, Level 4 in # 300, Level DN80 PN25/40, Level DN100 PN10/16, Level DN100 PN25/40, Level 2 in # 150, Level 2 in # 300, Level DN50 PN10/16, Level DN50 PN25/40, Level DN80 PN10/16, None, Unknown and Special.

**FLANGE MATERIAL** - Carbon Steel, 316 SST, Hastelloy C, Monel, Unknown, Undefined, Tantalum, None and Special.

**O-RING MATERIAL** - PTFE, Viton, Buna-N, Ethyl-prop, None, Unknown, Undefined and Special.

**INTEGRAL METER** - Installed, None and Unknown.

**DRAIN/VENT MATERIAL** - 316 SST, Hastelloy C, Monel, None, Unknown, Undefined and Special.

**REMOTE SEAL TYPE** - Chemical Tee, Flanged Extended, Pancake, Flanged, Threaded, Sanitary, Sanitary Tank Spud, None, Union Connection, Unknown, Undefined and Special.

**REMOTE SEAL FLUID** - Silicone, Syltherm 800, Inert, Glycerin/H2O, Prop gly/H2O, Neobee-M20, Fluorolube, Undefined, None, Unknown and Special.

**REMOTE SEAL DIAPHRAGM** - 316L SST, Hastelloy C, Tantalum, None, Unknown, Undefined and Special.

**REMOTE SEAL QUANTITY** - One, Two, None, Unknown and Undefined.

**SENSOR FLUID\*** - Silicone, Inert, Special, Unknown and None.

**SENSOR ISOLATING DIAPHRAGM\*** - 316 SST, Hastelloy C, Monel, Tantalum and Special

**SENSOR TYPE\*** - It shows the sensor type.

**SENSOR RANGE\*** - It shows the sensor range in user-chosen engineering units. See Configuration Unit.

### NOTE

Items marked with asterisk cannot be changed. They come directly from the sensor memory.

## Primary Variable Trim - Pressure

Pressure, defined as a Primary Variable, is determined from the sensor readout by means of a conversion method. Such a method uses parameters obtained during the fabrication process. They depend on the electric and mechanical characteristics of the sensor, and on the temperature change to which the sensor is submitted. These parameters are recorded in the sensor's EEPROM memory. When the sensor is connected to the transmitter, such information is made available to the transmitter microprocessor, which sets a relationship between the sensor signal and the measured pressure.

Sometimes, the pressure shown on the transmitter display is different from the applied pressure. This may be due to several reasons, among which the following:

The transmitter mounting position;

- ✓ The user pressure standard differs from the factory standard;
- ✓ Sensor original characteristics shifted by overpressure, over temperature or by long-term drift.

### NOTE

Some users prefer to use this feature for zero elevation or suppression when the measurement refers to a certain point of the tank or tap (wet leg). Such practice, however, is not recommended when frequent laboratory calibrations are required, because the equipment adjustment refers to a relative measurement, and not to an absolute one, as per a specific pressure standard.

The Pressure Trim, as described on this document, is the method used in order to adjust the measurement both in relation to the applied pressure and the user's pressure standard. The most common discrepancy found in transmitters is usually due to Zero displacement. This may be corrected by means of the zero trim or the lower trim.

There are four types of pressure trim available:

- ✓ **LOWER TRIM:** Is used to trim the reading at the lower range. The user informs the transmitter the correct reading for the applied pressure via HART® configuration tool.

### NOTE

Check on section 1, the note on the influence of the mounting position on the indicator. For better accuracy, the trim adjustment should be made in the lower and upper values of the operation range values.

- ✓ **UPPER TRIM:** Is used to trim the reading at the upper range. The user informs the transmitter the correct reading for the applied pressure via HART® configuration tool.

### WARNING

The upper pressure trim shall always be applied after the zero trim.

- ✓ **ZERO TRIM:** is similar to the LOWER TRIM, but is assumed that the applied pressure is zero. The reading equal to zero must be active when the pressures of differential transmitter cameras are equalized or when a gage transmitter opens to atmosphere or when the absolute transmitter is applied to the vacuum. Therefore, the user does not need to enter with any value.

### NOTE

The pressure taps on the transmitter must be equalized when zero trim is applied.

- ✓ **CHARACTERIZATION:** this is used to correct any possible intrinsic non-linearity to the conversion process. Characterization is done by means of a linearization table, with up to five points. The user shall apply pressure and use the HART® configuration tools to inform the pressure value applied to each point of the table. In most cases, characterization is not required, due to the efficiency of the production process. The transmitter will display "CHAR", thus indicating that the characterization process has been activated. The LD301 is fitted with an internal feature to enable or disable the use of the Characterization Table.

### WARNING

*The characterization trim changes the transmitter characteristics. Read the instructions carefully and make sure that you are working with a pressure standard with 0.03% accuracy or better, otherwise the transmitter accuracy will be seriously affected.*

## Primary Variable Current Trim

When the microprocessor generates a 0% signal, the Digital to Analog converter and associated electronics are supposed to deliver a 4 mA output. If the signal is 100%, the output should be 20 mA.

There might be differences between the Smar current standards and your current plant Standard. In this case, the Current Trim adjustment shall be done with a precision ammeter as measurement reference. Two Current Trim types are available:

- ✓ **4 mA TRIM:** this is used to adjust the output current value corresponding to **0%** of the measurement;
- ✓ **20 mA TRIM:** this is used to adjust the output current value corresponding to **100%** of the measurement;

The Current Trim shall be carried out as per the following procedure:

- ✓ Connect the transmitter to the precision ammeter;
- ✓ Select one of the Trim types;
- ✓ Wait a while for the current to stabilize and inform the transmitter the current readout of the precision ammeter.

### NOTE

The transmitter presents a resolution that makes it possible to control currents as low as microamperes. Therefore, when informing the current readout to the transmitter, it is recommended that data input consider values up to tenths of microamperes.

## Transmitter Adjustment to the Working Range

This function directly affects the transmitter 4-20 mA output. It is used to define the transmitter working range; in this document it is referred to as the transmitter calibration. The **LD301** transmitter includes two calibration features:

- ✓ **CALIBRATION WITH REFERENCE:** this is used to adjust the transmitter working range, using a pressure standard as reference;
- ✓ **CALIBRATION WITHOUT REFERENCE:** this is used to adjust the transmitter working range, simply by having user-informed limit values.

Both calibration methods define the Working Range Upper and Lower values, in reference to some applied pressure or simply informed by entered values. **CALIBRATION WITH REFERENCE** differs from the Pressure Trim, since **CALIBRATION WITH REFERENCE** establishes a relationship between the applied pressure and the 4 to 20 mA signal, and the Pressure Trim is used to correct the measurement.

In the transmitter mode, the Lower Value always corresponds to 4 mA and the Upper Value to 20 mA. In the controller mode, the Lower Value corresponds to PV=0% and the Upper Value to PV=100%.

The calibration process calculates the LOWER and the UPPER values in a completely independent way. The adjustment of values does not affect one another. The following rules shall, however, be observed:

- ✓ The Lower and Upper values shall be within the range limited by the Minimum and Maximum Ranges supported by the transmitter. As a tolerance, values exceeding such limits by up to 24% are accepted, although with some accuracy degradation;
- ✓ The Working Range Span, determined by the difference between the Upper and Lower Values, shall be greater than the minimum span, defined by [Transmitter Range / (120) for models: D, M, H, A4, A5, and Transmitter Range / (2,5), (25), or (50) for A1, A2, and A3, respectively]. Values up to 0.75 of the minimum span are acceptable with slight accuracy degradation.

### NOTE

Should the transmitter operate with a very small span, it will be extremely sensitive to pressure variations. Keep in mind that the gain will be very high and that any pressure change, no matter how small, will be amplified.

If it is necessary to perform a reverse calibration, that is, to work with an UPPER VALUE smaller than the LOWER VALUE, proceed as follows:

- ✓ Place the Lower Limit in a value as far as possible from the present Upper Value and from the new adjusted Upper value, observing the minimum span allowed. Adjust the Upper Value at the desired point and, then, adjust the Lower Value.

This type of calibration is intended to prevent the calibration from reaching, at any moment, values not compatible with the range. For example: lower value equals to upper value or separated by a value smaller than the minimum span.

This calibration procedure is also recommended for zero suppression or elevation in those cases where the instrument installation results in a residual measurement in relation to a certain reference. This is the specific case of the wetted tap.

NOTE
In most applications with wetted taps, indication is usually expressed as a percentage. Should readout in engineering units with zero suppression be required, it is recommended to use the User Unit feature for such conversion.

## Engineering Unit Selection

Transmitter **LD301** includes a selection of engineering units to be used in measurement indication.

For pressure measurements, the **LD301** includes an option list with the most common units. The internal reference unit is inH<sub>2</sub>O @ 20 °C; should the desired unit be other than this one, it will be automatically converted using conversion factors included in Table 3.1.

As the **LD301** uses a 4 ½ digit display, the largest indication will be 19999. Therefore, when selecting a unit, make sure that it will not require readouts greater than this limit. For User reference, Table 3.1 presents a list of recommended sensor ranges for each available unit.

CONVERSION FACTOR	NEW UNITS	RECOMMEND RANGE
1,00000	inH <sub>2</sub> O @ 20 °C	1, 2, 3 and 4
0,0734241	inHg @ 0 °C	all
0,0833333	ftH <sub>2</sub> O @ 20 °C	all
25,4000	mmH <sub>2</sub> O @ 20 °C	1 and 2
1,86497	mmHg @ 0 °C	1, 2, 3 and 4
0,0360625	psi	2, 3, 4, 5 and 6
0,00248642	bar	3, 4, 5 and 6
2,48642	mbar	1, 2, 3 and 4
2,53545	gf/cm <sup>2</sup>	1, 2, 3 and 4
0,00253545	kg/cm <sup>2</sup>	3, 4, 5 and 6
248,642	Pa	1
0,248642	kPa	1, 2, 3 and 4
1,86947	Torr @ 0 °C	1, 2, 3 and 4
0,00245391	atm	3, 4, 5 and 6
0,000248642	MPa	4, 5 and 6
0,998205	inH <sub>2</sub> O @ 4 °C	1, 2, 3 and 4
25,3545	mmH <sub>2</sub> O @ 4 °C	1 and 2
0,0254	mH <sub>2</sub> O @ 20 °C	1, 2, 3 and 4
0,0253545	mH <sub>2</sub> O @ 4 °C	1, 2, 3 and 4

**Table 3.1 – Available Pressure Units**

In applications where the **LD301** will be used to measure variables other than pressure or in the cases where a relative adjustment has been selected, the new unit may be displayed by means of the User Unit feature. This is the case of measurements such as level, volume, and flow rate or mass flow obtained indirectly from pressure measurements.

The User Unit is calculated adopting the working range limits as a reference, which is, defining a value corresponding to 0% and another corresponding to 100% of the measurement:

- ✓ **0%** - Desired readout when the pressure is equal to the Lower Value (PV% = 0%, or transmitter mode output equal to 4 mA);
- ✓ **100%** - Desired readout when the pressure is equal to the Upper Value (PV% = 100%, or transmitter mode output equal to 20 mA).

The user unit may be selected from a list of options included in the **LD301**. Table 3.2 makes it possible to associate the new measurement to the new unit so that all supervisory systems fitted the HART® protocol can access the special unit included in this table. The user will be responsible for the consistency of such information. The **LD301** does not verify if the values corresponding to the 0% and 100% inserted by the user are compatible with the selected unit.

VARIABLE	UNITS
Pressure	inH <sub>2</sub> O, inHg, ftH <sub>2</sub> O, mmH <sub>2</sub> O, mmHg, psi, bar, mbar, gf/cm <sup>2</sup> , kgf/cm <sup>2</sup> , Pascal, Torriceli, atm, Mpa, inH <sub>2</sub> O @ 4 °C, mmH <sub>2</sub> O @ 4 °C, mH <sub>2</sub> O, mH <sub>2</sub> O @ 4 °C.
Volumetric Flow	ft <sup>3</sup> /m, gal/mim, min, Gal/m, m <sup>3</sup> /h, gal/s, l/s, Ml/d, ft <sup>3</sup> /d, m <sup>3</sup> /s, m/d, Ga/h, Ga/d, ft <sup>3</sup> /h, m <sup>3</sup> /min, bbl/s, bbl/min, bbl/d, gal/s, l/h, gal/d.
Velocity	ft/s, m/s, m/h.
Volume	gal, litro, Gal, m <sup>3</sup> , bbl, bush, Yd <sup>3</sup> , Pé <sup>3</sup> , In <sup>3</sup> , hl.
Level	ft, m, in, cm, mm.
Mass	grama, kg, Ton, lb, Sh ton, Lton.
Mass Flow	g/s, g/min, g/h, kg/s, kg/m, kg/h, kg/d, Ton/m, Ton/h, Ton/d, lb/s, lb/m, lb/h, lb/d
Density	SGU, g/m <sup>3</sup> , kg/m <sup>3</sup> , g/ml, kg/l, Twad, Brix, Baum L, API, % Solw, % Solv, Ball.
Others	CSo, cPo, mA, %.
special	5 caracteres. (See HART® Special Units in section 5).

**Table 3.2 – Available User Units**

Should a special unit other than those presented on Table 3.2 be required, the **LD301** allows the user to create a new unit by entering up to 5 alphanumeric digits. The **LD301** includes an internal feature to enable and disable the User Unit.

**Example:** transmitter **LD301** is connected to a horizontal cylindrical tank (6 meters long and 2 meters in diameter), linearized for volume measurement using camber table data in its linearization table. Measurement is done at the high-pressure tap and the transmitter is located 250 mm below the support base. The fluid to be measured is water at 20 °C. Tank volume is:  $[(\pi \cdot d^2)/4] \cdot l = [(\pi \cdot 2^2)/4] \pi \cdot 6 = 18.85 \text{ m}^3$ . The wet tap shall be subtracted from the measured pressure in order to obtain the tank level. Therefore, a calibration without reference shall be carried out, as follows:

**In Calibration:**

Lower = 250 mmH<sub>2</sub>O  
 Upper = 2250 mmH<sub>2</sub>O  
 Pressure unit = mmH<sub>2</sub>O

**In User Unit:**

User Unit 0% = 0  
 User Unit 100% = 18.85 m<sup>3</sup>  
 User Unit = m<sup>3</sup>

When activating the User's Unit, **LD301** it will start to indicate the new measurement.

## Transfer Function for Flow Measurement

The function can be used to linearize the measured pressure to flow or volume. The following functions are available:

NOTE
<ul style="list-style-type: none"> <li>• Use the lowest required damping to prevent measurement delays;</li> <li>• If the square root extraction for flow measurement is carried out externally by other loop element, do not enable this function on the transmitter</li> </ul>

**SQRT** - Square Root. Considering the pressure input **X** varying between 0 and 100%, the output will be  $10\sqrt{x}$ . This function is used in flow measurement with, e.g., orifice or Venturi tube etc.

The Square Root has an adjustable cutoff point. Below this point the output is linear, if the cutoff mode is bumpless with the differential pressure as indicated by the Figure 3.5. If the cutoff mode is hard the output will be 0% below the cutoff point. The default value for Cutoff is 6% of ranged pressure input. The maximum value for cutoff is 100%. Cutoff is used to limit the high gain, which results from square root extraction on small values. This gives a more stable reading at low flows.

In order to find the square root, the **LD301** configurable parameters are: cutoff point defined at a certain pressure expressed as % and the cutoff mode, hard or bumpless.

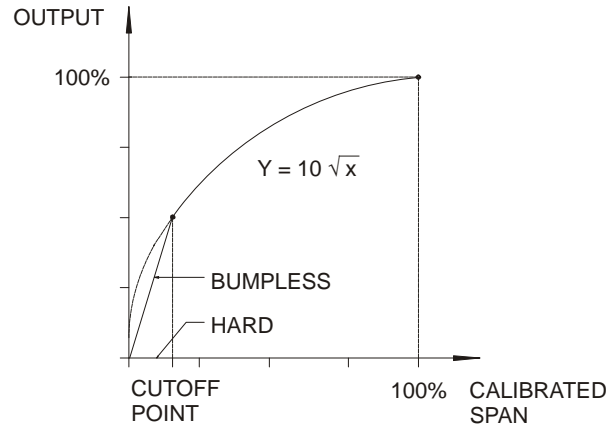

Figure 3.5 – Square Root curve with Cutoff point

**NOTE**

In bumpless cutoff mode the gain below the cutoff point is given by the equation:

$$G = \frac{10}{\sqrt{\text{cutoff}}}$$

For example, at 1% the gain is 10, i.e., a 0.1% error in differential pressure, gives a 1% error in Flow reading. The lower the cutoff, the higher is the gain.

The measurement of the bidirectional flow is useful when it is needed to measure the flow in the pipe in both directions. For example, in tank maneuvering there are several pipes where the direction of the fluid may vary. In this case, **LD301** has the bidirectional flow measurement function. This function treats the flow, no matter what its direction is, as if it were positive. Thus, it is possible to extract the square root and measure the bidirectional flow.

- ✓ **SQRT\*\*3** - Square Root of the Third Power;  
The output will be  $0.1\sqrt{x^3}$ . This function is used in open channel Flow measurement with weirs or flumes.
- ✓ **SQRT\*\*5** - Square Root of the Fifth Power. The output will be  $0.001\sqrt{x^5}$ . This function is used in open channel Flow measurement with V-notch weirs.

It is possible to combine the previous functions with a table. The flow can be corrected according to the table to compensate, for example, the variation of Reynolds number at the flow measurement.

- ✓ **TABLE** - The output is a curve formed by 16 points. These points may be edited directly on the XY Table of the **LD301**. For example, it may be used as a camber table for tanks in applications where the tank volume is not linear in relation to the measured pressure;
- ✓ **SQRT & TABLE** - Square root and Table. Same application as square roots, but also allows additional compensation of, e.g., varying Reynolds number.
- ✓ **SQRT\*\*3 & TABLE** - Square Root of the Third Power AND TABLE;
- ✓ **SQRT\*\*5 & TABLE** - Square Root of the Fifth Power AND TABLE.
- ✓ **TABLE & SQRT** – This function provides bidirectional flow measurement (piping flow measurement in both ways). This function is available for version 6.05 or above firmware.

**Example:**

There is a flow on the positive direction (high pressure on the H side) with a 0 to 400 mbar DP and a flow on the negative direction (high pressure on the L side) from 0 to 100 mbar. For these data make the range lower value equal to -100 mbar, complete the table below, and always including the 0 per cent pressure value, namely 20 per cent. Insert the data on the transmitter.



X	Y
0 % (-100 mbar)	100 %
20 % (0 mbar)	0 %
100 % (400 mbar)	100 %

**NOTE**

To configure a symmetrical bidirectional flow double the number of calibration points to get a better performance.

Next, configure the cutting point. Refer to the previous Root item.

## Table Points

If the option TABLE is selected, the output will follow a curve given in the option TABLE POINTS. If the user wants to have your 4-20 mA proportional to the fluid volume or mass inside a tank, he must transform the pressure measurement "X" into volume (or mass) "Y" using the tank strapping table, as the example shown in Table 3.3.

POINTS	LEVEL (PRESSURE)	X	VOLUME	Y
1	-	-10 %	-	-0.62 %
2	250 mmH <sub>2</sub> O	0 %	0 m <sup>3</sup>	0 %
3	450 mmH <sub>2</sub> O	10 %	0.98 m <sup>3</sup>	5.22 %
4	750 mmH <sub>2</sub> O	25 %	2.90 m <sup>3</sup>	15.38 %
5	957.2 mmH <sub>2</sub> O	35.36 %	4.71 m <sup>3</sup>	25 %
6	1050 mmH <sub>2</sub> O	40 %	7.04 m <sup>3</sup>	37.36 %
7	1150 mmH <sub>2</sub> O	45 %	8.23 m <sup>3</sup>	43.65 %
8	1250 mmH <sub>2</sub> O	50 %	9.42 m <sup>3</sup>	50 %
:	:	:	:	:
15	2250 mmH <sub>2</sub> O	100 %	18.85 m <sup>3</sup>	100 %
16	-	110 %	-	106 %

**Table 3.3 - Tank Strapping Table**

As shown on the previous example, the points may be freely distributed for any desired value of X. In order to achieve a better linearization, the distribution should be concentrated in the less linear parts of the measurement.

The **LD301** includes an internal feature to enable and disable the Linearization Table.

## Totalization Configuration

When the **LD301** works in flow applications it is often desirable to totalize the flow in order to know the accumulated volume or mass that has flown through the pipe/channel.

The totalizer integrates the PV% along time, working with a time scheduling based on seconds, as per the following formula:

$$TOT = \int \frac{MAXIMUM FLOWRATE}{TOTALIZATION INCREMENT} PV\% dt$$

The method uses such totalization and, through three parameters (MAXIMUM FLOWRATE, TOTAL INCREMENT and TOTAL UNIT), converts it to the user-defined totalizing unit:

- ✓ **MAXIMUM FLOW RATE** - this is the maximum flow rate expressed in volume or mass units per second, corresponding to the measurement (PV%=100%). For example: m<sup>3</sup>/s, bbl/s, kg/s, lb/s;

- ✓ **TOTALIZATION INCREMENT** - this is used to convert the flow rate base unit into a multiple unit of mass or volume. For example, a flow rate totalized in gallons/s may be converted to a volume in m<sup>3</sup>; a mass flow rate of g/s may be converted to kilos, etc.
- ✓ **TOTALIZATION UNIT** - this is the engineering unit. It shall be associated to the totalized value. It may be a standard unit or a special unit with up to five characters.

**WARNING**

The totalizer shall be disabled so that any of these parameters can be configured.

The largest totalized value is 99.999.999 totalizing units. When the totalization is displayed, the most significant part is shown on the numeric field, and the less significant part is shown on the alphanumeric field. Figure 3.6 shows a typical display indication.

**NOTE**

F(t) indication is activated every time the totalized value is shown on the digital display.

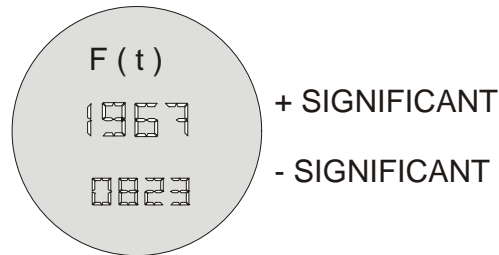

**Figure 3.6 – Typical Monitoring Mode Display Showing the Total, in this case 19.6708.23**

The following services are associated with the Totalizer:

- ✓ **INITIALIZATION** - Totalization is reinitialized from value "0";
- ✓ **ENABLING / DISABLING** - this allows the totalization function to be enabled or disabled.

**WARNING**

From Version V6.00 on, with the use of the new main board, the totalized value is persistent, i.e., there is no longer the risk of losing this information in case of power failure.

**Example:** A differential pressure of 0 - 20 inH<sub>2</sub>O represents a flow of 0 - 6800 dm<sup>3</sup>/minute.

In CONF set Lower = 0 inH<sub>2</sub>O and Upper = 20 inH<sub>2</sub>O.

In order to adjust the MAX.\_FLOW, the maximum flow must be converted to cubic decimeters per second: 6800 / 60 = 113.3 dm<sup>3</sup> /s.

The selection of the totalization unit (U\_TOTAL) is made in function of the maximum flow and the minimum time allowable for the counter overrun, i.e., the time required for the totalization to reach 99.999.999.

In the example, if U\_TOTAL = 1, the totalization increment is 1 dm<sup>3</sup>. The time required for the overrun with maximum flow is 245 hours, 10 minutes and 12.5 seconds.

On the other hand, in case a TOTALIZATION INCREMENT equal to 10 is used, the totalized unit will be deciliter (dal) and the totalizer will receive one increment at every 10 dm<sup>3</sup>. Considering the maximum flow rate (113.3 dm<sup>3</sup>/s), the totalizer will reach its maximum value and return to zero in 102 days, 3 hours, 42 minutes and 5.243 seconds.

## PID Controller Configuration

The **LD301** may be factory -configured to work as Transmitter only or as Transmitter / Controller. In case the **LD301** is configured as a Transmitter / Controller, the end user may change its operation mode at any time simply by configuring an internal status variable.

As a PID Controller, the **LD301** may run a PID type control algorithm, where its 4 to 20 mA will represent the status of the Manipulated variable (MV). In such a mode, output is 4 mA when the MV = 0% and 20 mA when MV= 100%.

The PID implementation algorithm is:

$$MV = K_p (e + 1/Tr \int e dt + T_d dPV/dt)$$

Where:

- e(t)** = PV-SP (direct) SP-PV (reverse)
- SP** = Setpoint
- PV** = Process Variable (Pressure, Level, Flow, etc.)
- Kp** = Proportional Gain
- Tr** = Integration Time
- Td** = Derivative Time
- MV** = Manipulated Variable (output)

The three configuration groups below are pertinent to the PID controller:

- ✓ **SAFETY LIMITS** - this group enables the configuration of: Safety Output, Output Rate and Output Lower and Upper Limits.  
 The Safety Output defines the value of the output in the case of equipment failure.  
 Output Rate is the maximum variation Rate allowed for the output, expressed in %/s.  
 The Lower and Upper Limits define the output range.
- ✓ **TUNING** - this group enables the PID tuning to be performed. The following parameters may be adjusted: Kp, Tr and Td.  
 Parameter Kp is the proportional gain (not the proportional band) that controls the PID proportional action. It may be adjusted from 0 to 100.  
 Parameter Tr is the integral time that controls the PID integral action. It may be adjusted from 0 to 999 minutes per repetition.  
 Parameter Td is the derivative time controlling the PID derivative action. It may be adjusted from 0 to 999 seconds.

**NOTE**

All these parameters accept zero as input. Such value simply nullifies the corresponding PID control actions.

- ✓ **OPERATION MODES** - this group enables the configuration of: Control Action, Setpoint Tracking and Power On.  
 The Control Action Mode enables the selection of the desired output action: direct or reverse. In direct action, a PV increase causes an output increase; in reverse action, a PV increase causes an output decrease.  
 When the Setpoint Tracking mode is enabled, it is possible for the Setpoint to follow the PV while in Manual Control. Thus, when control passes to Auto, the Setpoint value will be that of the last PV prior to the switching.  
 When the PID is enabled, the Power On mode allows the adjustment of the mode in which the PID controls shall return after a power failure: Manual mode, Automatic mode or the last mode prior to the power failure.
- ✓ **TABLE** – If the table option is selected, the MV output will follow a curve according to the values typed in the **LD301**'s characterization table. The points can freely be configured as percentage values. For a better linearization, it is recommendable that the points are the closest possible, in the less linear regions of the curve. The **LD301** has an internal variable to enable and disable the characterization table of the MV output of the PID.

## Equipment Configuration

The **LD301** enables the configuration not only of its operational services, but of the instrument itself. This group includes services related to: Input Filter, Burnout, Addressing, Display Indication, Writing Protection and Passwords.

- ✓ **INPUT FILTER** - The Input Filter, also referenced to as damping, is a first class digital filter implemented by the firmware. User configurable from any value higher than zero seconds in addition to intrinsic sensor response time (0.2 s) (via digital communication). The transmitter mechanical damping is 0.2 seconds.

- ✓ **BURN OUT** - The output current may be programmed to go to the maximum limit of 21 mA (Full Scale) or to the minimum limit of 3.6 mA in case of transmitter failure. Configuring the BURNOUT parameter for Upper or Lower may do this.

The BURNOUT configuration is only valid in the transmitter mode. When a failure occurs in the PID mode, the output is driven to a safety Output value, between 3.8 and 20.5 mA.

- ✓ **ADDRESSING** - The LD301 includes a variable to define the equipment address in a HART® network. Addresses may go from value "0" to "15"; addresses from "1" to "15" are specific addresses for multidrop connections. This means that, in a multidrop configuration, the LD301 will display the message MDROP for addresses "1" to "15".

NOTE
The output current will be increased to 4 mA as the LD301 address, in the Transmitter mode, is altered to another value than "0" (this does not happen when the LD301 is configured in the Controller mode).

The LD301 is factory-configured with address "0".

- ✓ **DISPLAY INDICATION** - the LD301 digital display is comprised of three distinct fields: an information field with icons indicating the active configuration status, a 4 ½ digit numeric field for value indication and a 5 digit alphanumeric field for units and status information.

The LD301 may work with up to two display configurations to be alternately displayed at 3 second intervals. Parameters that may be selected for visualization are those listed on Table 3.4, below.

PARAMETER	DESCRIPTION
<b>CURRENT</b>	Current in mille amperes.
<b>PV%</b>	Process Variable in percentage.
<b>PV</b>	Process Variable in engineering units.
<b>MV% (*)</b>	Output in percentage.
<b>PR</b>	Pressure in pressure unit.
<b>TEMP</b>	Ambient temperature.
<b>TOTAL</b>	Total accumulated by the totalizer.
<b>SP% (*)</b>	Setpoint in percentage.
<b>SP (*)</b>	Setpoint in engineering units.
<b>ER% (*)</b>	Error in percentage (PV% - SP %).
<b>NONE</b>	Used to cancel the second indication.

**Table 3.4 – Variables for Display Indication**

NOTE
Items marked with an asterisk can only be selected in the PID mode. Total can only be selected if enabled.

- ✓ **WRITING PROTECTION** - This feature is used to protect the transmitter configuration from changes via communication. All configuration data are writing-protected.

The LD301 includes two write protection mechanisms: software and hardware locking; software locking has higher priority.

When the LD301 writing software protection mechanism is enabled, it is possible, by means of specific commands, to enable or disable the write protection.

- ✓ **PASSWORDS** - this service enables the user to modify the operation passwords used in the LD301. Each password defines the access for a priority level (1 to 3); such configuration is stored in the LD301 EEPROM. Password Level 3 is hierarchically superior to password level 2, which is superior to level 1. The levels 1 and 2 are available for external access allowing configurator to create its proper access structure.

## Equipment Maintenance

Here are grouped maintenance services related with the collection of information required for equipment maintenance. The following services are available: Order Code, Serial Number, Operation Counter and Backup/Restore.

- ✓ **ORDER CODE** - The Order Code is the one used for purchasing the equipment, in accordance with the User specification. There are 26 characters available in the **LD301** to define this code.

**EXAMPLE:**

1	2	3	4	5	6	7	8	9	10	11	12	13	14	15	16	17	18	19	20	21	22	23	24	25	26	
LD301	D2	1	0	H	1	I	B	U	0	0	P	0	1	0	I	1	A	0	1	0	/	BU	Y2	Y5	P2	F1

#	OPTION	DESCRIPTION
1	LD301	Differential, Flow, and Level Transmitter.
2	D2	Differential, Range: -50 a 50 kPa.
3	1	Stainless Steel 316L Diaphragm and Fill Fluid with Silicone Oil.
4	0	Class of Standard performance.
5	H	HART® Transmitter 4-20 mA.
6	1	SIS: Safety Integrity System.
7	I	Flanges, Adapters, and 316 Stainless steal Drain/Vent valves.
8	B	Buna N O-Rings.
9	U	Drain in up position.
10	0	Process Connection: 1/4 - 18 NPT (Without Adapter).
11	0	Without Special Cleaning.
12	P	Flanges, nuts, and bolts Material: Plated Carbon Steel.
13	0	Flange Threaded for accessories fixing (adapters, manifolds, etc): 7/16" UNF.
14	2	With Digital Indicator.
15	0	Electrical connection 1/2 NPT.
16	I	316 Blank conduit Plug.
17	1	316 Stainless Steel Blank conduit Plug. Mounting Bracket for 2" Pipe or surface mounting: Bracket and Accessories in Carbon Steel.
18	A	Electronic Housing: Aluminum.
19	0	Painting: N6, 5 Munsell Gray Polyester.
20	1	Identification plate: FM: XP, IS, NI, DI, IP.
21	0	TAG plate: with tag, when specified.
22	BU	Burn-out: full Scale.
23	Y2	LCD1 Indication: Pressure (Engineering Units).
24	Y5	LCD2 Indication: Temperature (Engineering Units).
25	P2	Available and enable PID.
26	F1	Transfer Function for flow measure: Square Root.

**Table 3.5 – Differential Pressure Transmitter Ordering Code**

- ✓ **SERIAL NUMBER** - Three serial numbers are stored:
  - Circuit Number** - This number is unique to each main circuit board and cannot be changed.
  - Sensor Number** - The serial number of the sensor connected to the **LD301** and cannot be changed. This number is read from the sensor every time a new sensor is inserted in the main board.
  - Transmitter Number** - the number that is written at the identification plate in each transmitter.

NOTE
The transmitter number must be changed whenever there is the main plate change to avoid communication problems.

- ✓ **OP\_COUNT** - Every time a change is made, there is an increment in the respective change counter for each monitored function, according to the table 3.6. The counter is cyclic, from 0 to 255. The monitored items are:

VARIABLE	DESCRIPTION
Lower Value/Upper Value	When any type of calibration is done.
Function	When any change in the transference function is done, e.g., linear, square root, const, table.
Trim_4mA	When the current trim is done at 4mA.
Trim_20mA	When the current trim is done at 20mA.
Trim_Zero/Lower	When pressure trim is done at Zero or Lower Pressure.
Trim Upper Pressure	When the trim is done at Upper Pressure.
Temperature Trim	When any change in the Temperature Trim.
TRM/PID	When any change is made in the operation mode, i.e., from PID to TRM or vice-versa.
Characterization	When any change is made in any point of the pressure characterization table in trim mode.
Multidrop	When any change is made in the communication mode, for example, multidrop or single transmitter.
Pswd/C-Level	When any change is made in the password or the level configuration.
Totalization	When any change is made in the totalization, configuration or in the reset.

**Table 3.6 – Functions Monitored by the Operation Counter**

- ✓ **BACKUP**  
When the main board is changed, after assembling and powering it, the data saved in the sensor memory are automatically copied to the main board memory, allowing its operation.
- ✓ **RESTORE**  
This option allows copying the data saved in the sensor memory to the main board memory. It also allows restoring to the main board the data stored in the sensor.

# PROGRAMMING USING LOCAL ADJUSTMENT

## The Magnetic Tool

The digital display enables the local adjustment function.

The local adjustment function may be used only through the digital display. The **LD301** on transmitter mode, without display and jumper-configured for simple mode, executes only the calibration function.

If it is on controller mode and without display, the local adjustment cannot be executed. On this situation and with the display connected, only the OPER and TOTAL functions may be executed.

Figure 4.1 shows the location of the local adjustment female pins to connect the Local Adjustment Jumpers.

**NOTE**

For the transmitter configuration to be totally available, the configurators should be based on PC to be utilized (e.g., DDL – device description language), like for instance the CONF401, or the hand held configurator, such as the Palm Top (HPC401).

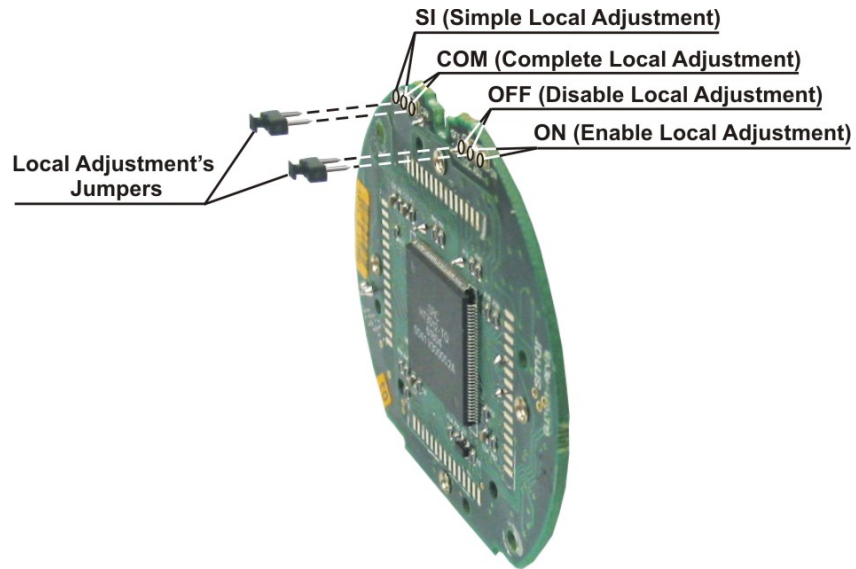

Figure 4.1 - Main Board with Jumpers

To select the function mode of the magnetic switches configure the jumpers located at the top of the main circuit board as indicated in Table 4.1.

SI/COM	OFF/ON	NOTE	WRITE PROTECT	SIMPLE LOCAL ADJUSTMENT	COMPLETE LOCAL ADJUSTMENT
● ● ○	● ● ○		Disables	Disables	Disables
○ ● ●	● ● ○	1	<b>Enables</b>	Disables	Disables
● ● ○	○ ● ●	2	Disables	<b>Enables</b>	Disables
○ ● ●	○ ● ●		Disables	Disables	<b>Enables</b>

**Notes:** 1 - If the hardware protection is selected, the EEPROM will be protected.  
 2 - The local adjustment default condition is simple enabled and write protect disabled.

Table 4.1 – Local adjustment Selection

The transmitter has, under the identification plate, holes for two magnetic switches activated by the magnetic tool (See Figure 4.2).

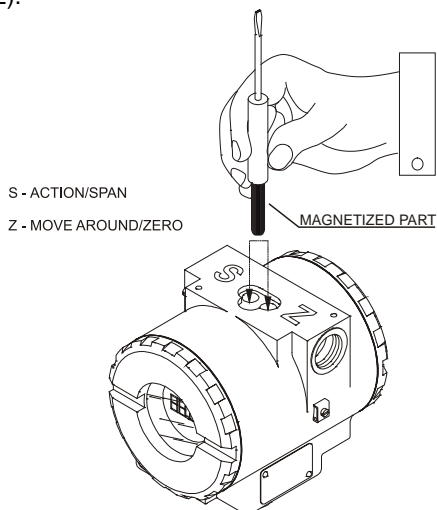

**Figure 4.2 – Local Zero and Span Adjustment holes and Local Adjustment Switches**

The holes are marked with **Z** (Zero) and **S** (Span) and from now on will be designated simply by **(Z)** and **(S)**, respectively. Table 4.2 shows the action performed by the magnetic tool while inserted in **(Z)** and **(S)** in accordance with the selected adjustment type.

Browsing the functions and their branches works as follows:

- 1 - Inserting the handle of the magnetic tool in **(Z)**, the transmitter passes from the normal measurement state to the transmitter configuration state. The transmitter software automatically starts to display the available functions in a cyclic routine. The group of functions displayed depends on the mode selected for the **LD301**, either Transmitter or Controller.
- 2 - In order to reach the desired option, browse the options, wait until they are displayed and move the magnetic tool from **(Z)** to **(S)**. Refer to Figure 4.3 – Local Adjustment Programming Tree, in order to know the position of the desired option. By placing the magnetic tool once again in **(Z)**, it is possible to browse other options within this new branch.
- 3 - The procedure to reach the desired option is similar to the one described on the previous item, for the whole hierarchical level of the programming tree.

ACTION	SIMPLE LOCAL ADJUSTMENT		COMPLETE LOCAL ADJUSTMENT
	TRANSMITTER MODE	CONTROLLER MODE	
<b>Z</b>	Selects the Lower Range Value	Moves among options in OPERATION and TOTAL	Moves among all the options
<b>S</b>	Selects the Upper Range Value	Activates the selected Functions	Activates the selected Functions

**Table 4.2 - Local Adjustment Description**

NOTE
For <b>LD301</b> versions prior to a V6.00, the digital display shall be number 214 - 0108 as per spare parts list for <b>LD301</b> V5.XX. For <b>LD301</b> versions V6.XX, the digital display shall be number 400-0559, as per the updated spare parts list.

## Simple Local Adjust

The **LD301** works differently when a simple local adjustment is selected in the transmitter mode and in the controller mode. In the transmitter mode, the simple local adjustment is used for Zero and Span calibration, and in the controller mode, it restricts the use of the configuration tree to the OPERATION and TOTALIZATION functions.



## Zero and Span Reranging

The **LD301** working in the transmitter mode can be very easily calibrated. It requires only Zero and Span adjustment in accordance with the working range.

To make these adjustments, the instrument must be configured as "transmitter" (XMTR). Via HART configurator or by using item "MODE" in option "CONF" of the local adjustment; the jumpers shall be configured for simple local adjustment. In case the **LD301** display is not connected, the simple local adjustment is automatically activated.

Zero calibration with reference shall be done as follows:

- ✓ Apply the Lower Value pressure.
- ✓ Wait for the pressure to stabilize.
- ✓ Insert the magnetic tool in the ZERO adjustment hole. (See Figure 4.2)
- ✓ Wait 2 seconds and soon the transmitter should be reading 4 mA.
- ✓ Remove the tool.

Zero calibration with reference does not affect the span. In order to change the span, the following procedure shall be observed:

- ✓ Apply the Upper Value pressure.
- ✓ Wait for the pressure to stabilize.
- ✓ Insert the magnetic tool in the SPAN adjustment hole.
- ✓ Wait 2 seconds. The transmitter should be reading 20 mA.
- ✓ Remove the tool.

Zero adjustment causes zero elevation or suppression and a new upper value (URV) are calculated in accordance with the effective span. In case the resulting URV is higher than the Upper Limit Value (URL), the URV will be limited to the URL value, and the span will be automatically affected.

### NOTE

On elevation or suppression measuring configure the user unit to facilitate the local reading.

## Complete Local Adjustment

The transmitter must be fitted with the digital display for this function to be enabled.

The following functions are available for local adjustment: Constant Current, Table Points Adjustment, User Units, Fail-safe, Current Trim and Pressure Characterization Trim, Totalization Parameters; Address change and Some items of function INFORMATION

### WARNING

When programming using local adjustment, the transmitter will not prompt "Control loop should be in manual!" as it does when using the HART® configurator for programming. Therefore it is a good idea, before configuration, to switch the loop to manual. And do not forget to return to auto after configuration is completed.

## Local Programming Tree

The local adjustment uses a tree structure where, by placing the magnetic tool in (**Z**) it is possible to browse the options of a branch and, by placing it in (**S**); details of the chosen option are shown. Figure 4.3 - Local Adjustment Programming Tree shows the **LD301** available options.

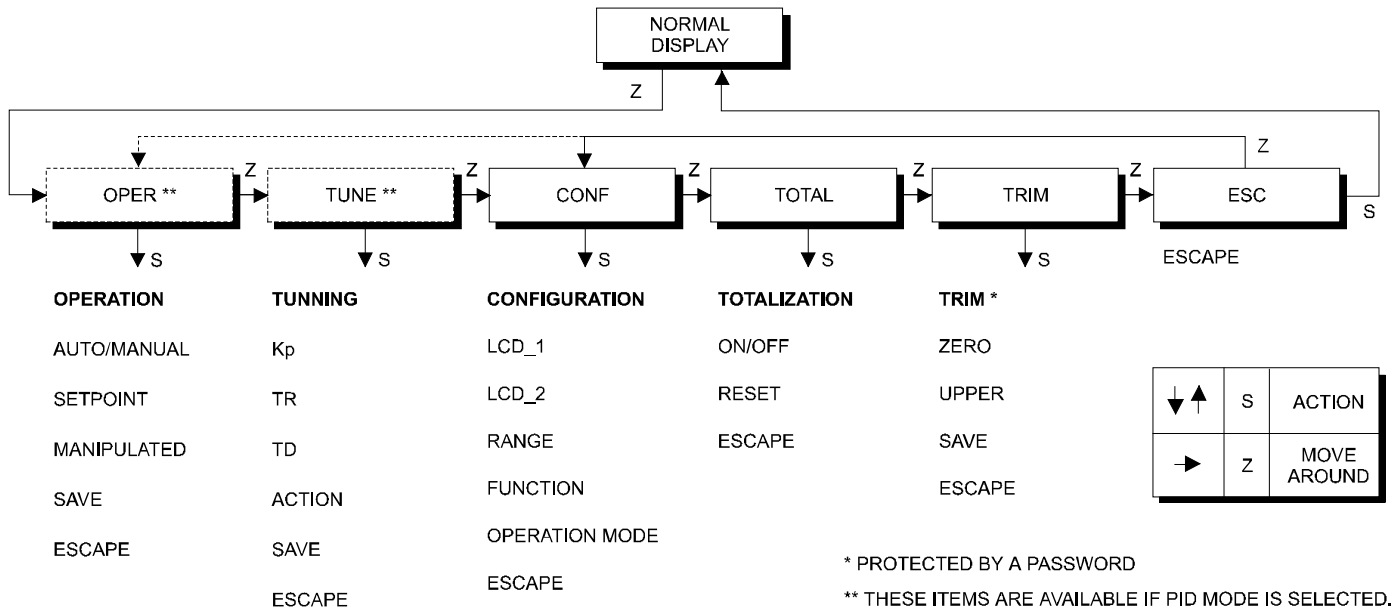

Figure 4.3 – Local Adjustment Programming Tree – Main Menu

Actuating in (Z) activates local adjustment. In the transmitter mode, options OPER and TUNE are disabled; therefore, the main branch starts at the CONF option.

**OPERATION (OPER)** - Is the option where the operation related parameters of the controller are configured: Auto/Manual, Setpoint and Manual output.

**TUNING (TUNE)** - Is the option where the PID-Algorithm related parameters are configured: Action, Kp, Tr and Td.

**CONFIGURATION (CONF)** - Is the option where the output and display related parameters are configured: unit, primary and secondary display, calibration, function and operation mode.

**TOTALIZATION (TOTAL)** - Is the option used to totalize flow in volume or mass units.

**TRIM (TRIM)** - Is the option used to calibrate the "without reference" characterization and the digital reading.

**ESCAPE (ESC)** - Is the option used to go back to normal monitoring mode.

## Operation [OPER]

This adjustment option is applicable to the LD301 configured in the Controller mode. It allows the control state to be changed from Automatic to Manual and vice versa, and also to adjust the Setpoint and Manipulated Variable values. Figure 4.4 shows branch OPER with the available options.

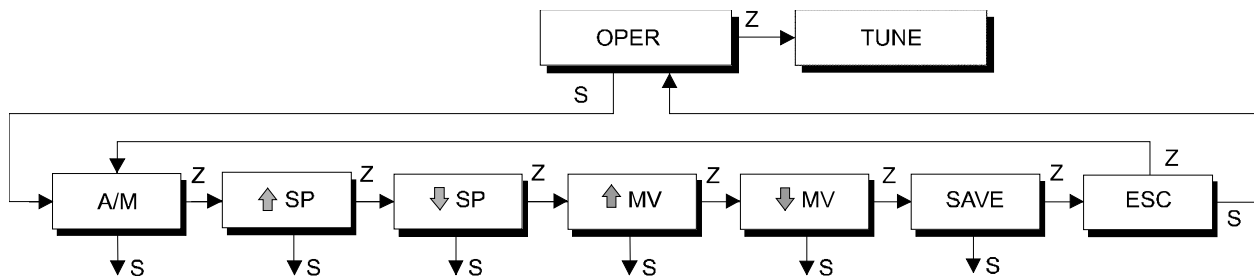
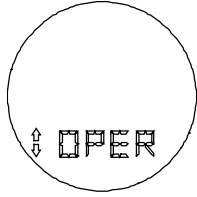

Figure 4.4 – Local Adjustment Operating Tree

**OPERATION BRANCH (OPER)**



**Z:** Moves to the next branch (TUNE).

**S:** Enters the OPERATION branch, starting with function AUTO/ MANUAL.

**Auto/Manual (A/M)**

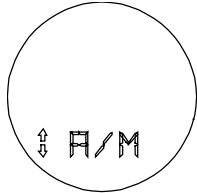

**Z:** Moves to the SETPOINT INCREASE function.

**S:** Toggles controller status, Automatic to Manual or Manual to Automatic. A and M indicate status.

**Setpoint Adjustment (SP)**

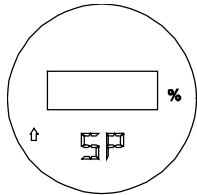

**Z:** Moves to the SETPOINT DECREASE function.

**S:** Increases the setpoint until the magnetic tool is removed or 100% is reached.

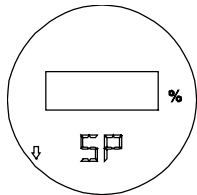

**Z:** Moves to the MANIPULATED VARIABLE ADJUSTMENT function.

**S:** Decreases the setpoint until the magnetic tool is removed or 0% is reached.

**Manipulated Variable Adjustment (MV)**

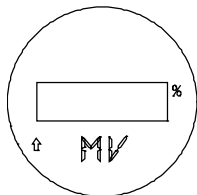

**Z:** Moves to the MANIPULATED VARIABLE DECREASE function.

**S:** Increases the control output until the magnetic tool is removed or the upper output limit is reached.

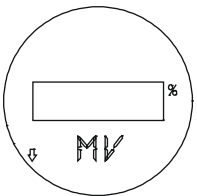

**Z:** Moves to the SAVE function.

**S:** Decreases the control output until the magnetic tool is removed or the lower output limit is reached.

**Save (SAVE)**

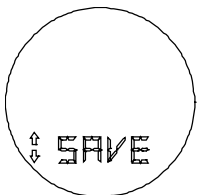

**Z:** Moves to ESCAPE of the operation menu.

**S:** Saves the setpoint and Manipulated Variable in the transmitter EEPROM, for use as power on SP and MV.

**Escape (ESC)**

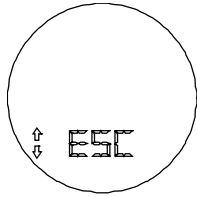

**Z:** Moves to the AUTO/ MANUAL function.

**S:** Escapes to the MAIN menu.

**Tuning [TUNE]**

This adjustment option is applicable to the LD301 configured in the Controller mode. It allows the control loop to be tuned, acting on the Proportional, Integral and Derivative terms, and also to alter the PID mode. The implemented algorithm is a PID type, with the following characteristics:

- ✓ The proportional action is given by the Proportional Gain and not by the proportional band. Range: 0 - 100.
- ✓ Integral action is expressed in minutes per repetition. Range: 0 - 999 min/rep.
- ✓ The derivative constant is obtained in seconds. Range 0 - 999 seconds.

It is possible to cancel the Integral and Derivative actions by adjusting Tr and Td, respectively to 0.

Figure 4.5 shows branch TUNE with the available options.

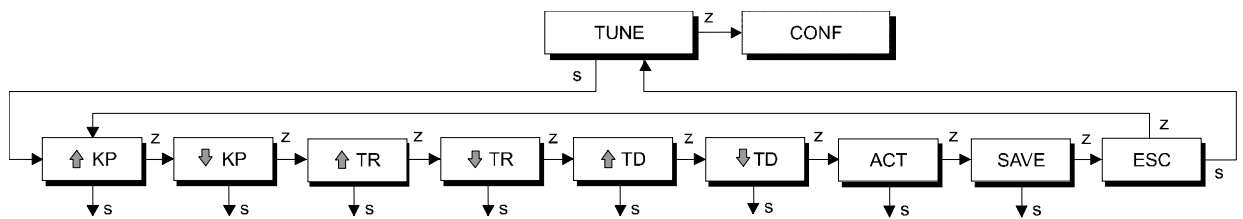

**Figure 4.5 - Local Adjustment Tuning Tree**

**TUNING BRANCH (TUNE)**

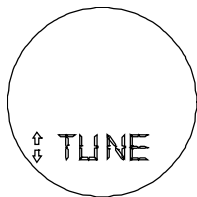

**Z:** Moves to the CONFIGURATION branch.

**S:** Enters the TUNING branch, starting with function KP-ADJUSTMENT, proportional gain increase option.

**Kp - Adjust (KP)**

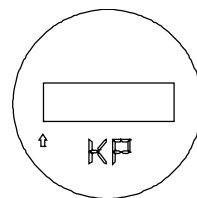

**Z:** Moves to the PROPORTIONAL GAIN DECREASE function.

**S:** Increases the proportional gain until the magnetic tool is removed or 100 is reached.

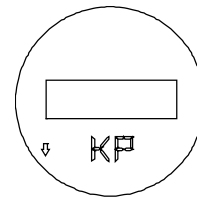

**Z:** Moves to the TR\_ADJUSTMENT function.

**S:** Decreases the proportional gain until the magnetic tool is removed or 0.0 is reached.

**Tr - Adjust (TR)**

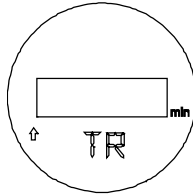

**Z:** Moves to the INTEGRAL TIME DECREASE function.

**S:** Increases the integral time until the magnetic tool is removed or 999 minutes are reached.

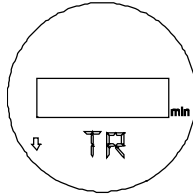

**Z:** Moves to the TD\_ADJUSTMENT function, derivative time increase option.

**S:** Decreases the integral time until the magnetic tool is removed or 0 minutes is reached.

**Td - Adjust (TD)**

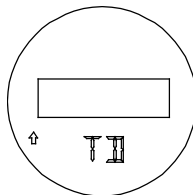

**Z:** Moves to the DERIVATIVE TIME DECREASE function.

**S:** Increases the derivative time until the magnetic tool is removed or 999 seconds are reached.

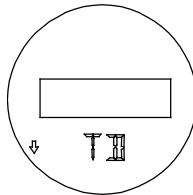

**Z:** Moves to the ACTION function.

**S:** Decreases the derivative time until the magnetic tool is removed or 0 seconds is reached.

**Action (ACT)**

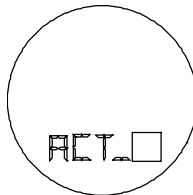

**Z:** Moves to the SAVE function.

**S:** Toggles the action direct to reverse or reverse to direct.  
The far right character of the unit/function-field indicates the present mode:  
D = direct action  
R = reverse action

**Save (SAVE)**

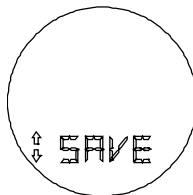

**Z:** Moves to the ESCAPE to TUNING menu.

**S:** Saves the KP, TR and TD constants in the transmitter EEPROM.

**Escape (ESC)**

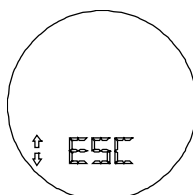

**Z:** Moves to the KP-ADJUSTMENT function.

**S:** Escapes to the MAIN menu.

## Configuration [CONF]

This branch is common for both the Transmitter and the Controller modes. Configuration functions affect directly the 4-20 mA output current and the display indication. The configuration options implemented in this branch are the following:

- ✓ Selection of the variable to be shown on Display 1 and on Display 2.
- ✓ Working range calibration for the Transmitter and the Controller. Options With and Without Reference are available.
- ✓ Digital filter damping time configuration of the readout signal input.
- ✓ Selection of the transference function to be applied to the measured variable.
- ✓ Operational mode selection for the **LD301**: Transmitter or Controller.

Figure 4.6 shows branch CONF with the available options.

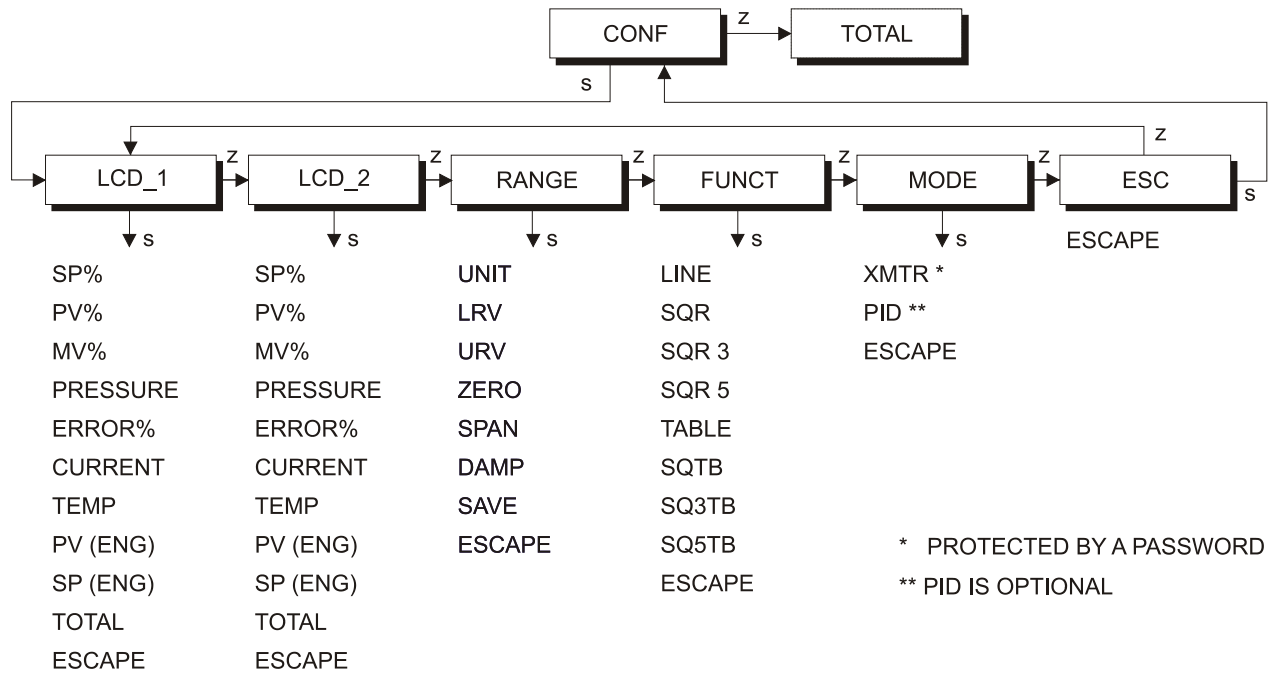
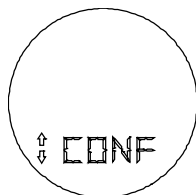

Figure 4.6 – Local Adjustment Configuration Tree

### CONFIGURATION BRANCH (CONF)



**Z:** Moves to the TOTAL branch.

**S:** Enters the CONFIGURATION branch, starting with function display (LCD\_1).

### Display 1 (LCD\_1)

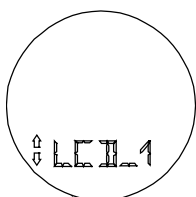

**Z:** Moves to the function Display 2 (LCD\_2).

**S:** Starts selection of variable to be indicated as primary display. After activating (**S**), you can move around the options available in the following table by activating (**Z**). See table 4.3.

The desired variable is activated using (**S**). Escape leaves primary variable unchanged.

Display 2 (LCD\_2)

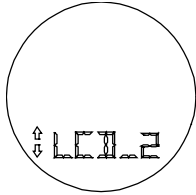

**Z:** Moves to the RANGE function.

**S:** Starts selection of variable to be indicated as secondary display. The procedure for selection is the same as for LCD\_1, above.

Display: LCD_1/LCD_2	Description
CO	Analog Output Current in mA
MV (%)	Output in percentage
PR	Pressure in pressure unit
PV (%)	Process Variable in percentage
PV	Process Variable in user unit
TE	Temperature in Celsius degree
SP (%)	Setpoint in percentage
SP	Setpoint in user unit
ER	Error or Deviation in percentage
TO	Totalization in totalization unit
	NONE - No variable on display (only LCD_2)
ESC	Escape

Table 4.3 - Display Indication

**NOTE**

In the transmitter mode, only the **PV%**, **CO**, **TE**, **TO** and **PV** may be displayed. Besides, it is also possible to select option **None** for **Display 2**.

Range (RANGE)

Function Calibration (RANGE) presents the calibration options as a tree branch, as described on Figure 4.7.

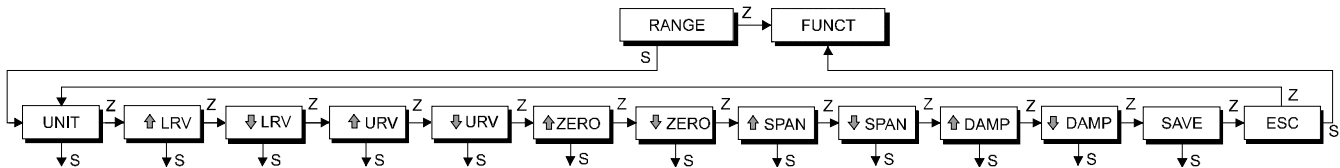
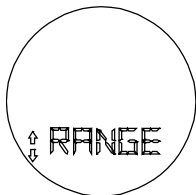

Figure 4.7 – Local Range Tree

RANGE BRANCH (RANGE)



**Z:** Moves to the FUNCT function, CONF branch.

**S:** Enters the RANGE branch, starting with the function UNIT.

Unit (UNIT)

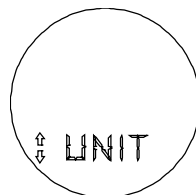

**Z:** Moves to the LRV function, LRV decrease option.

**S:** Starts selection of engineering unit for process variable and setpoint indication. After activating (S), you can move around the options available in the table below by activating (Z). Using (S) activates the desired unit. Escape leaves the unit unchanged.

UNIT	
DISPLAY	DESCRIPTION
InH <sub>2</sub> O	inches water column at 20 °C
InHg	inches mercury column at 0 °C
ftH <sub>2</sub> O	feet water column at 20 °C
mmH <sub>2</sub> O	millimeter water column at 20 °C
mmHg	millimeter mercury column at 0 °C
psi	pounds per square inches
Bar	bar
Mbar	millibar
g/cm <sup>2</sup>	grams per square centimeter
k/cm <sup>2</sup>	quilograms per square centimeter
Pa	Pascals
kPa	quilo Pascals
Torr *	Torr at 0 °C
atm	atmospheres
ESC	escape

Table 4.4 – Units

\* The Torr unit has been changed to mH<sub>2</sub>O @ 20 °C for version 6.04 or greater.

**Lower Range Value Adjustment without Reference (LRV)**

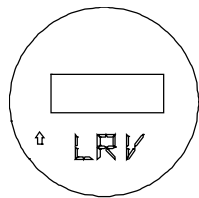

**Z:** Moves to the LRV DECREASE function.

**S:** Increases the Lower Value until the magnetic tool is removed or the maximum Lower Value is reached.

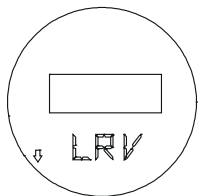

**Z:** Moves to the URV ADJUSTMENT function.

**S:** Decreases the Lower Value until the magnetic tool is removed or the minimum Lower Value is reached.

**Upper Range Value Adjust without Reference {URV}**

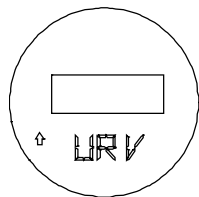

**Z:** Moves to the URV DECREASE function.

**S:** Increases the Upper Value until the magnetic tool is removed or the maximum Upper Value is reached.

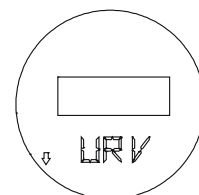

**Z:** Moves to the ZERO ADJUSTMENT function.

**S:** Decreases the Upper Value until the magnetic tool is removed or the minimum Upper Value is reached.



**Zero Adjust with Reference {ZERO}**

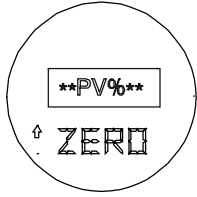

**Z:** Moves to the ZERO DECREASE function.

**S:** Increases output in transmitter mode, decreases the Lower Pressure Value until the magnetic tool is removed or the minimum for the Lower Value is reached. The span is maintained.

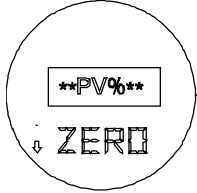

**Z:** Moves to the SPAN ADJUSTMENT function.

**S:** Decreases Output in transmitter mode, increases the Lower Pressure Value until the magnetic tool is removed or the maximum for the Lower Value is reached. The span is maintained.

**Span Adjust with Reference (SPAN)**

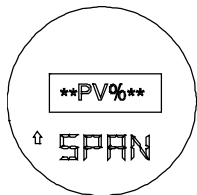

**Z:** Moves to the SPAN DECREASE function.

**S:** Increases the Output in transmitter mode, decreases the Upper Pressure Value until the magnetic tool is removed or the minimum for the Upper Value is reached.

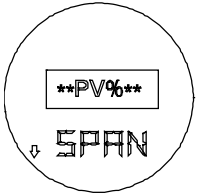

**Z:** Moves to the DAMPING function.

**S:** Decreases the Output in transmitter mode, increases the Upper Pressure Value until the magnetic tool is removed or the maximum for the Upper Value is reached.

**Damping (DAMP)**

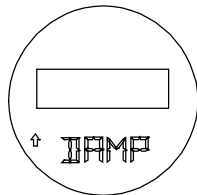

**Z:** Moves to the DAMPING DECREASE function.

**S:** Increases the damping time constant until the magnetic tool is removed or 128 seconds are reached.

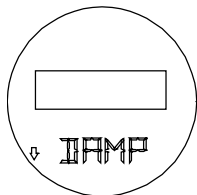

**Z:** Moves to the SAVE function.

**S:** Decreases the damping time constant until the magnetic tool is removed or 0 seconds is reached.

**Save (SAVE)**

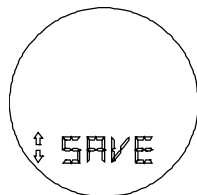

**Z:** Moves to the ESCAPE of RANGE menu.

**S:** Saves the LRV, URV, ZERO, SPAN and DAMP values in the transmitter EEPROM.

**Escape (ESC)**

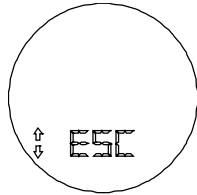

**Z:** Moves to the UNIT function.

**S:** Escapes to the FUNCT menu, of the MAIN menu.

**Function (FUNCT)**

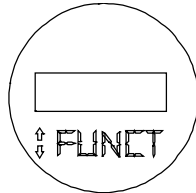

**Z:** Moves to the MODE function.

**S:** Starts selection of transfer function. After activating the switch in the hole (**S**), you can move around the available options in the table 4.5 by activating (**Z**).

FUNCTIONS	
DISPLAY	DESCRIPTION
LINE	Linear to Pressure
SQR	$\sqrt{x}$
SQR3	$\sqrt{x^3}$
SQR5	$\sqrt{x^5}$
TABLE	16 Point Table
SQTB	$\sqrt{x} + 16$ Point Table
SQ3TB	$\sqrt{x^3} + 16$ Point Table
SQ5TB	$\sqrt{x^5} + 16$ Point Table
ESC	escape

**Table 4.5 – Functions**

The desired function is activated using (**S**). Escape leaves function unchanged.

**Escape (ESC)**

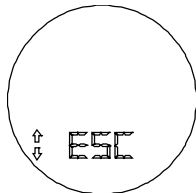

**Z:** Moves to the LINE function.

**S:** Escapes to the MODE function.

**Operation Mode (MODE)**

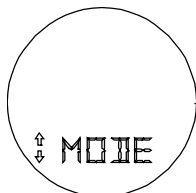

**Z:** Moves to the ESCAPE to CONF menu.

**S:** This function is protected by a "password," when prompted PSWD, enter the password. The password code is entered by inserting and removing the magnetic tool twice in (**S**). The first time, the password value is changed from 0 to 1, and the second time **XMTR/PID** is shown, meaning that the password was correct and that the branch is entered and the setting changed.

After entering the "password," you can move around the options listed in the table below using (Z). To select the desired option, activate (S). See Table 4.6.

OPERATION MODES	
DISPLAY	DESCRIPTION
XMTR	Transmitter
PID	Controller
ESC	escape

Table 4.6 - Operation Modes

Escape (ESC)

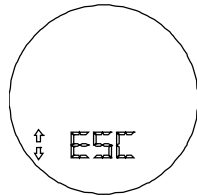

- Z: Recycles back to the function Display 1 (LCD\_1).
- S: Escapes to the MAIN menu.

**Totalization [TOTAL]**

This branch is common for both the Transmitter and the Controller modes. Totalization parameters are configured via HART Configurator, because it requires a more elaborate human-machine interface, as described on Section 3. The functions available in this branch are directly related with the totalized value, these being stopping or continuing the totalization process and zeroing the totalized value. See Figure 4.8.

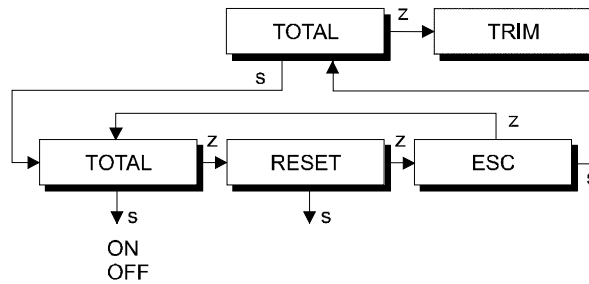
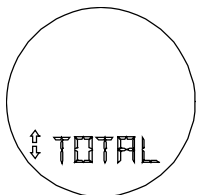

Figure 4.8 – Local Totalization Tree

**Totalization Branch (TOTAL)**



- Z: Moves to the Pressure TRIM branch.
- S: Enters the totalization branch, starting with function Total on/ off.

**Totalization ON-OFF (TOTAL)**

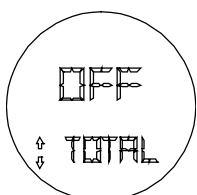

- Z: Moves to the RESET function.
- S: Toggles the totalization On to Off or Off to On.

**Reset Totalization (RESET)**

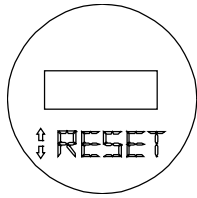

- Z:** Moves to the ESCAPE from the totalization menu.
- S:** Reset the totalization.

**Escape (ESC)**

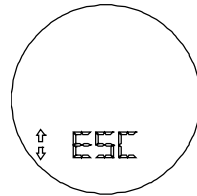

- Z:** Moves to the TOTAL function.
- S:** Escapes to the main menu.

**Pressure Trim [TRIM]**

This field of the tree is used to adjust the digital reading according to the applied pressure. The pressure TRIM differs from RANGING WITH REFERENCE, since the TRIM is used to correct the measure and RANGING WITH REFERENCE reach only the applied pressure with the output signal of 4 to 20 mA. Figure 4.9 shows the options available to run the pressure TRIM.

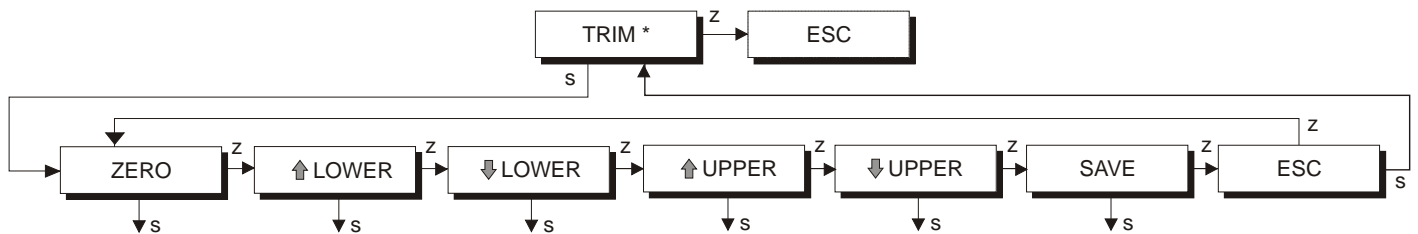

\* PROTECTED BY PASSWORD. THE PASSWORD CODE IS SIMILAR THAT DESCRIBED FOR THE OPERATION MODE.

Figure 4.9 – Pressure Trim Tree

**TRIM BRANCH (TRIM)**

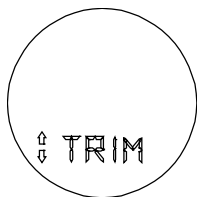

- Z:** Moves to ESC function.
- S:** These functions are protected by a "password." When prompted, PSWD activates (S) 2 times to proceed. After entering the password, the TRIM branch starting with the Zero Trim function is accessed.

**Zero Pressure Trim (ZERO)**

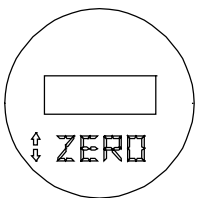

- Z:** Moves to the LOWER pressure TRIM function.
- S:** Trims the transmitter internal reference to read 0 at the applied pressure.

**Lower Pressure Trim (Lower)**

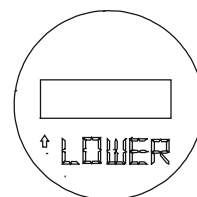

- Z:** Moves to option DECREASES THE LOWER PRESSURE VALUE.
- S:** Adjusts the transmitter internal reference, increasing the displayed value that will be interpreted as the Lower Pressure value corresponding to the applied pressure.

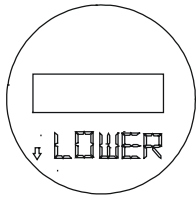

**Z:** Moves on to function SAVE if the Lower Pressure Trim (LOWER) is running or to the Upper Pressure Trim (UPPER).

**S:** Adjusts the transmitter internal reference, decreasing the displayed value that will be interpreted as the Lower Pressure value corresponding to the applied pressure.

**Upper Pressure Trim (UPPER)**

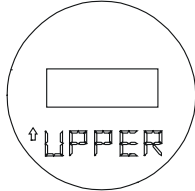

**Z:** Moves to the decrease upper pressure reading.

**S:** Sets the transmitter internal reference increasing to the value on the display, which is the reading of the applied pressure.

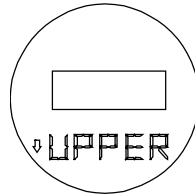

**Z:** Moves to the SAVE function.

**S:** Sets the transmitter internal reference decreasing to the value on the display, which is the reading of the applied pressure.

**Save (SAVE)**

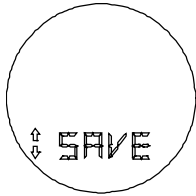

**Z:** Moves to the ESCAPE from TRIM menu.

**S:** Saves the UPPER and LOWER TRIM point in the transmitter EEPROM.

**Escape (ESC)**

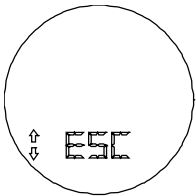

**Z:** Moves to the ZERO TRIM function.

**S:** Escapes to the MAIN menu.

**Escape Local Adjustment [ESC]**

This branch of the main tree is used to leave the Local Adjustment mode, placing the Transmitter or Controller in the monitoring mode.

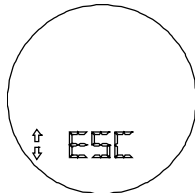

**Z:** Selects the OPERATION branch (Controller) or CONFIGURATION branch (Transmitter).

**S:** Escapes to NORMAL DISPLAY mode.



## Section 5

# MAINTENANCE

### General

#### NOTE

Equipments installed in hazardous atmospheres must be inspected in compliance with the IEC60079-17 standard.

Below, there are some important maintenance procedures that should be followed in order to have safer plant and easy maintenance.

In general, it is recommended that end users do not try to repair printed circuit boards. Spare circuit boards may be ordered from **SMAR** whenever necessary.

The sensor has been designed to operate for many years without malfunctions. Should the process application require periodic cleaning of the transmitter, the flanges may be easily removed and reinstalled.

Should the sensor eventually require maintenance, it may not be changed on the field. In this case, the possibly damaged sensor should be returned to **SMAR** for evaluation and, if necessary, repair. Refer to the "Returning Materials" item at the end of this Section.

### Diagnostic using Configuration Tool

Should any problem be noticed regarding the transmitter output, the configurator can be used to verify what is the problem (see Table 5.1).

The configurator should be connected to the transmitter according to the wiring diagram shown on Section 1, Figures 1.7, 1.8 and 1.9.

### Error Messages

When communicating using the CONFIGURATOR the user will be informed about any problem found by the transmitter self-diagnostics.

Table 5.1 presents a list of error messages with details for corrective actions that may be necessary.

ERROR MESSAGES	POTENTIAL SOURCE OF PROBLEM
<b>UART RECEIVER FAILURE:</b>	<ul style="list-style-type: none"><li>• The line resistance is not according to load limitation.</li><li>• Excessive noise or ripple in the line.</li><li>• Low level signal.</li><li>• Interface damaged.</li><li>• Power supply with inadequate voltage.</li></ul>
• <b>PARITY ERROR</b>	
• <b>OVERRUN ERROR</b>	
• <b>ERROR CHECK SUM</b>	
• <b>FRAMING ERROR</b>	
<b>CONFIGURATOR RECEIVES NO ANSWER FROM TRANSMITTER</b>	<ul style="list-style-type: none"><li>• Transmitter line resistance is not according to load limitation.</li><li>• Transmitter not powered.</li><li>• Interface not connected or damaged.</li><li>• Repeated bus address.</li><li>• Transmitter polarity is reversed.</li><li>• Interface damaged.</li><li>• Power supply with inadequate voltage.</li></ul>
<b>CMD NOT IMPLEMENTED</b>	<ul style="list-style-type: none"><li>• Software version not compatible between configurator and transmitter.</li><li>• Configurator is trying to carry out a <b>LD301</b> specific command in a transmitter from another manufacturer.</li></ul>
<b>TRANSMITTER BUSY</b>	<ul style="list-style-type: none"><li>• Transmitter carrying out an important task, e.g., local adjustment.</li></ul>
<b>XMTR MALFUNCTION</b>	<ul style="list-style-type: none"><li>• Sensor disconnected.</li><li>• Sensor failure.</li></ul>
<b>COLD START</b>	<ul style="list-style-type: none"><li>• Start-up or Reset due to power supplies failure.</li></ul>

ERROR MESSAGES	POTENTIAL SOURCE OF PROBLEM
OUTPUT FIXED	<ul style="list-style-type: none"> <li>• Output in Constant Mode.</li> <li>• Transmitter in Multidrop mode.</li> </ul>
OUTPUT SATURATED	<ul style="list-style-type: none"> <li>• Pressure out of calibrated Span or in fail-safe state (Output current in 3.8 or 20.5 mA).</li> </ul>
SV OUT OF LIMITS	<ul style="list-style-type: none"> <li>• Temperature out of operating limits.</li> <li>• Temperature sensor damaged.</li> </ul>
PV OUT OF LIMITS	<ul style="list-style-type: none"> <li>• Pressure out of operation limits.</li> <li>• Sensor damaged or sensor module not connected.</li> <li>• Transmitter with false configuration.</li> </ul>
LOWER RANGE VALUE TOO HIGH	<ul style="list-style-type: none"> <li>• Lower value exceeds 24% of the Upper Range Limit.</li> </ul>
LOWER RANGE VALUE TOO LOW	<ul style="list-style-type: none"> <li>• Lower value exceeds 24% of the Lower Range Limit.</li> </ul>
UPPER RANGE VALUE TOO HIGH	<ul style="list-style-type: none"> <li>• Upper value exceeds 24% of the Upper Range Limit.</li> </ul>
UPPER RANGE VALUE TOO LOW	<ul style="list-style-type: none"> <li>• Upper value exceeds 24% of the Lower Range Limit.</li> </ul>
UPPER & LOWER RANGE VALUES OUT OF LIMITS	<ul style="list-style-type: none"> <li>• Lower and Upper Values are out of the sensor range limits.</li> </ul>
SPAN TOO SMALL	<ul style="list-style-type: none"> <li>• The difference, between the Lower and Upper values is less than the 0.75 x (minimum span).</li> </ul>
APPLIED PRESURE TOO HIGH	<ul style="list-style-type: none"> <li>• The pressure applied was above the 24% upper range limit.</li> </ul>
APPLIED PRESURE TOO LOW	<ul style="list-style-type: none"> <li>• The pressure applied was below the 24% lower range limit.</li> </ul>
EXCESS CORRECTION	<ul style="list-style-type: none"> <li>• The trim value entered exceeded the factory-characterized value by more than 10%.</li> </ul>
PASSED PARAMETER TOO LARGE	<ul style="list-style-type: none"> <li>• Parameter above operating limits.</li> </ul>
PASSED PARAMETER TOO SMALL	<ul style="list-style-type: none"> <li>• Parameter below operating limits.</li> </ul>

Table 5.1 - Error Messages and Potential Source

## Diagnostic via Transmitter

### NOTE

D0 and M0 ranges are available only for 6.05 versions or greater.

#### Symptom: NO LINE CURRENT

##### Probable Source of Trouble:

##### ✓ Transmitter Connections

- Check wiring polarity and continuity.
- Check for shorts or ground loops.
- Check if the power supply connector is connected to main board.

##### ✓ Power Supply

- Check power supply output. The voltage must be between 12 and 45 Vdc at transmitter terminals.

##### ✓ Electronic Circuit Failure

- Check the main board for defect by using a spare one.



**Symptom: NO COMMUNICATION****Probable Source of Trouble:**

- ✓ **Terminal Connections**
  - Check the terminal interface connection of the configurator.
  - Check if the interface is connected to the wires leading to the transmitter or to the terminals [ + ] and [ - ].
  - Check if the interface is HPI311 – M5P models (for Hart protocol).
- ✓ **Transmitter Connections**
  - Check if connections are according to wiring diagram.
  - Check if there is resistance in the 250  $\Omega$  line. See load limitation in Section 1.
- ✓ **Power Supply**
  - Check output of power supply. The voltage at the **LD301** terminals must be between 12 and 45 Vdc, and ripple less than 500 mV.
- ✓ **Electronic Circuit Failure**
  - Locate the failure by alternately testing the transmitter circuit and the interface with spare parts.
- ✓ **Transmitter Address**
  - Check if the transmitter address is compatible with the one expected by the configurator.

**Symptom: CURRENT in 21.0 mA or 3.6 mA****Probable Source of Trouble:**

- ✓ **Pressure Tap (Piping)**
  - Verify if blocking valves are fully open.
  - Check for gas in liquid lines or for liquid in dry lines.
  - Check the specific gravity of process fluid.
  - Check process flanges for sediments.
  - Check the pressure connection.
  - Check if bypass valves are closed.
  - Check if pressure applied is not above upper limit of the transmitter range.
- ✓ **Sensor to Main Circuit Connection**
  - Sensor connection to the Main Board.
  - Check connection (male and female connectors).
- ✓ **Electronic Circuit Failure**
  - Check the sensor circuit for damage by replacing it with a spare one.
  - Replace sensor.

**Symptom: INCORRECT OUTPUT****Probable Source of Trouble:**

- ✓ **Transmitter Connections**
  - Check power supply voltage.
  - Check for intermittent short circuits, open circuits and grounding problems.
- ✓ **Noise Measurement Fluid**
  - Adjust damping
- ✓ **Pressure Tap**
  - Check for gas in liquid lines and for liquid in steam or gases lines.
  - Check the integrity of the circuit by replacing it with a spare one.
- ✓ **Calibration**
  - Check calibration of the transmitter.

**NOTE**

A 21.0 or 3.6 mA current indicates that the transmitter is in Burnout (TRM) or safety output (PID). Use the configurator to investigate the source of the problem.

**Symptom: DISPLAY INDICATES "FAIL SENS"**

**Probable Source of Trouble:**

- ✓ **Sensor Connection to the Main Board**  
Check the connection (flat cable, male and female connectors).
- ✓ **Type of Sensor Connected to the Main Board**  
Check if the sensor connected to the main board is the one specified for the **LD301** model: Sensor type shall be hyper - High Performance.
- ✓ **Electronic Circuit Failure**  
Check if the sensor set is damaged, replacing it for a spare one.

## Disassembly Procedure

**WARNING**

Do not disassemble with power on.

Figure 5.1 shows a transmitter exploded view and will help you to visualize the following:

### Sensor

In order to have access to the sensor (**27**) for cleaning purposes, the transmitter should be removed from its process connections. The transmitter should be isolated from the process by means of manifolds or valves; then, the drain (**23**) must be opened to vent any remaining pressure.

After this, the transmitter may be removed from the standpipe. The flange bolts (**18**) may now be loosened, one at a time. After removing bolts and flanges (**17**), the isolating diaphragms will be easily accessible for cleaning.

Cleaning should be done carefully in order to avoid damaging the delicate isolating diaphragms. Use of a soft cloth and a nonacid solution is recommended.

To remove the sensor from the electronic housing, the electrical connections (in the field terminal side) and the main board connector must be disconnected.

Loosen the hex screw (**8**) and carefully unscrew the electronic housing from the sensor, observing if the flat cable is not excessively twisted.

**WARNING**

To avoid damage do not rotate the electronic housing more than 270° starting from the fully threaded without disconnecting the electronic circuit from the sensor and from the power supply. See Figure 5.2.

### Electronic Circuit

To remove the circuit board (**6**), loosen the two screws (**5**), that anchor the board and hold the (**7**) spacers in the other side to avoid losing them.

**WARNING**

The board has CMOS components, which may be damaged by electrostatic discharges. Observe correct procedures for handling CMOS components. It is also recommended to store the circuit boards in electrostatic-proof cases.

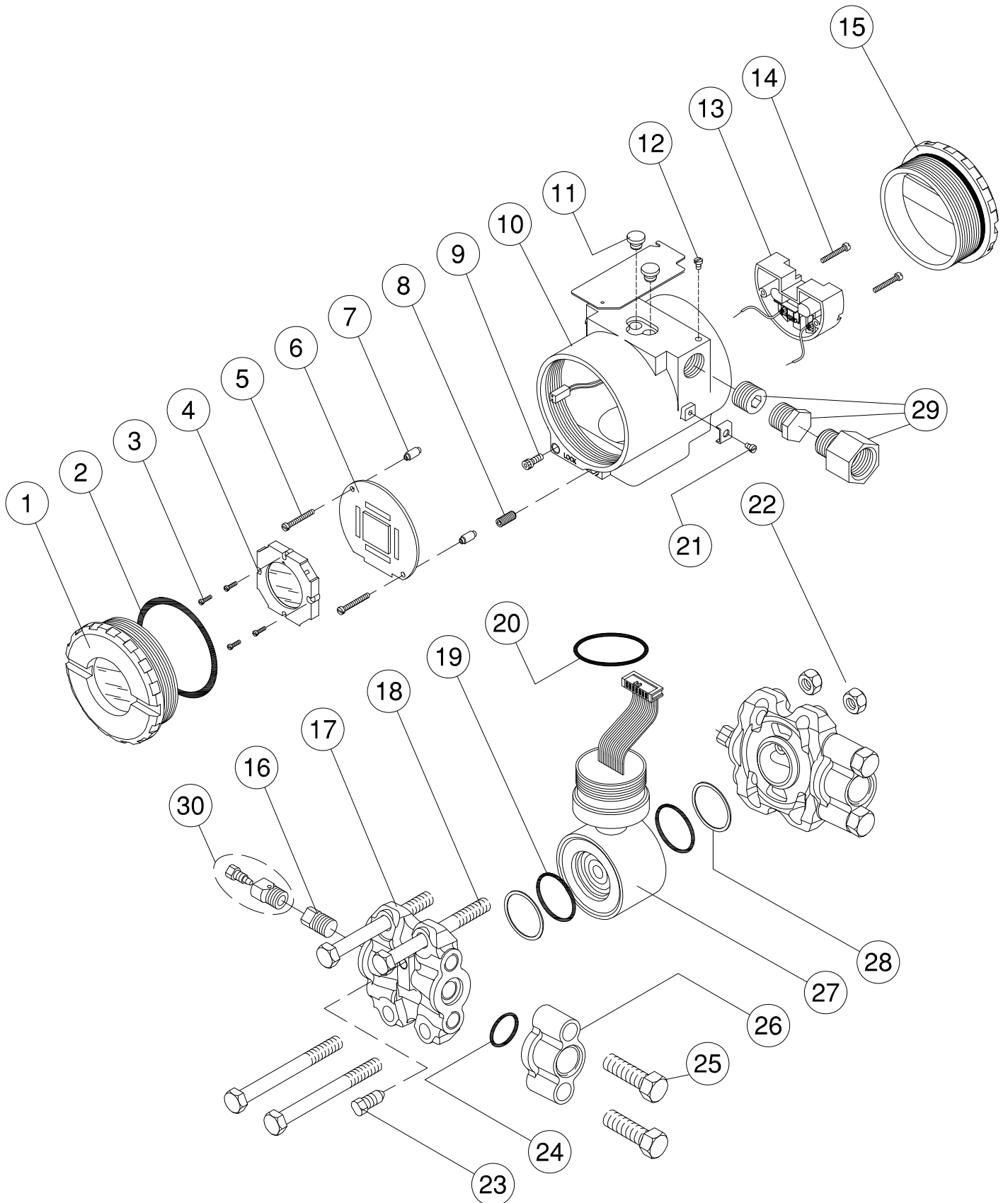

Figure 5.1 – Exploded View



Figure 5.2 – Sensor Safety Rotation

Pull the main board out of the housing and disconnect the power supply and the sensor connectors.

## Reassembly Procedure

### WARNING

Do not assemble with power on.

### Sensor

When mounting the sensor (27), make use of a new set of gaskets (19 & 20) compatible with the process fluid. The bolts, nuts, flanges and other parts should be inspected for corrosion or other eventual damage. Damaged parts should be replaced.

The O-rings should be lightly lubricated with silicon oil before they are fitted into place. Use halogen grease on applications having inert filling fluid. The flanges must be positioned on a flat surface. Insert the gaskets and Backup (28) (only for high pressure) in the flange according to figure 5.1. Set the four bolts (18) and tighten the nuts (22) initially by hand while keeping the flanges parallel through the whole mounting and finalize with an adequate tool.

### O'RINGS AND BACKUP RINGS FOR HIGH PRESSURE

High pressure transmitters A5, A6, M5, M6 and High static pressure H2, H3, H4, H5 and the sensors with tantalum diaphragm that use Buna-N or Viton O-ring must use a metallic backup Ring (28) to prevent extrusion of O-ring. Do not use the backup O-Ring when using Teflon O-Rings or flanges that have Kynar insets (PVDF).

Avoid bending the backup ring and inspect it for knits, cuts etc. Be careful when mounting it. The flat side, which shines more than the beveled side, shall be mounted against the O-ring (Figure 5.3).

### Procedure for tightening the flange screws

With the flanges holding the O-Rings in place, insert the four bolts (18) and tight the nuts (22) finger tight, making sure the flanges remain parallel all the time.

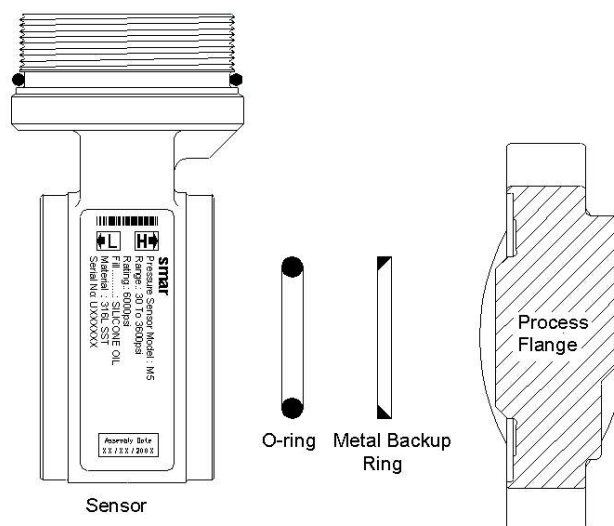

**Figure 5.3 – Backup Ring Mounting**

- Tighten one nut till the flange seats;
- Tighten the nut diagonally across with a torque of approximately  $2.75 \pm 0.25$  Kgf.m;
- Tighten the first nut with the same torque;
- Verify the flanges alignment;
- Check torque on the four bolts.

Should the adapters (26) be removed, it is recommended to replace gaskets (24) and to connect the adapters to the process flanges before coupling them to the sensor. Optimum torque is  $2.75 \pm 0.25$  Kgf.m.

The fitting of the sensor must be done with the main board out of the electronic housing. Mount the sensor to the housing turning it clockwise until it stops. Then turn it counterclockwise until the cover (1) is parallel to the process flange (17). Tighten the screw (8) to lock the body to the sensor.

## Electronic Circuit

Plug sensor connector and power supply connector to main board. If there is a display, attach it to the main board by means of 4 screws (3). The display can be installed in any of the 4 possible positions (See Figure 5.4).

The "▲" mark indicates up position.

Pass the screws (5) through the main board holes (6) and the spacers (7) as shown on Figure 5.1 and tighten them to the body.

After tightening the protective cover (1), mounting procedure is complete. The transmitter is ready to be energized and tested. It is recommended that adjustment be done on the ZERO TRIM and on the UPPER PRESSURE TRIM.

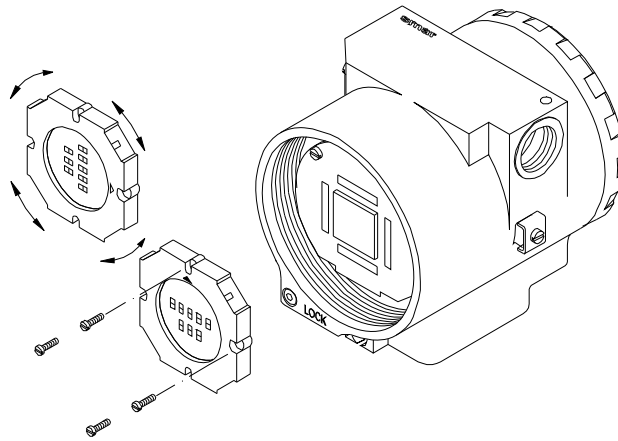

Figure 5.4 – Four Possible Positions of the Display

## Interchangeability

In order to obtain an accurate and better temperature compensated response, each sensor is submitted to a characterization process and the specific data is stored in an EEPROM located in the sensor body.

The main board, in this operation, reads the sensor serial number and compares it with the number stored in the main board. In case they do not match, the circuit considers that the sensor has been changed and will probe the memory of the new sensor for the following information:

- ✓ Temperature compensation coefficients.
- ✓ Sensor trim data, including 5-point characterization curve.
- ✓ Sensor characteristics: type, range, diaphragm material and fill fluid.

Information not transferred during sensor replacement will remain unchanged in the main board memory. Thus, information such as Upper Value, Lower Value, Damping, Pressure Unit and replaceable transmitter parts (Flange, O-ring, etc.) shall be updated, depending whether the correct information is that of the sensor or the main board. In the case of a new sensor, the main board will have the most updated information; in the opposite case, the sensor will have the correct information. Depending on the situation, the updating shall be from one or the other.

Data transference from the main board to the sensor or vice versa can also be forced by function MAINT/BACKUP/READ FROM SENSOR.

## Returning Materials

Should it become necessary to return the transmitter and/or configurator to **SMAR**, simply contact our office, informing the defective instrument serial number, and return it to our factory.

If it becomes necessary to return the transmitter and/or configurator to Smar, simply contact our office, informing the defective instrument's serial number, and return it to our factory. In order to speed up analysis and solution of the problem, the defective item should be returned with the Service Request Form (SRF – Appendix B) properly filled with a description of the failure observed and with as much details as possible. Other information concerning to the instrument operation, such as service and process conditions, is also helpful.

Instruments returned or to be revised outside the guarantee term should be accompanied by a purchase order or a quote request.

ACCESSORIES	
ORDERING CODE	DESCRIPTION
SD-1	Magnetic Tool for local adjustment.
Palm*	16 Mbytes Palm Handheld, Including HPC401's initialization and installation software.
HPC401*	HART® HPI311 for the Palm, including the configuration package for the Smar and generic transmitters.
HPI311*	HART® interface.

\*For equipment updates and HPC401 software, just check: <http://www.smarresearch.com>.

SPARE PARTS LIST FOR TRANSMITTER				
DESCRIPTION OF PARTS		POSITION	CODE	CATEGORY (NOTE 1)
HOUSING, Aluminum (NOTE 2)	. 1/2 - 14 NPT	10	204-0130	
	. M20 x 1.5	10	204-0131	
	. PG 13.5 DIN	10	204-0132	
HOUSING, 316 Stainless Steel (NOTE 2)	. 1/2 - 14 NPT	10	204-0133	
	. M20 x 1.5	10	204-0134	
	. PG 13.5 DIN	10	204-0135	
COVER (Includes O-ring)	. Aluminum	1 and 15	204-0102	
	. 316 SST	1 and 15	204-0105	
COVER WITH WINDOW FOR INDICATOR (Includes O-ring)	. Aluminum	1	204-0103	
	. 316 SST	1	204-0106	
COVER LOCKING SCREW		9	204-0120	
SENSOR LOCKING SCREW	Without Head M6 Screw	8	400-1121	
EXTERNAL GROUND SCREW		21	204-0124	
IDENTIFICATION PLATE FIXING SCREW		12	204-0116	
DISPLAY ( Included Screws )		3 and 4	400-0559	
TERMINAL BLOCK INSULATOR		13	400-0058	
MAIN BOARD ( Display and mounting Kit Included ) - GLL 1071		6	400-0557	A
MAIN BOARD ( Display and Mounting Kit not Included ) - GLL 1071		6	400-0558	A
MAIN BOARD with Mounting Kit and without display - GLL 1071		6	400-0587	A
FIXATION MAIN BOARD KIT ( Screws and Spacers )	316 SST	5 and 7	400-0560	
PLUG	1/2 NPT Internal Hexagon Plug in Plated CS (Ex d)	29	400-0808	
	1/2 NPT Internal Hexagon Plug in 304 SST (Ex d)	29	400-0809	
	M20 X 1.5 External Hexagon Plug in 316 SST (Ex d)	29	400-0810	
	PG 13.5 External Hexagon Plug in 316 SST (Ex d)	29	400-0811	
	1/2 NPT Internal Socket Set Plug in Plated CS	29	400-0583-11	
	1/2 NPT Internal Socket Set Plug in 304 SST	29	400-0583-12	
ADAPTOR FOR ELECTRIC CONNECTION	3/4 NPT female for 1/2 NPT male, SST 316	-	400-0812	
DRAIN/ VENT VALVE	316 SST	30	400-0792	
FLANGE (WITH HOLE FOR DRAIN/VENT)	. Plated CS	17	204-0501	
	. SST 316 CF8M (ASTM - A351)	17	204-0502	
	. Hastelloy C276 (CW - 12MW, ASTM - A494)	17	204-0503	
	. Monel 400	17	204-0504	
FLANGE (WITH HOLE FOR DRAIN/VENT) setting and 7/16" UNF connection SAE J1926	. SST 316 CF8M (ASTM - A351)	17	400-1133	
	. Hastelloy C276 (CW - 12MW, ASTM - A494)	17	400-1134	
	. Monel 400	17	400-1135	
FLANGE (WITHOUT HOLE FOR DRAIN/VENT)	. Plated CS	17	204-0511	
	. SST 316 CF8M (ASTM - A351)	17	204-0512	
	. Hastelloy C276 (CW - 12MW, ASTM - A494)	17	204-0513	
	. Monel 400	17	204-0514	
BLANK FLANGE (FOR GAGE AND ABSOLUTE MODELS)	. Plated CS	17	204-1101	
	. SST 316 CF8M (ASTM - A351)	17	204-1102	
ADAPTER	. Plated CS	26	203-0601	
	. SST 316	26	203-0602	
	. Hastelloy C276	26	203-0603	
	. Monel 400	26	203-0604	
O-RINGS (NOTE 3)	. Cover, BUNA-N	2	204-0122	B
	. Neck, BUNA-N	20	204-0113	B
	. Flange, BUNA-N	19	203-0401	B
	. Flange, VITON	19	203-0402	B
	. Flange, TEFLON	19	203-0403	B
	. Flange, ETHYLENE/PROPYLENE	19	203-0404	B
	. Flange, TEFLON spring loaded (for models A5, A6, M5, M6, H2, H3, H4 and H5) (NOTE 6)	19	203-0405	B
	. Adapter, BUNA-N	24	203-0701	B
	. Adapter, VITON	24	203-0702	B
	. Adapter, TEFLON	24	203-0703	B
. Adapter, ETHYLENE/PROPYLENE	24	203-0704	B	
BACKUP RING (NOTE 3)		28	203-0710	B
TERMINAL BLOCK INSULATOR SCREW	. HOUSING, Aluminum	14	304-0119	
	. HOUSING, 316 SST	14	204-0119	
MAIN BOARD SCREW FOR HOUSING, Aluminum	. Units With indicator	5	304-0118	
	. Units Without indicator	5	304-0117	
MAIN BOARD SCREW FOR HOUSING, 316 SS	. Units With indicator	5	204-0118	
	. Units Without indicator	5	204-0117	
FLANGE BOLT	. CS	18	203-0300	
	. SST 316	18	203-0310	
FLANGE NUT	. CS	22	203-0302	
	. SST 316	22	203-0312	
ADAPTER BOLT	. CS	25	203-0350	
	. SST 316	25	203-0351	
DRAIN/VENT SCREW	. SST 316	23	203-1401	A
	. Hastelloy C276	23	203-1402	A
	. Monel 400	23	203-1403	A
FLANGE PLUG (STOPPER)	. SST 316	16	203-0552	A
	. Hastelloy C276	16	203-0553	A
	. Monel 400	16	203-0554	A
MOUNTING BRACKET FOR 2" PIPE MOUNTING (NOTE 5)	. CS	-	203-0801	
	. SST 316	-	203-0802	
	. CS with bolts, nuts, washers and U-clamp in 316SS	-	203-0803	
LOCAL ADJUSTMENT PROTECTION CAP		11	204-0114	
SENSOR		27	(NOTE 4)	B

**NOTE**

( 1 ) For category A, it is recommended to keep, in stock, 25 parts installed for each set, and 20 for category B.  
 ( 2 ) Includes Terminal Block, Screws, caps and Identification plate without certification.  
 ( 3 ) O-rings and Backup Rings are packaged in packs of 12 units, except for spring loaded.

( 4 ) To specify sensors, use the following tables.  
 ( 5 ) Including U-Clamp, nuts, bolts and washers  
 ( 6 ) For this type, O-Ring pack has 1 piece.

## Smar Insulator Kit

The Insulator Kit Smar prevents the generation of galvanic current between metals when in contact. The difference of potential between the metals generates this current that flows from the metal with higher potential to the metal with lower potential. This process in the presence of aqueous solution with salts, acids or bases can start the corrosion process, where the corroded metal is always the one with bigger potential (anode).

In the processes, when it is impossible to isolate the two potencialized metals, occurs the generation of galvanic current. This current will form free ions of hydrogen ( $H^+$ ) in one of the solutions, with tendency to start the corrosion and the migration of the Hydrogen to the diaphragm of the Remote Seal or of the Level Transmitter.

The figure 5.5 shows the following parts that constitute the Smar Insulator Kit: Teflon Gasket (6), Nonmetallic Insulating Sleeve (4), Mica Washers (3) and Steel Washers (2).

## Smar Insulator Kit Mounting

Mounting step by step:

- 1 – Insert all the Nonmetallic Insulating Sleeve (4) in the holes of the Sealed Flange (5);
- 2 – Put the Teflon Gasket (6) between the Flanges (5 e 7);
- 3 – Insert the Steel Washers (2) and the Mica Washers (3) in the bolts (1)
- 4 – Join the Flanges positioning its holes (5 and 7);
- 5 – Introduce the bolts in the holes of the flanges (5 and 7) and tighten the flanges with the nuts (8)
- 6 – Measure the resistance between the Sealed Flange (5) and the Flange of Process (7) that should be tending to the infinite to check the efficiency of the Insulator Kit.

**NOTE**

If the studs are used instead of the bolts, obey the same mounting sequence for the items 2, 3 and 4. This Insulator Kit can be applied with raised and flat face flanges. The Gasket must be made of Teflon when the Smar Insulator Kit is indicated.

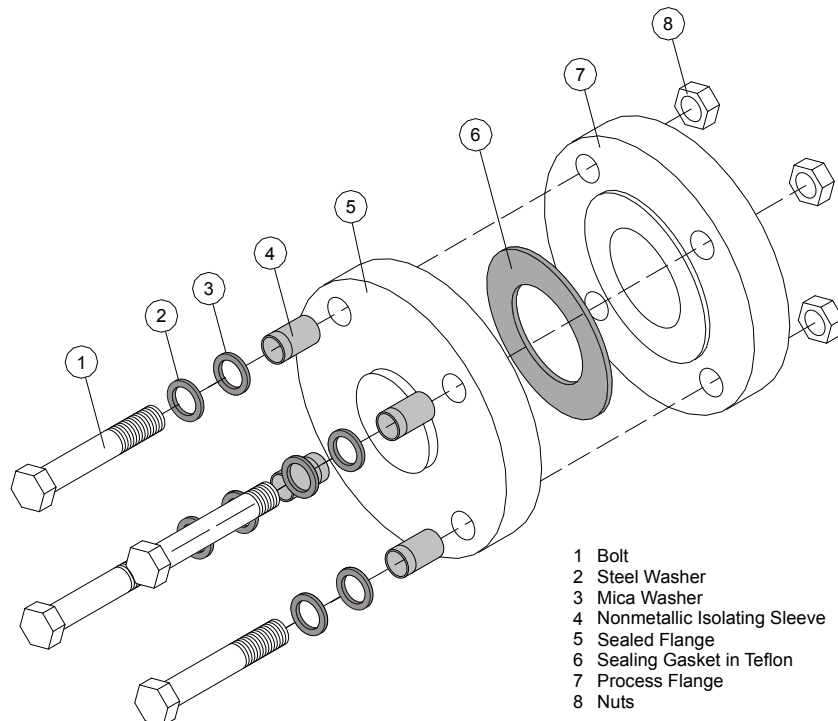

- 1 Bolt
- 2 Steel Washer
- 3 Mica Washer
- 4 Nonmetallic Isolating Sleeve
- 5 Sealed Flange
- 6 Sealing Gasket in Teflon
- 7 Process Flange
- 8 Nuts

Figure 5.5 – Insulator Kit Mounting



INSULATOR KIT SPARE PARTS: LD300L					
ØN	GROUP	NORM	MODELS WITHOUT EXTENSION	MODELS WITH EXTENSION	
			LD300L / SR301T	LD300L / SR301E	
1"	150	ANSI B 16.5	400-0861-11X01	400-0861-11X11	
	300		400-0861-12X01	400-0861-12X11	
	600		400-0861-13X01	400-0861-13X11	
1.1/2"	150		400-0861-21X01	400-0861-21X11	
	300		400-0861-22X01	400-0861-22X11	
	600		400-0861-23X01	400-0861-23X11	
2"	150		400-0861-31X01	400-0861-31X11	
	300		400-0861-32X01	400-0861-32X11	
	600		400-0861-33X01	400-0861-33X11	
3"	150		400-0861-41X01	400-0861-41X11	
	300		400-0861-42X01	400-0861-42X11	
	600		400-0861-43X01	400-0861-43X11	
4"	150		400-0861-51X01	400-0861-51X11	
	300		400-0861-52X01	400-0861-52X11	
	600		400-0861-53X01	400-0861-53X11	
DN25	PN10/40		DIN EN1092-1	400-0861-64X01	400-0861-64X11
DN40	PN10/40			400-0861-74X01	400-0861-74X11
DN50	PN10/40			400-0861-84X01	400-0861-84X11
DN80	PN10/40			400-0861-94X01	400-0861-94X11
DN100	PN16			400-0861-A8X01	400-0861-A8X11
	PN40			400-0861-A4X01	400-0861-A4X11
40A	20K	JIS B 2202	400-0861-B6X01	400-0861-B6X11	
50A	10K		400-0861-C5X01	400-0861-C5X11	
	40K		400-0861-C7X01	400-0861-C7X11	
80A	10K		400-0861-D5X01	400-0861-D5X11	
	20K		400-0861-D6X01	400-0861-D6X11	
100A	10K		400-0861-E5X01	400-0861-E5X11	

**Table 5.2 – LD300L – Codes to the Spare Parts of the Insulator Kit**

See Figure 5.5.

SPARE PARTS: LD300L						
ØN	GROUP	NORM	GASKET			DRAIN VALVE
			TEFLON	COPPER	GRAFOIL	STAINLESS STEEL 316L
1"	ALL	ANSI-B16.5	400-0425	400-0426	400-0427	400-0792
1.1/2"	ALL		400-0428	400-0429	400-0430	
2"	ALL		400-0431	400-0432	400-0433	
3"	ALL		400-0434	400-0435	400-0436	
4"	ALL		400-0437	400-0438	400-0439	
DN25	ALL	EN 1092-1/2501	400-0440	400-0441	400-0442	
DN40	ALL		400-0443	400-0444	400-0445	
DN50	ALL		400-0446	400-0447	400-0448	
DN80	ALL		400-0449	400-0450	400-0451	
DN100	PN10/16		400-0452	400-0453	400-0454	
DN100	PN25/40		400-0455	400-0456	400-0457	

Table 5.3 – LD301L – Codes to the Spare parts of the Gasket

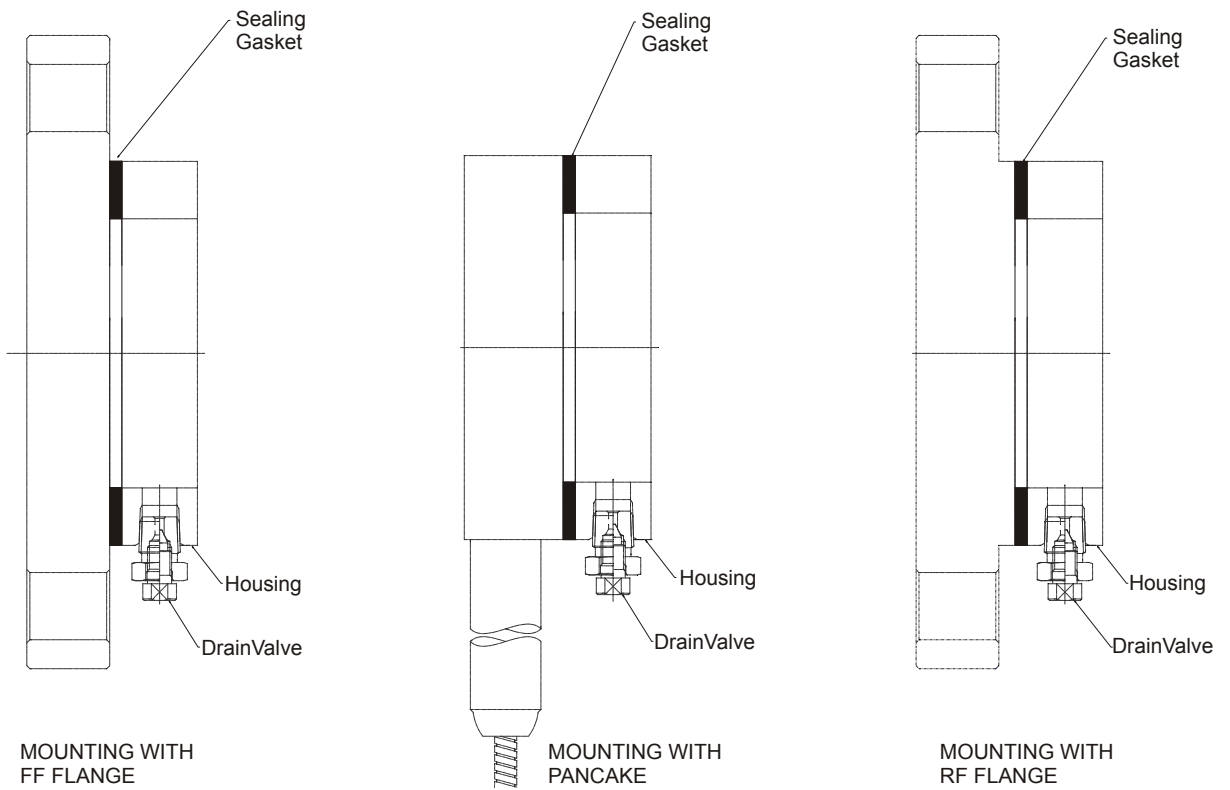

Figure 5.6 – Exploded View - Mounting with Gasket and Drain Valve

RTJ SPARE PARTS: LD300L (without extension)					
ØN	GROUP	NORM	RING	METALLIC RING	DRAIN VALVE
				STAINLESS STEEL 316L	STAINLESS STEEL 316L
1"	150	ANSI B 16.20 RTJ	R15	400-0887	400-0792
	300		R16	400-0888	
	600		R16	400-0888	
	1500		R16	400-0888	
	2500		R18	400-0889	
1.1/2"	150		R19	400-0890	
	300		R20	400-0891	
	600		R20	400-0891	
	1500		R20	400-0891	
	2500		R23	400-0893	
2"	150		R22	400-0892	
	300		R23	400-0893	
	600		R23	400-0893	
	1500		R24	400-0894	
	2500		R26	400-0895	
3"	150		R29	400-0896	
	300		R31	400-0897	
	600		R31	400-0897	
4"	150		R36	400-0900	
	300		R37	400-0901	
	600	R37	400-0901		

Table 5.4 – LD301L – Codes to the SST Metallic O’Ring

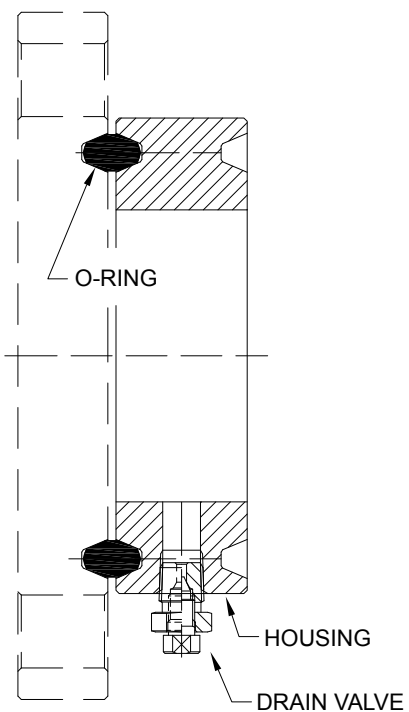

Figure 5.7 – Exploded View of LD300L (without extension)

ØN	CLASS	NORM	Ring	METALLIC RING
				316L SST
3"	1500	ANSI B 16.20 RTJ	R35	400-0899
	2500		R32	400-0898
4"	1500		R39	400-0903
	2500		R38	400-0902

Table 5.5 - LD300L – Special models for Gasket in Steel – Without Extension

## Application with Halar

### Technical Specification

Halar® is chemically one of the most resistant fluoropolymer. It is a thermoplastic of the melting process manufactured by Solvay Solexis, Inc. For its chemical structure, a 1:1 alternating ethylene copolymer and chlorinetrifluoroethylene, Halar® (ECTFE) offers an only combination of useful properties.

The diaphragms in 316L Stainless Steel covered with Halar®, are ideal for applications in contact with aggressive liquids. They offer excellent resistance to the chemic and abrasion with a wide temperature range. Halar® does not contaminate liquids of high purity and it is not affected by most of corrosive chemists, usually found in the industries, including strong minerals, oxidant acids, alkalis, liquid oxygen and some organic solvents.

Halar® is trademark of Solvay Solexis, Inc.

### Performance Specification

For the performance specification see the equation below:

$$[1\% \text{ SPAN} \times (\text{URL}/\text{SPAN})] - \text{Included temperature error}^*$$

Diameters/Capillary Length:

- 2" ANSI B 16.5, DN 50 DIN, JIS 50 A, for seals up to 3 meters of capillary and level models (by inquiry).
- 3" ANSI B 16.5, DN 80 DIN, JIS 80 A, for seals up to 5 meters of capillary and level models.
- 4" ANSI B 16.5, DN 100 DIN, JIS 100 A, for seals up to 8 meters of capillary and level models.

\*Temperature Limits:  
 +10 to 100°C;  
 +101 to 150°C (by inquiry).

## TPE – Total Probable Error (Software)

Software to calculate the assembly error of the Pressure Transmitters with the possible connections to the process.

TPE was developed to a fast and effective aid of the products related the pressure measurement. The users are the Applications Engineer and Commercial Areas. The customer can request a report of performance estimate to Smar.

This product allows doing simulations of possible assemblies, verifying important data as the error estimates of the response time, of capillary length analysis and mechanical resistance of diaphragms with temperature variation. See an example in the Figure 5.8.

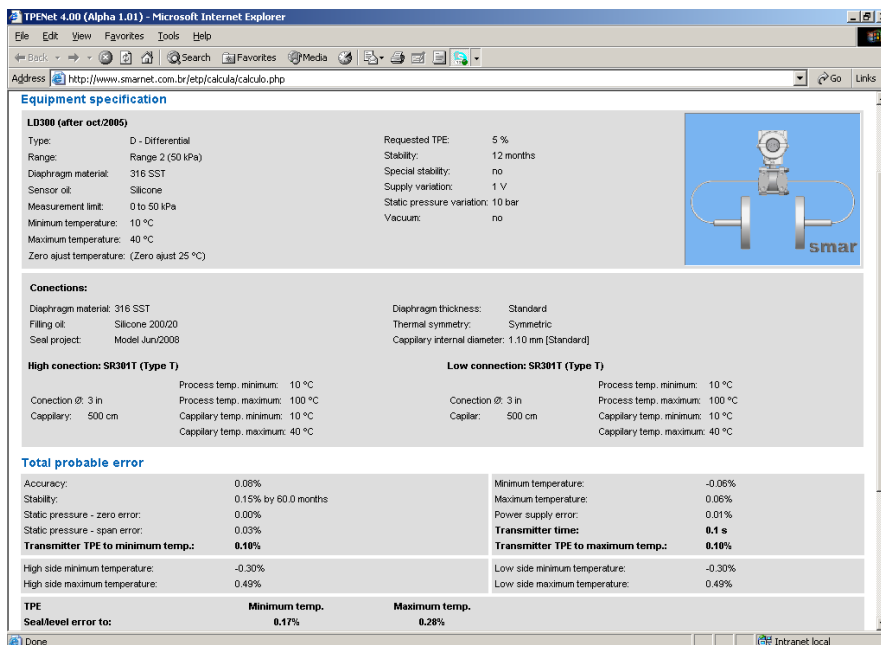

Figure 5.8 – TPE Software Screen

## Ordering Code for the Sensor

204 – 0301 SENSOR FOR DIFFERENTIAL , FLOW, GAGE, ABSOLUTE AND HIGH STATIC PRESSURE TRANSMITTER														
COD	Type	Range Limits		Min. Span	Unit	Range Limits		Min. Span	Unit					
		Min.	Max.			Min.	Max.							
D0	Differential and Flow	-1	1	0.05	kPa	-4	4	0,05	inH <sub>2</sub> O					
D1	Differential and Flow	-5	5	0.13	kPa	-20	20	0,13	inH <sub>2</sub> O					
D2	Differential and Flow	-50	50	0.42	kPa	-200	200	0,42	inH <sub>2</sub> O					
D3	Differential and Flow	-250	250	2.08	kPa	-14,7	36	2,08	psi					
D4	Differential and Flow	-2500	2500	20.83	kPa	-14,7	360	20,83	psi					
M0	Gage	-1	1	0.05	kPa	-4	4	0,05	inH <sub>2</sub> O					
M1	Gage	- 5	5	0.13	kPa	-20	20	0,13	inH <sub>2</sub> O					
M2	Gage	- 50	50	0.42	kPa	-200	200	0,42	inH <sub>2</sub> O					
M3	Gage	-100	250	2.08	kPa	-14,7	36	2,08	psi					
M4	Gage	-100	2500	20.83	kPa	-14,7	360	20,83	psi					
M5	Gage	- 0.1	25	0.21	Mpa	-14,7	3600	0,21	psi					
M6	Gage	- 0.1	40	0.33	Mpa	-14,7	5800	0,33	psi					
A1	Absolute	0	5	2.00	kPa	0	20	2,00	inH <sub>2</sub> O					
A2	Absolute	0	50	2.50	kPa	0	200	2,50	inH <sub>2</sub> O					
A3	Absolute	0	250	5.00	kPa	0	36	5,00	psi					
A4	Absolute	0	2500	20.83	kPa	0	360	20,83	psi					
A5	Absolute	0	25	0.21	Mpa	0	3600	0,21	psi					
A6	Absolute	0	40	0.33	Mpa	0	5800	0,33	psi					
H2	Differential – High Static Pressure	-50	50	0.42	kPa	-200	200	0,42	inH <sub>2</sub> O					
H3	Differential – High Static Pressure	-250	250	2.08	kPa	-14,7	36	2,08	psi					
H4	Differential – High Static Pressure	-2500	2500	20.83	kPa	-14,7	360	20,83	psi					
H5	Differential – High Static Pressure	-25	25	0.21	Mpa	-14,7	3600	0,21	psi					
<b>COD. Diaphragm Material and Fill Fluid</b>														
1	316 SST	Silicone Oil (4)			8	Tantalum	Inert Oil Fluorolube (2)(3)(5)			K	Monel 400	Inert Oil Krytox (1) (3) (5)		
2	316 SST	Inert Oil Fluorolube (2) (5)			9	316L SST	Fomblim Oil			M	Monel 400 Gold Plated	Silicone Oil (1) (3) (4)		
3	Hastelloy C276	Silicone Oil (1) (4)			A	Monel 400	Fomblim Oil (1) (3)			P	Monel 400 Gold Plated	Inert Oil Krytox (1) (3) (5)		
4	Hastelloy C276	Inert Oil Fluorolube (1)(2)(5)			D	316L SST	Inert Oil Krytox (3) (5)			Q	316 SST	Inert Oil Halocarbon 4.2 (2) (3) (5)		
5	Monel 400	Silicone Oil (1) (3) (4)			E	Hastelloy C276	Inert Oil Krytox (1) (3) (5)			R	Hastelloy C276	Inert Oil Halocarbon 4.2 (2) (3) (5)		
7	Tantalum	Silicone Oil (3) (4)			G	Tantalum	Inert Oil Krytox (3) (5)			S	Tantalum	Inert Oil Halocarbon 4.2 (2) (3) (5)		

204 – 0301

D2

1

← TYPICAL MODEL NUMBER

### NOTES

- (1) Meets NACE MR – 01 – 75/ISO 15156 recommendations.
- (2) Not available for absolute models nor for vacuum applications.
- (3) Not available for range 0 and 1.
- (4) Silicone Oil is not recommended for oxygen (O<sub>2</sub>) or Chlorine service.
- (5) Inert Fluid: Oxygen Compatibility, safe for oxygen service.

**LD301 - Operation and Maintenance Instruction Manual**

204-0301 SENSOR FOR FLANGED PRESSURE TRANSMITTER										
COD.	Range Limits		Min. Span	Unit	Range limits		Min. Span	Unit	<p><b>Note:</b> The range can be extended up to 0.75 LRL and 1.2 URL with small degradation of accuracy. The upper range value must be limited to the flange rating.</p>	
	Min.	Max.			Min.	Max.				
L2	-50	50	1.25	kPa	-200	200	0.42	inH <sub>2</sub> O		
L3	-250	250	2.08	kPa	-14.7	36	2.08	psi		
L4	-2500	2500	20.83	kPa	-14.7	360	20.83	psi		
L5	-25000	25000	208.3	kPa	-14.7	3600	0.21	psi		
COD. Diaphragm material and Fill Fluid (Low Side)										
1	316L SST	Silicone Oil (2)		D	316L SST	Inert Oil Krytox (21)				
2	316L SST	Inert Oil Fluorolube (3) (21)		E	Hastelloy C276	Inert Oil Krytox (1) (21)				
3	Hastelloy C276	Silicone Oil (1) (2)		G	Tantalum	Inert Oil Krytox (21)				
4	Hastelloy C276	Inert Oil Fluorolube(1)(3)(21)		K	Monel 400	Inert Oil Krytox (1) (21)				
5	Monel 400	Silicone Oil (1) (2)		M	Monel 400 Gold Plated	Silicone Oil (1) (2)				
7	Tantalum	Silicone Oil (2)		P	Monel 400 Gold Plated	Inert Oil Krytox (1) (21)				
8	Tantalum	Inert Oil Fluorolube (3) (21)		Q	316L SST	Inert Oil Halocarbon 4.2 (21)				
9	316L SST	Fomblim Oil		R	Hastelloy C276	Inert Oil Halocarbon 4.2 (1) (21)				
A	Monel 400	Fomblim Oil (1)		S	Tantalum	Inert Oil Halocarbon 4.2 (21)				
COD. Flange, Adapter and Drain/Vent Valves material (Low Side)										
A	304L SST			M	Monel 400 (1)					
C	Plated CS (Drain/Vent in Stainless Steel) (22)			N	316 SST – CF8M (ASTM – A351) (Drain/Vent in Hastelloy C276) (1)					
H	Hastelloy C276 (CW – 12MW, ASTM – A494) (1)			P	316 SST – CF8M (ASTM – A351) Flange with PVDF (Kynar) insert (3) (4) (5)					
I	316 SST – CF8M (ASTM – A351)									
COD. Wetted O'Ring Material (Low Side)										
0	Without O'Rings		K	Kalrez						
B	Buna-N		T	Teflon					<b>Note:</b> O'rings are not available on the sides with remote seals.	
E	Ethylene – Propylene		V	Viton						
COD. Drain/Vent Position (Low Side)										
0	Without Drain/Vent		D	Bottom					<b>Note:</b> For better Drain/Vent operation, vent valves are strongly recommended.	
A	Drain/Vent (Opposite to Process Connection)		U	Top					Drain/Vent valve not available on the sides with remote seals.	
COD. Process Connection (Low Side)										
0	1/2 - 18 NPT (Without Adapter)		5	1/2 - 14 NPT Axial with PVDF Insert (3) (4) (6)		U		Low Volume Flange For Level Welded		
1	1/2 - 14 NPT (Without Adapter)		9	Remote Seal (Low Volume Flange) (3) (7)		V		Without Connection (Mounting With Gage Flange)		
3	Remote Seal (With Plug) (7)		T	1/2 14 BSP (With Adapter)		W		Without Connection (Absolut Reference)		
COD. Process Connection (Level tap)										
U	1" 150 # (ANSI B16.5) (24)		C	3" 600 # (ANSI B16.5)		S		JIS 40A 20K (23)		
V	1" 300 # (ANSI B16.5) (24)		N	3" 600 # (ANSI B16.5 RTJ)		F		JIS 50A 10K (23)		
W	1" 600 # (ANSI B16.5) (24)		3	4" 150 # (ANSI B16.5)		T		JIS 50A 40K (23)		
O	1.1/2" 150 # (ANSI B16.5)		4	4" 300 # (ANSI B16.5)		K		JIS 50A 20K (23)		
P	1.1/2" 300 # (ANSI B16.5)		D	4" 600 # (ANSI B16.5)		G		JIS 80A 10K (23)		
Q	1.1/2" 600 # (ANSI B16.5)		5	DN 25 PN 10/40 (24)		L		JIS 80A 20K (23)		
9	2" 150 # (ANSI B16.5)		R	DN 40 PN 10/40		H		JIS 100A 10K (23)		
A	2" 300 # (ANSI B16.5)		E	DN 50 PN 10/40		M		JIS 100A 10K (23)		
B	2" 600 # (ANSI B16.5)		6	DN 80 PN 10/40		Z		User's specification		
1	3" 150 # (ANSI B16.5)		7	DN 100 PN 10/16						
2	3" 300 # (ANSI B16.5)		8	DN 100 PN 25/40						
COD. Type and Flange Material ( Level Tap)										
2	316 SST (Integral Flange)		4	304 SST (Slip-on Flange)		6		Carbon Steel (Slip-on Flange)		
3	Hastelloy C276 (Integral Flange)		5	316 SST (Slip-on Flange)		Z		User's specification		
COD. Extension Length										
0	0 mm (0")		3	150 mm (6")						
1	50 mm (2")		4	200 mm (8")				<b>Note:</b> Extension Material 316 SST		
2	100 mm (4")		Z	User's specification						
COD. Diaphragm Material / Extension (Level Tap)										
A	304L SST / 304L SST		6	316L SST with Teflon Lining (For 2" and 3")						
1	316L SST / 316 SST		7	316L SST Gold Plated						
2	Hastelloy C276 / 316 SST		B	Tantalum with Teflon Lining						
3	Monel 400 / 316 SST		L	316L SST Halar Plated (20)						
4	Tantalum / 316 SST (10)		C	Hastelloy Teflon Plated						
5	Titanium / 316 SST (10)									
COD. Fill Fluid										
1	DC – 200/20 Silicone Oil		G	Glycerin + water (11)						
3	DC704 Silicone Oil		B	Fomblim 06/06						
2	MO – 10 Fluorolube Oil (8)		H	Halocarbon 4.2						
4	Krytox Oil		T	Syltherm 800 Oil						
N	Neobee M20 Propylene Glycol Oil									
COD. Lower Housing Material										
0	Without Lower Housing (12)									
1	316 SST									
2	Hastelloy C276									
3	Super Duplex (UNS 32750) (11)									
4	Duplex (UNS 31803) (11)									
5	304L SST (11)									
COD. Gasket Material										
0	Without Gasket									
T	Teflon (Ptfе)									
G	Grafoil (Flexible lead)									
C	Copper									
I	316 L SST									

204-0301 L2 1 I B U 0 1 2 2 1 1 1 1 T ← TYPICAL MODEL NUMBER

204-0301		SENSOR FOR FLANGED PRESSURE TRANSMITTER (CONTINUATION)	
<b>CODE</b>		<b>Flanges Bolts and Nuts Material</b>	
A0	Plated Carbon Steel (Default) (22)	A5	Hastelloy C276
A1	316 SST		
A2	Carbon Steel (ASTM A193 B7M) (1) (22)		
<b>CODE</b>		<b>Flange thread for Fixing Accessories (Adapters, Manifolds, Mounting Brackets, etc)</b>	
D0	7/16" UNF (Default)	D2	M12 X 1.75
D1	M10 X 1.5		
<b>CODE</b>		<b>Flange Facing Finish</b>	
Q0	Raised Face – RF (Default)		
Q1	Flat Face – FF		
Q2	Ring Joint Face – RTJ (Only available for ANSI standard flange) (17)		
Q3	Tongue Face (11)		
Q4	Grooved Face (11)		

204-0301 A0 D0 Q0 ← TYPICAL MODEL NUMBER

## NOTES

- (1) Meets NACE MR – 01 – 75/ISO 15156 recommendations.
- (2) Silicone Oils not recommendations for Oxygen (O<sub>2</sub>) or Chlorine service.
- (3) Not applicable for vacuum service.
- (4) Drain/Vent not applicable.
- (5) O'Ring should be Viton or Kalrez.
- (6) Maximum pressure 24 bar.
- (7) For remote Seal only 316 SST - CF8M (ASTM A3510 flange is available (thread M12).
- (8) Fluorolube fill fluid is not available for Monel diaphragm.
- (9) Options not certified for hazardous locations.
- (10) Attention, check corrosion rate for the process, tantalum plate 0.1 mm, AISI 316L extension 3 to 6mm.
- (11) Item by inquiry.
- (12) Supplied without Gasket.
- (13) Without certification for Explosion proof certification or Intrinsically safe.
- (14) Limited values to 4 1/2 digits; limited unit to 5 characters.
- (15) Degreaser's cleaning is not available for carbon steel flanges
- (16) The insulator kit is applicable with Raised Face (H0) and Smooth Face (H1) with Gasket material.  
T(Teflon) and only for the following models:  
- For models with extension the Gasket T (Teflon) it has special share.
- (17) Gasket for housing, available only in Stainless 316.
- (18) Finishing flange faces:  
ANSI B 16.5 / MSS-SP6:  
- Raised or Smooth Face with gooved lining: 3.2 to 6.3 µm Ra (125 a 250 µ" AA);  
- Small or Large Tongue Face and Small or Large Groove with smooth finishing not exceeding: 3.2 µm Rt (125 µ" AA);
- RTJ ANSI B 16.20 / MSS-SP6:  
- Smooth finishing not exceeding: 1.6 µm Rt (63 µ" AA);  
DIN EN-1092-1:  
- Grooved finishing "B1" (PN 10 a PN40): 3.2 a 12.5 µm Ra (125 a 500 µ" AA);  
- Smooth finishing "B2" (PN 63 a PN100), "C" (Tongue) e "D" (Groove): 0.8 a 3.2 µm Ra (32 a 125 µ" AA).  
Din 2501 (DIN 2526):  
- Smooth finishing "E" (PN 160 a PN250): Rz = 16 (3.2 µm Ra (125 µ" AA).  
Standard Jis B2201  
- Grooved finishing 3.2 a 6.3 µm Ra (125 a 250 µ" AA).  
(19) Range of application of temperature from -40 °C to 150 °C.  
(20) Applicable only to:  
- Thickness of steel: 0.05 mm  
- Diameter/capillary length:  
2" ANSI B 16.5 DN 50 DIN, JIS 50 A, for seals up to 3 meters of capillary and level models (by inquiry).  
3" ANSI B 16.5 DN 80 DIN, JIS 80 A, for seals up to 5 meters of capillary and level models.  
- Faces: RF and FF;  
- Temperature Range: +10 to 100 °C  
+ 101 to 150 °C (by inquiry)  
- Not applicable for diaphragm thickness;  
- Not applicable for use with gaskets.  
(21) Inert Fluid: Oxygen Compatibility, safe for oxygen service.  
(22) Not applicable for saline atmosphere.  
(23) Not available for slip-on flange.  
(24) Not available for integral flange.

**LD301 - Operation and Maintenance Instruction Manual**

204-0301 SENSOR FOR SANITARY PRESSURE TRANSMITTER										
COD.	Range Limits		Min. Span	Unit	Range		Min. Span	Unit		
	Min.	Max.			Min.	Max.				
S2	-50	50	1.25	kPa	-200	200	0,42	inH <sub>2</sub> O	<b>Note:</b> The range can be extended up to 0.75 LRL and 1.2 URL with small degradation of accuracy. The upper range value must be limited to the flange rating.	
S3	-250	250	2.08	kPa	-14,7	36	2,08	psi		
S4	-2500	2500	20.83	kPa	-14,7	360	20,83	psi		
S5	-25000	25000	208.3	kPa	-14,7	3600	0,21	psi		
COD. Diaphragm Material and Fill Fluid (Low Side)										
1	316L SST	Silicone Oil (2)		D	316L SST	Inert Oil Krytox (12)				
2	316L SST	Inert Oil Fluorolube (3) (12)		E	Hastelloy C276	Inert Oil Krytox (1) (12)				
3	Hastelloy C276	Silicone Oil (1) (2)		G	Tantalum	Inert Oil Krytox (12)				
4	Hastelloy C276	Inert Oil Fluorolube(1)(3)(12)		K	Monel 400	Inert Oil Krytox (1) (12)				
5	Monel 400	Silicone Oil (1) (2)		M	Monel 400 Gold Plated	Silicone Oil (1) (2)				
7	Tantalum	Silicone Oil (2)		P	Monel 400 Gold Plated	Inert Oil Krytox (1) (12)				
8	Tantalum	Inert Oil Fluorolube (3) (12)		Q	316L SST	Inert Oil Halocarbon 4.2 (12)				
9	316L SST	Fomblim Oil		R	Hastelloy C276	Inert Oil Halocarbon 4.2 (1) (12)				
A	Monel 400	Fomblim Oil (1)		S	Tantalum	Inert Oil Halocarbon 4.2 (12)				
COD. Flange, Adapter and Drain/Vent Valves Material (Low Side)										
C	Plated CS (Drain/Vent in Stainless Steel) (13)				M	Monel 400 (1)				
H	Hastelloy C276 (CW – 12MW, ASTM – A494) (1)				N	316 SST – CF8M (ASTM – A351) (Drain/Vent in Hastelloy C276) (1)				
I	316 SST – CF8M (ASTM – A351)				P	316 SST – CF8M (ASTM – A351) Flange with PVDF (Kynar) insert (3) (4) (5)				
COD. Wetted O'Ring Material (Low Side)										
0	Without O'Rings			K	Kalrez			<b>Note:</b> O'rings are not available on the sides with remote seals.		
B	Buna N			T	Teflon					
E	Ethylene – Propylene			V	Viton					
COD. Drain/Vent Position (Low Side)										
0	Without Drain/Vent				D	Bottom				
A	Drain/Vent (Opposite to Process Connection)				U	Top				
<b>Note:</b> For better Drain/Vent operation, vent valves are strongly recommended. Drain/Vent valve not available on the sides with remote seals.										
COD. Process Connection (Low Side)										
0	¼ - 18 NPT (Without Adapter)			5	1/2 - 14 NPT Axial with PVDF Insert (3) (4) (6)			U	Low Volume Flange For Level Welded	
1	1/2 - 14 NPT (Without Adapter)			9	Remote Seal (Low Volume Flange) (3) (7)			V	Without Connection (Mounting With Gage Flange)	
3	Remote Seal (With Plug) (7)			T	1/2 14 BSP (With Adapter)			W	Without Connection (Absolut Reference)	
COD. Process Connection (Level tap)										
8	Threaded DN25 DIN 11851 – with extension / 316L SST (9)(10)				E	Threaded SMS 2" – without extension / 316L SST (9) (10)				
9	Threaded DN40 DIN 11851 - with extension / 316L SST (9)(10)				M	Threaded SMS 3" - with extension / 316L SST (9) (10)				
H	Threaded DN40 DIN 11851 – without extension / 316L SST (9)				1	Threaded SMS 3" - without extension / 316L SST (9) (10)				
V	Threaded DN50 DIN 11851 - with extension / 316L SST (9)(10)				F	Tri-Clamp 1 1/2" – without extension / 316L SST (10)				
U	Threaded DN50 DIN 11851 - without extension / 316L SST (9)				Q	Tri-Clamp 1 1/2" HP (High Pressure) - without extension / 316L SST n (8) (10)				
X	Threaded DN80 DIN 11851 - with extension / 316L SST (9)(10)				6	Tri-Clamp 2" - with extension / 316L SST (10)				
W	Threaded DN80 DIN 11851 - without extension / 316L SST (9)				D	Tri-Clamp 2" – without extension / 316L SST (10)				
4	Threaded IDF 2" - with extension / 316L SST (9) (10)				N	Tri-Clamp 2" HP (High Pressure) - with extension / 316L SST (8) (10)				
B	Threaded IDF 2" – without extension / 316L SST (9) (10)				P	Tri-Clamp 2" HP (High Pressure) – without extension / 316L SST (8) (10)				
K	Threaded IDF 3" - with extension / 316L SST (9) (10)				I	Tri-Clamp 3" - with extension / 316L SST (10)				
3	Threaded IDF 3" - without extension / 316L SST (9) (10)				G	Tri-Clamp 3" – without extension / 316L SST (10)				
5	Threaded RJT 2" - with extension / 316L SST (9) (10)				J	Tri-Clamp 3" HP (High Pressure) - with extension / 316L SST (8) (10)				
C	Threaded RJT 2" - without extension / 316L SST (9)				R	Tri-Clamp 3" HP (High Pressure) – without extension o (8) (10)				
L	Threaded RJT 3" - with extension / 316L SST (9) (10)				Z	User's specification				
2	Threaded RTJ 3" - without extension / 316L SST (9)									
S	Threaded SMS 1 1/2" – without extension / 316L SST (9) (10)									
7	Threaded SMS 2" - with extension / 316L SST (9) (10)									
COD. Diaphragm Material (Level Tap)										
1	316L SST				6	316L SST with Teflon Lining (For 2"and 3")				
2	Hastelloy C276				7	316L SST Gold Plated				
3	Monel 400				B	Tantalum with Teflon Lining				
4	Tantalum (11)				L	316L SST Halar Plated (20)				
5	Titanium (11)				C	Hastelloy Teflon Plated				
COD. Fill Fluid										
1	DC – 200/20 Silicone Oil				G	Glycerin + water (11)				
3	DC704 Silicone Oil				B	Fomblim 06/06				
2	MO – 10 Fluorolube Oil (8)				H	Halocarbon 4.2				
4	Krytox Oil				T	Syltherm 800 Oil				
N	Neobee M20 Propylene Glycol Oil (Approved 3A) (10)									

204-0301 L2 1 I B U 0 1 2 2 ← TYPICAL MODEL NUMBER



204-0301		SENSOR FOR SANITARY PRESSURE TRANSMITTER (CONTINUATION)	
CODE		Flanges Bolts and Nuts Material	
A0	Plated Carbon Steel (Default) (13)	A5	Hastelloy C276
A1	316 SST		
A2	Carbon Steel (ASTM A193 B7M) (1) (13)		
CODE		Flange Thread for Fixing Accessories (Adapters, Manifolds, Mounting Brackets, etc)	
D0	7/16" UNF (Default)	D2	M12 X 1.75
D1	M10 X 1.5		

204-0301 A0 D0 ← TYPICAL MODEL NUMBER

**NOTES**

- ( 1 ) Meets NACE MR – 01 – 75/ISO 15156 recommendations.
- ( 2 ) Silicone Oils not recommendations for Oxygen (O<sub>2</sub>) or Chlorine service.
- ( 3 ) Not applicable for vacuum service.
- ( 4 ) Drain/Vent not applicable.
- ( 5 ) O'Ring should be Viton or Kalrez.
- ( 6 ) Maximum pressure 24 bar.
- ( 7 ) For remote Seal only 316 SST - CF8M (ASTM A3510 flange is available (thread M12).
- ( 8 ) HP – High Pressure
- ( 9 ) Not available for tri-clamp connections.
- (10) Compliant with 3A-7403 standard for food and other applications where sanitary connections are required:
  - Neobee M2O Fill Fluid
  - Finishing wet Face: 0.8 μm Ra (32 μ" AA)
  - Wet O-Ring: Viton, Buna-N and Teflon
- (11) Item by inquire.
- (12) Inert Fluid: safe for oxygen service.
- (13) Not applicable for saline atmosphere.

## HART<sup>®</sup> Special Units

VARIABLE	CODE	UNIT	DESCRIPTION
PRESSURE	1	inH <sub>2</sub> O (68°F)	inches of water at 68 degrees F
	2	inHg (0°C)	inches of mercury at 0 degrees C
	3	ftH <sub>2</sub> O (68°F)	feet of water at 68 degrees F
	4	mmH <sub>2</sub> O (68°F)	millimeters of water at 68 degrees F
	5	mmHg (0°C)	millimeters of mercury at 0 degrees C
	6	lb/in <sup>2</sup>	pounds per square inch
	7	bar	bars
	8	mbar	millibars
	9	gf/cm <sup>2</sup>	Gram force per square centimeter
	10	kgf/cm <sup>2</sup>	Kilogram force per square centimeter
	11	Pa	pascals
	12	kPa	kilopascals
	13	torr	torr
	14	atm	atmospheres
	145	inH <sub>2</sub> O (60°F)	inches of water at 60 degrees F
237	MPa	megapascals	
238	inH <sub>2</sub> O (4°C)	inches of water at 4 degrees C	
239	mmH <sub>2</sub> O (4°C)	millimeters of water at 4 degrees C	
VOLUMETRIC FLOW	15	CFM	cubic feet per minute
	16	GPM	gallons per minute
	17	l/min	liters per minute
	18	ImpGal/min	imperial gallons per minute
	19	m <sup>3</sup> /h	cubic meters per hour
	22	gal/s	gallons per second
	23	Mgal/d	million gallons per day
	24	l/s	liters per second
	25	Ml/d	million liters per day
	26	ft <sup>3</sup> /s	cubic feet per second
	27	ft <sup>3</sup> /d	cubic feet per day
	28	m <sup>3</sup> /s	cubic meters per second
	29	m <sup>3</sup> /d	cubic meters per day
	30	ImpGal/h	imperial gallons per hour
	31	ImpGal/d	imperial gallons per day
	121	Nm <sup>3</sup> /h	normal cubic meters per hour
	122	Nl/h	normal liters per hour
	123	ft <sup>3</sup> /min	standard cubic feet per minute
	130	CFH	cubic feet per hour
	131	m <sup>3</sup> /h	cubic meters per hour
	132	bbl/s	barrels per second
	133	bbl/min	barrels per minute
	134	bbl/h	barrels per hour
	135	bbl/d	barrels per day
	136	gal/h	gallons per hour
137	ImpGal/s	imperial gallons per second	
138	l/h	liters per hour	
235	gal/d	gallons per day	

VARIABLE	CODE	UNIT	DESCRIPTION
VELOCITY	20	ft/s	feet per second
	21	m/s	meters per second
	114	in/s	inches per second
	115	in/min	inches per minute
	116	ft/min	feet per minute
	120	m/h	meters per hour
TEMPERATURE	32	°C	degrees Celsius
	33	°F	degrees Fahrenheit
	34	°R	degrees Rankine
	35	K	degrees Kelvin
ELECTRO MAGNETIC FORCE	36	mV	millivolts
	58	V	volts
ELECTRIC RESISTANCE	37	ohm	ohms
	163	kohm	kilo ohms
ELECTRIC CURRENT	39	mA	milliamperes
VOLUME	40	gal	gallons
	41	l	liters
	42	ImpGal	imperial gallons
	43	m <sup>3</sup>	cubic meters
	46	bbl	barrels
	110	bushel	bushels
	111	yd <sup>3</sup>	cubic yards
	112	ft <sup>3</sup>	cubic feet
	113	in <sup>3</sup>	cubic inches
	124	bbl(liq)	liquid barrels
	166	Nm <sup>3</sup>	normal cubic meter
	167	Nl	normal liter
	168	SCF	standard cubic feet
	236	hl	hectoliters
LENGTH	44	ft	feet
	45	m	meters
	47	in	inches
	48	cm	centimeters
	49	mm	millimeters
	151	ftin <sup>16</sup>	feet in sixteenths
	TIME	50	min
51		s	seconds
52		h	hours
53		d	days
MASS	60	g	grams
	61	kg	kilograms
	62	t	metric tons
	63	lb	pounds
	64	Shton	short tons (2000 pounds)
	65	Lton	long tons (2240 pounds)
	125	oz	ounce

VARIABLE	CODE	UNIT	DESCRIPTION
VISCOSITY	54	cSt	centistokes
	55	cP	centipoises
ENERGY (INCLUDES WORK)	69	N-m	newton meter
	89	decatherm	deka therm
	126	ft-lb	foot pound force
	128	KWH	kilo watt hour
	162	Mcal	mega calorie
	164	MJ	mega joule
	165	Btu	british thermal unit
MASS FLOW	70	g/s	grams per second
	71	g/min	grams per minute
	72	g/h	grams per hour
	73	kg/s	kilograms per second
	74	kg/min	kilograms per minute
	75	kg/h	kilograms per hour
	76	kg/d	kilograms per day
	77	t/min	metric tons per minute
	78	t/h	metric tons per hour
	79	t/d	metric tons per day
	80	lb/s	pounds per second
	81	lb/min	pounds per minute
	82	lb/h	pounds per hour
	83	lb/d	pounds per day
	84	Shton/min	short tons per minute
	85	Shton/h	short tons per hour
	86	Lton/d	short tons per day
	87	Lton/h	long tons per hour
88	Lton/d	long tons per day	
MASS PER VOLUME	90	SGU	specific gravity units
	91	g/cm <sup>3</sup>	grams per cubic centimeter
	92	kg/m <sup>3</sup>	kilograms per cubic meter
	93	lb/gal	pounds per gallon
	94	lb/ft <sup>3</sup>	pounds per cubic foot
	95	g/ml	grams per milliliter
	96	kg/l	kilograms per liter
	97	g/l	grams per liter
	98	lb/in <sup>3</sup>	pounds per cubic inch
	99	ton/yd <sup>3</sup>	short tons per cubic yard
	100	degTwad	degrees twaddell
	102	degBaum hv	degrees Baume heavy
	103	degBaum lt	degrees Baume light
	104	deg API	degrees API
	146	µg/l	micrograms per liter
147	µg/m <sup>3</sup>	micrograms per cubic meter	
148	%Cs	percent consistency	

VARIABLE	CODE	UNIT	DESCRIPTION
ANGULAR VELOCITY	117	°/s	degrees per second
	118	rev/s	revolutions per second
	119	RPM	revolutions per minute
POWER	127	kW	kilo watt
	129	hp	horsepower
	140	Mcal/h	mega calorie per hour
	141	MJ/h	mega joule per hour
	142	Btu/h	British thermal unit per hour
MISCELLANEOUS	38	Hz	hertz
	56	µS	micro siemens
	57	%	percent
	59	pH	pH
	66	mS/cm	milli siemens per centimeter
	67	µS/cm	micro siemens per centimeter
	68	N	newton
	101	degbrix	degrees brix
	105	%sol/wt	percent solids per weight
	106	%sol/vol	percent solids per volume
	107	degBall	degrees balling
	108	proof/vol	proof per volume
	109	proof/mass	proof per mass
	139	ppm	parts per million
	143	°	degrees
	144	rad	radian
	149	%vol	volume percent
	150	%stm qual	percent steam quality
	152	ft <sup>3</sup> /lb	cubic feet per pound
	153	pF	picofarads
	154	ml/l	milliliters per liter
	155	µl/l	microliters per liter
	160	% plato	percent plato
161	LEL	percent lower explosion level	
169	ppb	parts per billion	
GENERIC	240 to 249	-	May be used for manufacturer specific definitions
	250	-	Not Used
	251	-	None
	252	-	Unknown
	253	-	Special

**Note:** Information extracted from HART<sup>®</sup> Protocol Specification.



# Section 6

## TECHNICAL CHARACTERISTICS

Functional Specifications	
<b>Process Fluid</b>	Liquid, gas or steam.
<b>Output</b>	Two-wire, 4 - 20 mA controlled according to NAMUR NE-43 specification, with superimposed digital communication (HART® Protocol).
<b>Power Supply</b>	12 to 45 Vdc.  <b>Transient Suppressor</b> $V_{max} = 65V$ pick; Differential mode - bi-directional; Low current leak and capacitance; meets the standards: IEEE61000-4-4 and IEEE61000-4-5; Less than 5 ns response time.
<b>Indicator</b>	4 1/2 -digit numerical and 5-character alphanumeric LCD indicator (optional).
<b>Hazardous Area Certifications</b>	Intrinsically Safe (FM, CSA, NEMKO, EXAM, CEPEL, NEPSI), explosion proof (FM, CSA, NEMKO, CEPEL, NEPSI), dust ignition proof (FM) and non-incendive (FM).
<b>European Directive Information</b>	<p><b>Authorized representative in European Community</b> Smar GmbH-Rheingaustrasse 9-55545 Bad Kreuznach</p> <p><b>PED Directive (97/23/EC) – Pressure Equipment Directive</b> This product is in compliance with the directive and it was designed and manufactured in accordance with sound engineering practice using several standards from ANSI, ASTM, DIN and JIS.</p> <p><b>EMC Directive (2004/108/EC) - Eletromagnetic Compatibility</b> The EMC test was performed according to IEC standard: IEC61326-1:2006, IEC61326-2-3:2006, IEC61000-6-4:2006, IEC61000-6-2:2005. For use in environment only. Keep the shield insulated at the instrument side, connecting the other one to the ground if necessary to use shielded cable.</p> <p><b>ATEX Directive (94/9/EC) – Equipment and protective systems intended for use in potentially explosive atmospheres</b> This product was certified according European Standards at NEMKO and EXAM (old DMT). The certified body for manufacturing quality assessment is EXAM (number 0158).</p> <p><b>LVD Directive 2006/95/EC – Electrical Equipment designed for use within certain voltage limits</b> According the LVD directive Annex II the equipment under ATEX “Electrical equipment for use in an explosive atmosphere” directive are excluded from scope from this directive.  The EC declarations of conformity for all applicable European directives for this product can be found at <a href="http://www.smar.com">www.smar.com</a>.</p>
<b>Zero and Span Adjustments and Local Adjustment</b>	No interactive, via digital communication. Jumper local adjustment with three positions: simple, disable, and complete.
<b>Load Limitation</b>	<p>Operating area</p> <p>Load (Ohm)</p> <p>Power Supply (Volt)</p> <p>4-20mA and digital communication</p> <p>4-20mA only</p>

<b>Functional Specifications</b>																																																			
<b>Failure Alarm (Diagnostics)</b>	<p>In case of sensor or circuit failure, the self-diagnostics drives the output to 3.6 or 21.0 mA, according to the user's choice and NAMUR NE43 specification. Detailed diagnostic through HART<sup>®</sup> communication.</p> <p>The graph plots Output Current (mA) on the y-axis (3.6 to 21.0) against Pressure (%) on the x-axis (-1.25% to 103.25%). A linear 'Set Range' is shown between 0% and 100%. Regions above 20.5 mA and below 3.8 mA are labeled 'Failure'. Regions between 20.0-20.5 mA and 3.6-3.8 mA are labeled 'Saturated'. Vertical lines indicate 'Minimum Detected Pressure' at -1.25% and 'Maximum Detected Pressure' at 103.25%.</p>																																																		
<b>Temperature Limits</b>	<table border="0"> <tr> <td>Ambient:</td> <td>-40</td> <td>a</td> <td>85 °C</td> <td>(-40 a 185 °F)</td> </tr> <tr> <td>Process:</td> <td>-40</td> <td>a</td> <td>100 °C</td> <td>(-40 a 212 °F) (Silicone oil)</td> </tr> <tr> <td></td> <td>-40</td> <td>a</td> <td>85 °C</td> <td>(-40 a 185 °F) (Halocarbon and Inert oil)</td> </tr> <tr> <td></td> <td>0</td> <td>a</td> <td>85 °C</td> <td>(32 a 185 °F) (Inert oil)</td> </tr> <tr> <td></td> <td>-20</td> <td>a</td> <td>85 °C</td> <td>(-4 a 185 °F) (Inert Krytox Oil and Fomblim oil)</td> </tr> <tr> <td></td> <td>-25</td> <td>a</td> <td>100 °C</td> <td>(-13 a 212 °F) (Viton O'ring)</td> </tr> <tr> <td></td> <td>-40</td> <td>a</td> <td>150 °C</td> <td>(-40 a 302 °F) (Level Model)</td> </tr> <tr> <td>Storage:</td> <td>-40</td> <td>a</td> <td>100 °C</td> <td>(-40 a 212 °F)</td> </tr> <tr> <td>Display:</td> <td>-20</td> <td>a</td> <td>80 °C</td> <td>(-4 a 176 °F)</td> </tr> <tr> <td></td> <td>-40</td> <td>a</td> <td>85 °C</td> <td>(-40 a 185 °F) (Without damage)</td> </tr> </table>	Ambient:	-40	a	85 °C	(-40 a 185 °F)	Process:	-40	a	100 °C	(-40 a 212 °F) (Silicone oil)		-40	a	85 °C	(-40 a 185 °F) (Halocarbon and Inert oil)		0	a	85 °C	(32 a 185 °F) (Inert oil)		-20	a	85 °C	(-4 a 185 °F) (Inert Krytox Oil and Fomblim oil)		-25	a	100 °C	(-13 a 212 °F) (Viton O'ring)		-40	a	150 °C	(-40 a 302 °F) (Level Model)	Storage:	-40	a	100 °C	(-40 a 212 °F)	Display:	-20	a	80 °C	(-4 a 176 °F)		-40	a	85 °C	(-40 a 185 °F) (Without damage)
Ambient:	-40	a	85 °C	(-40 a 185 °F)																																															
Process:	-40	a	100 °C	(-40 a 212 °F) (Silicone oil)																																															
	-40	a	85 °C	(-40 a 185 °F) (Halocarbon and Inert oil)																																															
	0	a	85 °C	(32 a 185 °F) (Inert oil)																																															
	-20	a	85 °C	(-4 a 185 °F) (Inert Krytox Oil and Fomblim oil)																																															
	-25	a	100 °C	(-13 a 212 °F) (Viton O'ring)																																															
	-40	a	150 °C	(-40 a 302 °F) (Level Model)																																															
Storage:	-40	a	100 °C	(-40 a 212 °F)																																															
Display:	-20	a	80 °C	(-4 a 176 °F)																																															
	-40	a	85 °C	(-40 a 185 °F) (Without damage)																																															
<b>Turn-on Time</b>	Performs within specifications in less than 3 seconds after power is applied to the transmitter.																																																		
<b>Configuration</b>	<p>By digital communication (HART<sup>®</sup> protocol) using the configuration software CONF401, DDCON100 (for Windows), or HPC301 and HPC401 (for Palm). It can also be configured using DD and FDT/DTM tools, and can be partially configured through local adjustment.</p> <p>In order to keep the equipment configuration safe, the <b>LD301</b> has two kinds of write protection in its memory. One is via software and the other a hardware mechanism selected by a key with priority over the software.</p>																																																		
<b>Volumetric Displacement</b>	Less than 0.15 cm <sup>3</sup> (0.01 in <sup>3</sup> )																																																		
<b>Overpressure and Static Pressure Limits (MWP – Maximum Working Pressure)</b>	<p><b>From 3.45 kPa abs. (0.5 psia)* to:</b>                      5 bar (70 psi) for range 0                      80 bar (1200 psi) for range 1                      160 bar (2300 psi) for ranges 2, 3 &amp; 4                      320 bar (4600 psi) for models H2 to H4                      400 bar (5800 psi) for range 5                      520 bar (7500 psi) for range 6                      * <b>except the LD301A model</b>                      Flange Test Pressure: 68.95 MPa (1000 psi)</p> <table border="1" style="width: 100%; text-align: center;"> <thead> <tr> <th colspan="4">ANSI B 16.5 Pressure Class</th> </tr> <tr> <th>Class</th> <th>150</th> <th>300</th> <th>600</th> </tr> </thead> <tbody> <tr> <td><b>Temperature</b></td> <td colspan="3"><b>Pressure Limit</b></td> </tr> <tr> <td>-29 a 38 °C</td> <td>1893 kPa (274.6 psi)</td> <td>4962 kPa (719 psi)</td> <td>9924 kPa (1439.4 psi)</td> </tr> <tr> <td>93 °C</td> <td>1618 kPa (234.7 psi)</td> <td>4275 kPa (620 psi)</td> <td>8551 kPa (1240.2 psi)</td> </tr> <tr> <td>149 °C</td> <td>1481 kPa (214.8 psi)</td> <td>3864 kPa (560.4 psi)</td> <td>7717 kPa (1119.3 psi)</td> </tr> </tbody> </table>	ANSI B 16.5 Pressure Class				Class	150	300	600	<b>Temperature</b>	<b>Pressure Limit</b>			-29 a 38 °C	1893 kPa (274.6 psi)	4962 kPa (719 psi)	9924 kPa (1439.4 psi)	93 °C	1618 kPa (234.7 psi)	4275 kPa (620 psi)	8551 kPa (1240.2 psi)	149 °C	1481 kPa (214.8 psi)	3864 kPa (560.4 psi)	7717 kPa (1119.3 psi)																										
ANSI B 16.5 Pressure Class																																																			
Class	150	300	600																																																
<b>Temperature</b>	<b>Pressure Limit</b>																																																		
-29 a 38 °C	1893 kPa (274.6 psi)	4962 kPa (719 psi)	9924 kPa (1439.4 psi)																																																
93 °C	1618 kPa (234.7 psi)	4275 kPa (620 psi)	8551 kPa (1240.2 psi)																																																
149 °C	1481 kPa (214.8 psi)	3864 kPa (560.4 psi)	7717 kPa (1119.3 psi)																																																

Functional Specifications				
<b>DIN EN 1092-1 / DIN 2501</b>				
<b>Flange Material: 316L Stainless Steel</b>				
<b>Temperature</b>	<b>- 10 a 50 °C</b>	<b>50 °C</b>	<b>100 °C</b>	<b>150 °C</b>
<b>PN</b>	<b>Pressure Limit</b>			
<b>16</b>	1230 kPa (178.4 psi)	1180 kPa (171.1 psi)	1020 kPa (148 psi)	930 kPa (135 psi)
<b>40</b>	3060 kPa (443.8 psi)	2960 kPa (429.3 psi)	2550 kPa (370 psi)	2310 kPa (335 psi)
The overpressure above are not likely to damage the transmitter, although a new calibration may be needed.				
<b>Humidity Limits</b>	0 to 100% RH (Relative Humid).			
<b>Damping Adjustment</b>	User configurable from 0 to 128 seconds (via digital communication).			

Performance Specifications	
<b>Reference Conditions</b>	Span starting at zero, temperature of 25°C (77°F), atmospheric pressure, power supply of 24 Vcc, silicone oil fill fluid, isolating diaphragms in 316L SST and digital trim equal to lower and upper range values.
<b>Accuracy</b>	<p><b>For range 0, and differential or gage models and 316L SST or hastelloy diaphragm with silicon or halocarbon filling fluid:</b></p> <p><b>0.2 URL ≤ span ≤ URL:</b> ± 0.1% of span  <b>0.05 URL ≤ span &lt; 0.2 URL:</b> ± [0.025+0.015 URL/span]% of span</p> <p><b>For ranges 1, 2, 3, 4, 5 or 6, differential or gage models, and 316L SST or hastelloy diaphragm with silicon or halocarbon filling fluid:</b></p> <p><b>0.1 URL ≤ span ≤ URL:</b> ± 0.075% of span  <b>0.025 URL ≤ span &lt; 0.1 URL:</b> ± [0.0375+0.00375.URL/span]% of span  <b>0.0083 URL ≤ span &lt; 0.025 URL:</b> ± [0.0015+0.00465.URL/span]% of span</p> <p><b>For ranges 2 to 6 and absolute model. For tantalum or monel diaphragm. For fluorolube filling fluid:</b></p> <p><b>0.1 URL ≤ span ≤ URL:</b> ± 0.1% of span  <b>0.025 URL ≤ span &lt; 0.1 URL:</b> ± 0.05[1+0.1 URL/span]% of span  <b>0.0083 URL ≤ span &lt; 0.025 URL:</b> ± [0.01+0.006 URL/span]% of span</p> <p><b>For range 1 and absolute model:</b>                      ± 0.2% of span</p> <p><b>For ranges 2, 3 or 4 and level model and 316L SST diaphragm with silicon or halocarbon filling fluid with maximum pressure matching the flange pressure class:</b></p> <p><b>0.1 URL ≤ span ≤ URL:</b> ± 0.075% of span  <b>0.025 URL ≤ span &lt; 0.1 URL:</b> ± [0.0375+0.00375.URL/span]% of span  <b>0.0083 URL ≤ span &lt; 0.025 URL:</b> ± [0.0015+0.00465.URL/span]% of span</p> <p>Linearity effects, hysteresis and repeatability are included.</p>
<b>Stability</b>	<p><b>For ranges 2, 3, 4, 5 and 6:</b> ± 0.15% of URL for 5 years at 20 °C temperature change and up to 7 MPa (1000 psi) of static pressure.</p> <p><b>For ranges 0 and 1:</b> ± 0.2% of URL for 12 months at 20 °C temperature change and up to 100 kPa (1bar) of static pressure.</p> <p><b>For Level model:</b> ± 0.2% of URL for 12 months at 20 °C temperature change.</p>
<b>Temperature Effect</b>	<p><b>For ranges 2, 3, 4 and 5:</b></p> <p><b>0.2 URL ≤ span ≤ URL:</b> ± [0.02% URL + 0.06% span] per 20 °C (68 °F)  <b>0.0085 URL ≤ span &lt; 0.2 URL:</b> ± [0.023% URL + 0.045% span] per 20 °C (68°F)</p> <p><b>For range 1:</b></p> <p><b>0.2 URL ≤ span ≤ URL:</b> ± [0.08% URL + 0.05% span] per 20 °C (68 °F)  <b>0.025 URL ≤ span &lt; 0.2 URL:</b> ± [0.06% URL + 0.15% span] per 20 °C (68 °F)</p> <p><b>For range 0:</b></p> <p><b>0.2 URL ≤ span ≤ URL:</b> ± [0.15% URL + 0.05% span] per 20 °C (68 °F)  <b>0.05 URL ≤ span &lt; 0.2 URL:</b> ± [0.1% URL + 0.3% span] per 20 °C (68 °F)</p> <p><b>For level model:</b></p>

Performance Specifications	
	6 mmH <sub>2</sub> O per 20 °C for 4" and DN100 17 mmH <sub>2</sub> O per 20 °C for 3" and DN80 Consult Smar for other flange dimensions and fill fluid.
<b>Static Pressure Effect</b>	<p><b>Zero error:</b>  <b>For ranges 2, 3, 4 and 5:</b> ± 0.033% of URL per 7MPa (1000 psi)  <b>For range 1:</b> ± 0.05% of URL per 1.7 MPa (250 psi)  <b>For range 0:</b> ± 0.1% of URL per 0.5 MPa (5 bar)  <b>For Level model:</b> ± 0.1% of URL per 3.5 MPa (500 psi)</p> <p>The zero error is a systematic error that can be eliminated by calibrating at the operating static pressure.</p> <p><b>Span error:</b>  <b>For ranges 2, 3, 4, 5 and 6:</b> correctable to ± 0.2% of reading per 7MPa (1000 psi)  <b>For range 1 and level transmitters:</b> correctable to ± 0.2% of reading per 3.5 MPa (500 psi)  <b>For range 0:</b> correctable to ± 0.2% of reading per 0.5 MPa (5 bar) (70 psi)</p>
<b>Power Supply Effect</b>	± 0.005% of calibrated span per volt
<b>Mounting Position Effect</b>	Zero shift of up to 250 Pa (1 inH <sub>2</sub> O) which can be calibrated out. No span effect.
<b>Electromagnetic Interference Effect</b>	Approved according to IEC61326-1:2006, IEC61326-2-3:2006, IEC61000-6-4:2006, IEC61000-6-2:2005.

Physical Specifications	
<b>Electrical Connection</b>	<p>1/2 - 14 NPT            3/4 - 14 NPT with 316 SST adapter for 1/2 - 14 NPT)            3/4 - 14 BSP with 316 SST adapter for 1/2 - 14 NPT)            1/2 - 14 BSP with 316 SST adapter for 1/2 - 14 NPT)            M20 X 1.5            PG 13.5 DIN</p> <p><b>Note:</b> Explosion Proof approvals do not apply to adapter, only to transmitter.</p>
<b>Process Connection</b>	1/4 - 18 NPT or 1/2 -14 NPT (with adapter) For level models or other options, see the Ordering Code.
<b>Wetted Parts</b>	<p><b>Isolating Diaphragms:</b>            316L SST, Hastelloy C276, Monel 400 or Tantalum</p> <p><b>Drain/Vent Valves and Plug:</b>            316 SST, Hastelloy C276 or Monel 400</p> <p><b>Flanges:</b>            Plated Carbon Steel, 316 SST-CF8M (ASTM - A351), Hastelloy C276 - CW-12MW, (ASTM - A494) or Monel 400</p> <p><b>Wetted O-Rings (For Flanges and Adapters):</b>            Buna N, Viton™ PTFE or Ethylene-Propylene.            The <b>LD301</b> is available in NACE MR-01-75/ISO 15156 compliant materials.</p>
<b>Nonwetted Parts</b>	<p><b>Electronic Housing:</b>            Injected aluminum with polyester painting, epoxy painting or 316 SST - CF8M (ASTM - A351) housing. Complies with NEMA 4X/6P, IP66 or IP66W*, IP68 or IP68W*.  <i>*The IP66/68W sealing test (immersion) was performed at 1 bar for 24 hours. For any other situation, please consult Smar. IP66/68W tested for 200h to according NBR 8094 / ASTM B 117 standard.</i></p> <p><b>Blank Flange:</b>            When flange adapter and Drain/Vent material is carbon steel, blank flange is in carbon steel, otherwise blank flange is in 316 SST - CF8M (ASTM - A351)</p> <p><b>Level Flange (LD301L):</b>            316 L SST, 304 SST, Hastelloy C276 and Plated Carbon Steel.</p> <p><b>Fill Fluid:</b>            Silicone, Inert , Krytox, Halocarbon 4.2 or Fomblim oils</p> <p><b>Cover O-Rings:</b>            Buna N</p> <p><b>Mounting Bracket:</b>            Plated carbon steel or 316 SST            Accessories (bolts, nuts, washers and U-clamps) in carbon steel or 316 SST</p>



Physical Specifications	
	<p><b>Flange Bolts and Nuts:</b> Plated carbon steel, Grade 8 or 316 SST For NACE applications: carbon steel ASTM A193 B7M</p> <p><b>Identification Plate:</b> 316 SST</p>
<b>Mounting</b>	<p>a) Flange mounted for Level models. b) Optional universal mounting bracket for surface or vertical/horizontal 2"- pipe (DN 50). c) Manifold Valve integrated to the transmitter. d) Directly on piping for closely coupled transmitter/orifice flange combinations.</p>
<b>Approximate Weights</b>	<p>3.15 kg (7 lb): all models, except L models. 5.85 to 9.0 kg (13 lb to 20 lb): L models depending on the flanges, extension and materials.</p>
<b>Control Functions Characteristics (Optional)</b>	Control Block (PID) and Totalizer (TOT)

**Technical Characteristics of High Performance - CODE L1**

High Performance option (code L1) is available under the following conditions only:

Application	Differential and Gage
<b>Range</b>	D2 -50 to 50 kPa -200 to 200 inH <sub>2</sub> O
	D3 -250 to 250 kPa -36 to 36 psi
	D4 -2500 to 2500 kPa -360 to 360 psi
	M2 -50 to 50 kPa -200 to 200 inH <sub>2</sub> O
	M3 -100 to 250 kPa -14.5 to 36 psi
	M4 -100 to 500 kPa -14.5 to 360 psi
<b>Diaphragm Material</b>	316L SST or Hastelloy C276
<b>Fill Fluid</b>	Silicone

Performance Specifications	
<b>Reference Conditions</b>	Span starting at zero, temperature of 25 °C (77 °F), atmospheric pressure, power supply of 24 Vdc, silicone oil fill fluid, isolating diaphragms in 316L SST and digital trim equal to lower and upper range values.
<b>Accuracy</b>	<p><b>For range 2:</b>  <b>0.2 URL ≤ span ≤ URL:</b> ± 0.04% of span  <b>0.05 URL ≤ span &lt; 0.2 URL:</b> ± [0.021667+0.003667URL/span]% of span  <b>0.0085 URL ≤ span &lt; 0.05 URL:</b> ± [0.0021+0.004645URL/span]% of span</p> <p><b>For ranges 3 or 4:</b>  <b>0.1 URL ≤ span ≤ URL:</b> ± 0.05% of span  <b>0.05 URL ≤ span &lt; 0.1 URL:</b> ± [0.005+0.0045URL/span]% of span  <b>0.0085 URL ≤ span &lt; 0.05 URL:</b> ± [0.0021+0.004645URL/span]% of span</p>
<b>Stability</b>	<p><b>For range 2:</b> ± 0.05% of URL for 6 months  <b>For range 3:</b> ± 0.075% of URL for 12 months  <b>For range 4:</b> ± 0.1% of URL for 24 months                      ± 0.2% of URL for 12 years, at 20 °C temperature change and up to 7 MPa (1000 psi) {70 bar} of static pressure, environment free of hydrogen migration.</p>
<b>Temperature Effect</b>	<p><b>From -10 °C to 50 °C, protected from direct sun radiation:</b>  <b>0.2 URL ≤ span ≤ URL:</b> ±[0.018% URL + 0.012% span] per 20 °C (68 °F)  <b>0.0085 URL ≤ span &lt; 0.2 URL:</b> ±[0.02% URL + 0.002% span] per 20 °C (68 °F)</p>
<b>Static Pressure Effect</b>	<p><b>Zero error:</b>                      ± 0.025% URL per 7 MPa (1000 psi)                      The zero error is a systematic error that can be eliminated by calibrating at the operating static pressure.</p> <p><b>Span error:</b>                      Correctable to ± 0.2% of reading per 7 MPa (1000 psi).</p>

NOTES		
Hastelloy is a trademark of the Cabot Corp.	Inert is a trademark of Hooker Chemical Corp.	Smar Pressure Transmitters are protected by US patent number 6,433,791
Monel is a trademark of International Nickel Co.	Halocarbon is a trademark of Halocarbon.	
Viton and Teflon are trademarks of E. I. DuPont de Nemours & Co.	HART® is a trademark of HART® communication Foundation.	

# Ordering Code

MODEL DIFFERENTIAL , FLOW, GAGE, ABSOLUTE AND HIGH STATIC PRESSURE TRANSMITTER									
COD.	Type	Range Limits		Min. Span	Unit	Range Limits		Min. Span	Unit
		Min.	Max.			Min.	Max.		
D0	Differential and Flow	-1	1	0.05	kPa	-4	4	0,05	inH <sub>2</sub> O
D1	Differential and Flow	-5	5	0.13	kPa	-20	20	0,13	inH <sub>2</sub> O
D2	Differential and Flow	-50	50	0.42	kPa	-200	200	0,42	inH <sub>2</sub> O
D3	Differential and Flow	-250	250	2.08	kPa	-14,7	36	2,08	psi
D4	Differential and Flow	-2500	2500	20.83	kPa	-14,7	360	20,83	psi
M0	Gage	-1	1	0.05	kPa	-4	4	0,05	inH <sub>2</sub> O
M1	Gage	-5	5	0.13	kPa	-20	20	0,13	inH <sub>2</sub> O
M2	Gage	-50	50	0.42	kPa	-200	200	0,42	inH <sub>2</sub> O
M3	Gage	-100	250	2.08	kPa	-14,7	36	2,08	psi
M4	Gage	-100	2500	20.83	kPa	-14,7	360	20,83	psi
M5	Gage	-0.1	25	0.21	MPa	-14,7	3600	0,21	psi
M6	Gage	-0.1	40	0.33	MPa	-14,7	5800	0,33	psi
A1	Absolute	0	5	2.00	kPa	0	20	2,00	inH <sub>2</sub> O
A2	Absolute	0	50	2.50	kPa	0	200	2,50	inH <sub>2</sub> O
A3	Absolute	0	250	5.00	kPa	0	36	5,00	psi
A4	Absolute	0	2500	20.83	kPa	0	360	20,83	psi
A5	Absolute	0	25	0.21	Mpa	0	3600	0,21	psi
A6	Absolute	0	40	0.33	MPa	0	5800	0,33	psi
H2	Differential – High Static Pressure	-50	50	0.42	kPa	-200	200	0,42	inH <sub>2</sub> O
H3	Differential – High Static Pressure	-250	250	2.08	kPa	-14,7	36	2,08	psi
H4	Differential – High Static Pressure	-2500	2500	20.83	kPa	-14,7	360	20,83	psi
H5	Differential – High Static Pressure	-25	25	0.21	MPa	-14,7	3600	0,21	psi

**NOTE:** The range can be extended up to 0.75 LRL\* and 1.2 URL\*\* with small degradation of accuracy.  
\*LRL = Lower Range Limit.  
\*\*URL = Upper Range Limit.

COD. Diaphragm Material and Fill Fluid									
1	316 SST	Silicone Oil (9)	8	Tantalum	Inert Oil Fluorolube (2) (3) (15)	K	Monel 400	Inert Oil Krytox (1) (3) (15)	
2	316 SST	Inert Oil Fluorolube (2) (15)	9	316L SST	Fomblim Oil	M	Monel 400 Gold Plated	Silicone Oil (1) (3) (9)	
3	Hastelloy C276	Silicone Oil (1) (9)	A	Monel 400	Fomblim Oil (1) (3)	P	Monel 400 Gold Plated	Inert Oil Krytox (1) (3) (15)	
4	Hastelloy C276	Inert Oil Fluorolube (1) (2) (15)	D	316L SST	Inert Oil Krytox (3) (15)	Q	316 SST	Inert Oil Halocarbon 4.2 (2) (3) (15)	
5	Monel 400	Silicone Oil (1) (3) (9)	E	Hastelloy C276	Inert Oil Krytox (1) (3) (15)	R	Hastelloy C276	Inert Oil Halocarbon 4.2 (2) (3) (15)	
7	Tantalum	Silicone Oil (3) (9)	G	Tantalum	Inert Oil Krytox (3) (15)	S	Tantalum	Inert Oil Halocarbon 4.2 (2) (3) (15)	

COD. Flange(s), Adapter(s) and Drain/Vent Valves Material									
C	Plated CS (Drain/Vent in Stainless Steel) (16)					M	Monel 400 (1)		
H	Hastelloy C276 (CW-12MW, ASTM-A494) (1)					N	316 SST – CF8M (ASTM A351) (Drain/Vent in Hastelloy C276) (1)		
I	316 SST – CF8M (ASTM A351)					P	316 SST – CF8M (ASTM A351) Flange with PVDF (Kynar) Insert (4) (5) (7) (11)		

COD. Wetted O-Rings Materials									
0	Without O'Rings					K	Kalrez (3)		
B	Buna N					T	Teflon		
E	Ethylene – Propylene (12)					V	Viton		

**Note:** O-Rings are not available on the sides with remote Seals.

COD. Drain/Vent Position									
O	Without Drain/Vent					D	Bottom		
A	Drain/Vent (Opposite to Process Connection)					U	Top		

**Note:** For better drain/vent operation, vent valves are strongly recommended. Drain/Vent valve are not available on the sides with remote seals

COD. Local Indicator									
0	Without Indicator					1	With Digital Indicator		

COD. Process Connections									
0	1/4 - 18 NPT (Without Adapter)					B	High Side : 1/2 - 14 NPT and Low Side : Remote Seal (With Plug) (10) (12)		
1	1/2 - 14 NPT With Adapter					D	High Side : Remote Seal (With Plug) and Low Side – 1/2 - 14 NPT (10) (12)		
3	Remote Seal (With Plug) (3) (8)					F	High Side : 1/2 - 14 NPT and Low Side - Remote Seal (Low Volume Flange) (10) (12)		
5	1/2 - 14 NPT Axial with PVDF Insert (5) (7) (14)					H	High Side : Remote Seal (Low Volume Flange) and Low Side -1/2 – 14 NPT (10) (12)		
9	Remote Seal (Low Volume Flange) (3) (4) (8)					Q	8mm hole without thread. According to DIN 19213 (13)		
T	1/2 - 14 BSP (With Adapter)					Z	User's specification		
V	Manifold Valve Integrated to the Transmitter								

COD. Electrical Connections									
0	1/2 - 14 NPT (17)					A	M20 X 1.5 (19)		
1	3/4 - 14 NPT with 316 SST adapter for 1/2 - 14 NPT (18)					B	PG 13.5 DIN (19)		
2	3/4 - 14 BSP with 316 SST adapter for 1/2 - 14 NPT (6)					Z	User's specification		
3	1/2 - 14 BSP with 316 SST adapter for 1/2 - 14 NPT (6)								

COD. Zero Span Adjustment									
1	With Zero and Span Adjustment								

COD. Mounting Bracket for 2" Pipe or Surface Mounting									
0	Without Bracket					7	Carbon steel bracket. Accessories: 316 SST (16)		
1	Carbon steel bracket and accessories (16)					9	L Type, carbon steel bracket. Accessories: 316 SST (16)		
2	316 SST bracket and accessories					A	Flat, 304 SST bracket and 316 SST accessories		
5	L type, carbon steel bracket and accessories (16)					Z	User's specification		
6	L type, 316 SST bracket and accessories								

COD. Continues next page									

LD301 D2 1 I B U 1 0 0 1 2 \*

← TYPICAL MODEL NUMBER

Notes	
(1) Meets NACE MR – 01 – 75/ISO 15156 recommendations.	(11) O’Ring should be Viton or Kalrez.
(2) Not available for absolute models nor vacuum applications.	(12) Not available for range 0.
(3) Not available for range 0 and 1.	(13) Only available for pressure transmitters D4 or H4 and 7/16 UNF or M10 x 1.5 flange thread for fixing accessories.
(4) Not recommended for vacuum service.	(14) Only available for flange with PVDF (Kynar) insert.
(5) Maximum pressure 24 bar (350 psi).	(15) Inert Fluid: Safe for oxygen service.
(6) Options not certified for hazardous locations.	(16) Not applicable for saline atmosphere.
(7) Drain/Vent not applicable.	(17) Certificate for use in Hazardous Locations (CEPEL, NEPSI, NEMKO, EXAM, FM, CSA).
(8) For remote seal only 316 SST – CF8M (ASTM A351) flange is available (thread 7/16 UNF).	(18) Certificate for use in Hazardous Locations (CEPEL, CSA).
(9) Silicone Oil is not recommended for oxygen (O2) or Chlorine service.	(19) Certificate for use in Hazardous Locations (CEPEL, NEPSI, NEMKO, EXAM).
(10) Only available for differential pressure transmitters.	

LD301		DIFFERENTIAL, FLOW, GAGE, ABSOLUTE AND HING STATIC PRESSURE TRANSMITTER (CONTINUATION)	
COD.		Flanges Bolts and Nuts Material	
A0	Plated Carbon Steel (Default) (6)	A5	Hastelloy C276
A1	316 SST		
A2	Carbon Steel (ASTM A193 B7M) (1) (6)		
COD.		Flange thread for fixing accessories (adapters, manifolds, mounting brackets, etc)	
D0	7/16" UNF (Default)	D2	M12 X 1.75
D1	M10 X 1.5		
COD.		Output Signal	
G0	4 – 20 mA (Default)		
G1	0 – 20 mA (4 wires) (2)		
G3	NAMUR NE extended 4-20 mA (Burnout 3,55 to 22,8 mA)		
COD.		Housing Material (8) (9)	
H0	Aluminum (Default) (IP/TYPE)	H3	316 SST for saline atmosphere (IPW/TYPEX) (7)
H1	316 SST – CF8M (ASTM – A351) IP/TYPE	H4	Copperfree Aluminium (IPW/TYPEX) (7)
H2	Aluminium for saline atmosphere (IPW/TYPEX) (7)		
COD.		Tag Plate	
J0	With tag, when specified (Default)		
J1	Blank		
J2	According to user's notes		
COD.		PID Configuration	
M0	With PID (Default)		
M1	Without PID		
COD.		LCD1 Indication	
Y0	LCD1: Percentage (Default)	Y3	LCD1: Temperature (Engineering Unit)
Y1	LCD1: Current – I (mA)	YU	LCD1: According to user notes (4)
Y2	LCD1: Pressure (Engineering Unit)		
COD.		LCD2 Indication	
Y0	LCD2: Percentage (Default)	Y6	LCD2: Temperature (Engineering Unit)
Y4	LCD2: Current – I (mA)	YU	LCD2: According to user notes (4)
Y5	LCD2: Pressure (Engineering Unit)		
COD.		Identification Plate	
I1	FM: XP, IS, NI, DI	I7	EXAM (DMT): Group I, M1 Ex-ia
I2	NEMKO: Ex-d, Ex-ia	I8	0 a 20 mA (2)
I3	CSA: XP, IS, NI, DI	IF	CEPEL: Ex-d
I4	EXAM (DMT): Ex-ia	IE	NEPSI: Ex-ia (5)
I5	CEPEL: Ex-d, Ex-ia	IH	CEPEL + IP68
I6	Without Certification		
COD.		Painting	
P0	Gray Munsell N 6.5 Polyester	P8	Without Painting
P3	Black Polyester	P9	Blue Safety Epoxy – Electrostatic Painting
P4	White Epoxy	PC	Blue Safety Polyesters – Electrostatic Painting
P5	Yellow Polyester		

LD301 - D211 - BU10 - 012	A0	D0	G0	H0	J0	M0	Y0	Y4	I6	P0
---------------------------	----	----	----	----	----	----	----	----	----	----

← TYPICAL MODEL NUMBER

### Optional Items

Leave blank for no optional items

Burn-out	BD – Down Scale (Accordance to NAMUR NE43 specification). BU – Up Scale (Accordance to NAMUR NE43 specification).
Special Applications	C1 – Degrease Cleaning (Oxygen or Chlorine Service) (5).
High Performance	L1 – 0.04% accuracy (3).
Square Root Extraction	M3 – With Square Root extraction.
Special Features	ZZ – User's specification.

**LD301 – Operation and Maintenance Instruction Manual**

**Notes**

- (1) Meets NACE MR – 01 – 75/ISO 15156 recommendations.
- (2) Without explosion proof or intrinsic safety approvals.
- (3) Only available for differential and gage pressure models.
- (4) Values limited to 4 1/2 digits, unit limited to 5 characters.
- (5) Degrease cleaning not available for carbon steel flanges.
- (6) Not applicable for saline atmosphere.
- (7) IP66/68W tested for 200 hours according to NBR 8094 / ASTM B 117 standard.
- (8) IPX8 tested in 10 meters of water column for 24 hours.
- (9) Ingress Protection:

Product	CEPEL	NEMKO/EXAM	FM	CSA	NEPSI
LD300	IP66/68W	IP66/68W	Type4X/6(6P)	Type4X	IP67

MODEL	FLANGED PRESSURE TRANSMITTER											
COD.	Range Limits		Min. Span	Unit	Range limits		Min. Span	Unit	<b>Note:</b> The range can be extended up to 0.75 LRL and 1.2 URL with small degradation of accuracy. The upper range value must be limited to the flange rating.			
	Min.	Max.		Min.	Max.							
	L2	-50	50	1.25	kPa	-200	200	0.42				inH <sub>2</sub> O
	L3	-250	250	2.08	kPa	-14.7	36	2.08				psi
	L4	-2500	2500	20.83	kPa	-14.7	360	20.83				psi
L5	-25000	25000	208.3	kPa	-14.7	3600	0.21	psi				
COD.	Diaphragm material and Fill Fluid (Low Side)											
1	316L SST	Silicone Oil (2)		7	Tantalum	Silicone Oil (2)		E	Hastelloy C276	Inert Oil Krytox (1)(21)		
2	316L SST	Inert Oil Fluorolube(3)(21)		8	Tantalum	Inert Oil Fluorolube (3) (21)		G	Tantalum	Inert Oil Krytox (21)		
3	Hastelloy C276	Silicone Oil (1) (2)		9	316L SST	Fomblim Oil		K	Monel 400	Inert Oil Krytox (1) (21)		
4	Hastelloy C276	Inert Oil Fluorolube (1)(3)(21)		A	Monel 400	Fomblim Oil (1)		M	Monel 400 Gold Plated	Silicone Oil (1) (2)		
5	Monel 400	Silicone Oil (1) (2)		D	316L SST	Inert Oil Krytox (21)		P	Monel 400 Gold Plated	Inert Oil Krytox (1) (21)		
COD.	Flange, Adapter and Drain/Vent Valves material (Low Side)											
A	304L SST											
C	Plated CS (Drain/Vent in Stainless Steel) (22)											
H	Hastelloy C276 (CW – 12MW, ASTM – A494) (1)											
I	316 SST – CF8M (ASTM – A351)											
M	Monel 400 (1)											
N	316 SST – CF8M (ASTM – A351) (Drain/Vent in Hastelloy C276) (1)											
P	316 SST – CF8M (ASTM – A351) Flange with PVDF (Kynar) insert (3) (4) (5)											
COD.	Wetted O'Ring Material (Low Side)											
0	Without O'Rings											
B	Buna-N											
E	Ethylene - Propylene											
K	Kalrez											
T	Teflon											
V	Viton											
<b>Note:</b> O'rings are not available on the sides with remote seals.												
COD.	Drain/Vent Position (Low Side)											
0	Without Drain/Vent											
A	Drain/Vent (Opposite to Process Connection)					D	Bottom					
U	Top											
<b>Note:</b> For better Drain/Vent operation, vent valves are strongly recommended. Drain/Vent valve are not available on the sides with remote seals.												
COD.	Local Indicator											
0	Without Indicator											
1	With Digital indicator											
COD.	Process Connection (Low Side)											
0	1/4 - 18 NPT (Without Adapter)											
1	1/2 - 14 NPT (With Adapter)											
3	Remote Seal (With Plug ) (7)											
5	1/2 - 14 NPT Axial with PVDF Insert (3) (4) (6)											
9	Remote Seal (Low Volume Flange) (3) (7)											
T	1/2 14 BSP (With Adapter)											
U	Low Volume Flange For Level Welded											
V	Without Connection (Mounting With Gage Flange)											
W	Without Connection (Absolut Reference)											
COD.	Electrical Connection											
0	1/2 – 14 NPT (27)											
1	3/4 – 14 NPT (with 316 SST adapter for 1/2 - 14 NPT) (24)											
2	3/4 – 14 BSP (with 316 SST adapter for 1/2 - 14 NPT) (9)											
3	1/2 – 14BSP (with 316 SST adapter for 1/2 - 14 NPT) (9)											
A	M20 x 1.5 (28)											
B	PG 13.5 DIN (28)											
Z	User's specification											
COD.	Zero and Span Adjust											
1	With Zero and Span Adjustment											
COD.	Process Connection											
U	1" 150 # (ANSI B16.5) (31)			C	3" 600 # (ANSI B16.5)			S	JIS 40A 20K (25)			
V	1" 300 # (ANSI B16.5) (31)			N	3" 600 # (ANSI B16.5 RTJ)			F	JIS 50A 10K (25)			
W	1" 600 # (ANSI B16.5) (31)			3	4" 150 # (ANSI B16.5)			T	JIS 50A 40K (25)			
O	1.1/2" 150 # (ANSI B16.5)			4	4" 300 # (ANSI B16.5)			K	JIS 50A 20K (25)			
P	1.1/2" 300 # (ANSI B16.5)			D	4" 600 # (ANSI B16.5)			G	JIS 80A 10K (25)			
Q	1.1/2" 600 # (ANSI B16.5)			5	DN25 PN 10/40 (31)			L	JIS 80A 20K (25)			
9	2" 150 # (ANSI B16.5)			R	DN 40 PN 10/40			H	JIS 100A 10K (25)			
A	2" 300 # (ANSI B16.5)			E	DN 50 PN 10/40			M	JIS 100A 10K (25)			
B	2" 600 # (ANSI B16.5)			6	DN 80 PN 10/40			Z	User's specification			
1	3" 150 # (ANSI B16.5)			7	DN 100 PN 10/16							
2	3" 300 # (ANSI B16.5)			8	DN 100 PN 25/40							
COD.	Type and Flange Material ( Level Tap)											
2	316L SST (Integral Flange)			4	304 SST (Slip-on Flange)			6	Carbon Steel (Slip-on Flange)			
3	Hastelloy C276 (Integral Flange)			5	316 SST (Slip-on Flange)			Z	User's specification			
COD.	Extension Length											
0	0 mm (0")		2	100 mm (4")		4	200 mm (8")					
1	50 mm (2")		3	150 mm (6")		Z	User's specification			<b>Note:</b> Extension Material 316L SST		
COD.	Diaphragm Material / Extension (Level Tap)											
A	304L SST / 304L SST					6	316L SST with Teflon Lining (For 2" and 3")					
1	316L SST / 316 SST					7	316L SST Gold plated					
2	Hastelloy C276 / 316 SST					B	Tantalum with Teflon Lining					
3	Monel 400 / 316 SST					L	316L SST Halar Plated (20)					
4	Tantalum / 316 SST (10)					C	Hastelloy Teflon Plated					
5	Titanium / 316 SST (10)											
COD.	Fill Fluid											
1	DC – 200/20 Silicone Oil			4	Krytox Oil			B	Fomblim 06/06			
3	DC704 Silicone Oil			N	Neobee M20 Propylene Glycol Oil			H	Halocarbon 4.2			
2	MO – 10 Fluorolube Oil (8)			G	Glycerin (6)			T	Syltherm 800 Oil			
COD.	Housing Material											
0	Without Gaskets (12)											
1	316 SST											
2	Hastelloy C276											
3	Super Duplex (UNS 32750) (11)											
4	Duplex (UNS 31803) (11)											
5	Stainless Steel 304L (11)											
COD.	Gasket Material											
0	Without gasket											
T	Teflon (PTFE)					G	Grafoil (Flexible lead)			I	316 L SST	
C	Copper											
COD.	Continues Next Page											

LD301 L2 1 I B U 1 0 0 1 1 1 2 2 1 1 1 T \*

← TYPICAL MODEL NUMBER

LD301	FLANGED PRESSURE TRANSMITTER (CONTINUATION)										
COD. Flanges Bolts and Nuts Material											
A0	Plated Carbon Steel (Default) (22)				A2	Carbon Steel (ASTM A193 B7M) (1) (22)					
A1	316 SST				A5	Hastelloy C276					
COD. Flange Thread for Fixing Accessories (Adapters, Manifolds, Mounting Brackets, etc)											
D0	7/16" UNF (Default)				D1	M10 X 1.5 Thread			D2	M12 X 1.75	
COD. Flange Facing Finish											
Q0	Raised Face – RF (Default)			Q2	Ring Joint Face – RTJ (Only available for ANSI standard flange) (17)				Q4	Grooved Face (11)	
Q1	Flat Face – FF			Q3	Tongue Face (11)						
COD. Output Signal											
G0	4 – 20 mA (Default)			G1	0 – 20 mA (4 wire) (13)			G3	NAMUR NE extended 4-20 mA (Burnout 3,55 to 22,8 mA)		
COD. Housing Material (29) (30)											
H0	Aluminum (Default)		H1	316 SST – CF8M ASTM – A351			H2	Aluminium (23)		H3	316 SST (23)
H4	Copperfree Aluminium (23)										
COD. Tag Plate											
J0	With tag, when specified (Default)			J1	Blank			J2	According to user's notes		
COD. PID Configuration											
M0	With PID (Default)				M1	Without PID					
COD. LCD1 Indication											
Y0	LCD1: Percentage (Default)			Y2	LCD1: Pressure (Engineering Unit)			YU	LCD1: According to user notes (3)		
Y1	LCD1: Current – I (mA)			Y3	LCD1: Temperature (Engineering Unit)						
COD. LCD2 Indication											
Y0	LCD2: Percentage (Default)			Y5	LCD2: Pressure (Engineering Unit)			YU	LCD2: According to user notes (3)		
Y4	LCD2: Current – I (mA)			Y6	LCD2: Temperature (Engineering Unit)						
COD. Identification Plate											
I1	FM: XP, IS, NI, DI			I5	CEPEL: Ex-d, Ex-ia			I8	0 to 20 mA: LD301 (13)		
I2	NEMKO: Ex-d, Ex-ia			I6	Without Certification			IF	CEPEL: Ex-d		
I3	CSA: XP, IS, NI, DI			I7	EXAM (DMT): Group I, M1 Ex-ia			IM	BDSR-GOST: Ex-d, Ex-ia		
I4	EXAM (DMT): Ex-ia										
COD. Painting											
P0	Gray Munsell N6,5 Polyesters			P8	Without Painting						
P3	Black Polyester			P9	Blue Safety Epoxy – Electrostatic Painting						
P4	White Epoxy			PC	Blue Safety Polyesters – Electrostatic Painting						
P5	Yellow Polyester										

LD301-L2I-BU10-01-12211	A0	D0	F0	G0	H0	J0	M0	Y0	Y0	I6	P0
-------------------------	----	----	----	----	----	----	----	----	----	----	----

← TYPICAL MODEL NUMBER

### Optional Items

\* Leave blank for no optional items

Burn-out	BD - Down Scale (Accordance to NAMUR NE43 specification)	BU - Up Scale (Accordance to NAMUR NE43 specification).
Special Applications	C1 - Degrease Cleaning (Oxygen or Chlorine Service (4))	C2 - For vacuum application.
Special Features	ZZ - User's specification.	
Gasket Connection	U0 - With one Flush Connection ¼" NPT (if supplied with gasket) U1 - With two Flush Connections ¼" NPT per 180 °C U2 - With two Flush Connections ¼" NPT per 90 °C U3 - With two Flush Connections ½" NPT - 14 NPT per 180 °C (with cover) U4 - Without Gasket Connection	
Isolator Kit (16)	K0 - Without Kit	K1 - With Kit
Diaphragm Thickness	N0 – Default (26)	N1 - 0.1mm (11)

**NOTES**

- ( 1 ) Meets NACE MR – 01 – 75/ISO 15156 recommendations.
- ( 2 ) Silicone Oils not recommendations for Oxygen (O<sub>2</sub>) or Chlorine service.
- ( 3 ) Not applicable for vacuum service.
- ( 4 ) Drain/Vent not applicable.
- ( 5 ) O'Ring should be Viton or Kalrez.
- ( 6 ) Maximum pressure 24 bar.
- ( 7 ) For remote Seal only 316 SST - CF8M (ASTM A3510 flange is available (thread M12).
- ( 8 ) Fluorolube fill fluid is not available for Monel diaphragm.
- ( 9 ) Options not certified for hazardous locations.
- (10) Attention, check corrosion rate for the process, tantalum plate 0.1 mm, AISI 316L extension 3 to 6mm.
- (11) Item by inquiry.
- (12) Supplied without Gasket.
- (13) Without certification for Explosion proof certification or Intrinsically safe.
- (14) Limited values to 4 1/2 digits; limited unit to 5 characters.
- (15) Degreaser's cleaning is not available for carbon steel flanges
- (16) The insulator kit is applicable with Raised Face (HO) and Smooth Face (H1) with Gasket material.  
T(Teflon) and only for the following models:  
- For models with extension the Gasket T (Teflon) it has special share.
- (17) Gasket for housing, available only in Stainless 316.
- (18) Finishing flange faces:  
ANSI B 16.5 / MSS-SP6:  
- Raised or Smoth Face with grooved lining: 3.2 to 6.3 µm Ra (125 a 250 µ" AA);  
Small or Large Tongue Face and Small or Large Groove with smooth finishing  
not exceeding: 3.2 µm Rt (125 µ" AA);  
RTJ ANSI B 16.20 / MSS-SP6:  
- Smooth finishing not exceeding: 1.6 µm Rt (63 µ" AA);  
DIN EN-1092-1:  
- Grooved finishing "B1" (PN 10 a PN40): 3.2 a 12.5 µm Ra (125 a 500 µ" AA);  
Smooth finishing "B2" (PN 63 a PN100), "C" (Tongue) e "D" (Groove): 0.8 a 3.2 µm Ra (32 a 125 µ" AA).

- DIN 2501 (DIN 2526):  
- Smooth finishing "E" (PN 160 a PN250): Rz = 16 (3.2 µm Ra (125 µ" AA).  
Standard JIS B2201  
Grooved finishing 3.2 a 6.3 µm Ra (125 a 250 µ" AA).
- (19) Range of application of temperature from -40 °C to 150 °C.
- (20) Applicable only to:  
- Thickness of steel: 0.05 mm  
- Diameter/capillary length:  
2" ANSI B 16.5 DN 50 DIN, JIS 50 A, for seals up to 3 meters of capillary and level models (by inquiry).  
3" ANSI B 16.5 DN 80 DIN, JIS 80 A, for seals up to 5 meters of capillary and level models.  
- Faces: RF and FF;  
- Temperature Range: +10 °C to 100 °C  
+ 101 to 150 °C (by inquiry)  
- Not applicable for diaphragm thickness;  
- Not applicable for use with gaskets.
- (21) Inert Fluid: Oxygen Compatibility, safe for oxygen service.
- (22) Not applicable for saline atmosphere.
- (23) IP66/68W tested for 200 hours according to NBR 8094 / ASTM B 117 standard.
- (24) Certificate for use in Hazardous Locations (CEPEL, CSA).
- (25) Not available for slip-on flange.
- (26) Diaphragms of Titanium and Monel available only in 0.1 mm, and diaphragms of Tantalum only in 0.075 mm.
- (27) Certificate for use in Hazardous Locations (CEPEL, NEPSI, NEMKO, EXAM, FM, CSA).
- (28) Certificate for use in Hazardous Locations (CEPEL, NEPSI, NEMKO, EXAM).
- (29) IPX8 tested in 10 meters of water column for 24 hours.
- (30) Ingress Protection:

Product	CEPEL	NEMKO/EXAM	FM	CSA	NEPSI
LD300	IP66/68W	IP66/68W	Type4X/6(6P)	Type4X	IP67

- (31) Not available for integral flange.

MODEL	SANITARY PRESSURE TRANSMITTERS											
LD301	4-20 mA + HART®											
CODE	Range Limits		Min. Span	Unit	Range Limits		Min. Span	Unit				
	Min.	Max.			Min.	Max.						
S2	-50	50	1.25	kPa	-200	200	0.42	inH <sub>2</sub> O	<b>Note:</b> The range can be extended up to 0.75 LRL and 1.2 URL with small degradation of accuracy. The upper range value must be limited to the connection.			
S3	-250	250	2.08	kPa	-14.7	36	2.08	psi				
S4	-2500	2500	20.83	kPa	-14.7	360	20.83	psi				
S5	-25000	25000	208.30	kPa	-14.7	3600	0.21	psi				
CODE Diaphragm Material and Fill Fluid ( Low Side)												
1	316L SST	Silicone Oil (2)	7	Tantalum	Silicone Oil (2)	E	Hastelloy C276	Inert Krytox Oil (1) (19)	Q	316L SST	Inert Haloc 4.2 Oil (19)	
2	316L SST	Inert Fluorolube Oil (3) (19)	8	Tantalum	Inert Fluorolube Oil (3) (19)	G	Tantalum	Inert Krytox Oil (19)	R	Hastelloy C276	Inert Haloc 4.2 Oil (1) (19)	
3	Hastelloy C276	Silicone Oil (1) (2)	9	316L SST	Fomblin Oil	K	Monel 400	Inert Krytox Oil (1) (19)	S	Tantalum	Inert Haloc 4.2 Oil (19)	
4	Hastelloy C276	Inert Fluorolube Oil (1) (3) (19)	A	Monel 400	Fomblin Oil (1)	M	Monel 400 Gold Plated	Silicone Oil (1) (2)				
5	Monel 400	Silicone Oil (1) (2)	D	316L SST	Inert Krytox Oil (19)	P	Monel 400 Gold Plated	Inert Krytox Oil (1) (19)				
CODE Flange(s), Adapter (s) and Drain Valve(s) Material (Low Side)												
C	Plated CS (Drain in Stainless Steel) (17)					M	Monel 400 (1)					
H	Hastelloy C276 (CW-12MW, ASTM - A494) (1)					N	316 SST - CF8M (ASTM - A351) (Drain in Hastelloy C276) (1)					
I	316 SST - CF8M (ASTM - A351)					P	316 SST - CF8M (ASTM - A351) Flange with PVDF (Kynar) insert (3) (4) (5)					
CODE Wetted O-Ring Material (Low Side)												
0	Without O-Ring		E	Ethylene - Propylene		T	Teflon				<b>Note:</b> O-Rings are not available on the sides with remote seal.	
B	Buna-N		K	Kalrez		V	Viton					
CODE Drain Position (Low Side)												
0	Without Drain					D	Bottom					<b>Note:</b> For better drain operation, drain valves are strongly recommended. Drain valve are not available on the sides with remote seal.
A	Drain (Opposite to process connection)					U	Top					
CODE Local Indicator												
0	Without Indicator					1	With Digital Indicator					
CODE Process Connection (Low Side)												
0	1/4 - 18 NPT (Without Adapter)					T	1/2-14 BSP (With Adapter)					
1	1/2 - 14 NPT (With Adapter)					U	Low Volume Flange For Level Welded					
3	Remote Seal (With Plug - Vacuum Assembly) (7)					V	Without Connection (Mounting With Gage Flange)					
5	1/2 - 14 NPT Axial with PVDF insert (3) (4) (6)					W	Without Connection (Absolut Reference)					
9	Remote Seal (Low Volume Flange) (3) (7)											
CODE Electrical Connection												
0	1/2 - 14 NPT (20)					A	M20 X 1.5 (22)					
1	3/4 - 14 NPT (With 316 SST adapter for 1/2 - 14 NPT) (21)					B	PG 13.5 DIN (22)					
2	3/4 - 14 BSP (With 316 SST adapter for 1/2 - 14 NPT) (9)					Z	User's Specification					
3	1/2 - 14 BSP (With 316 SST adapter for 1/2 - 14 NPT) (9)											
CODE Zero and Span Adjust												
1	With Local Adjustment											
CODE Process Connection												
8	Threaded DN25 DIN 11851 - with extension / 316L SST (10) (11)					7	Threaded SMS 2" - with extension / 316L SST (10) (11)					
9	Threaded DN40 DIN 11851 - with extension / 316L SST (10) (11)					E	Threaded SMS 2" - without extension / 316L SST (10) (11)					
H	Threaded DN40 DIN 11851 - without extension / 316L SST (10)					M	Threaded SMS 3" - with extension / 316L SST (10) (11)					
V	Threaded DN50 DIN 11851 - with extension / 316L SST (10) (11)					1	Threaded SMS 3" - without extension / 316L SST (10) (11)					
U	Threaded DN50 DIN 11851 - without extension / 316L SST (10)					F	Tri-Clamp 1 1/2" - without extension / 316L SST (11)					
X	Threaded DN80 DIN 11851 - with extension / 316L SST (10) (11)					Q	Tri-Clamp 1 1/2" HP (High Pressure) - without extension / 316L SST (8) (11)					
W	Threaded DN80 DIN 11851 - without extension / 316L SST (10)					6	Tri-Clamp 2" - with extension / 316L SST (11)					
4	Threaded IDF 2" - with extension / 316L SST (10) (11)					D	Tri-Clamp 2" - without extension / 316L SST (11)					
B	Threaded IDF 2" - without extension / 316L SST (10) (11)					N	Tri-Clamp 2" HP (High Pressure) - with extension / 316L SST (8) (11)					
K	Threaded IDF 3" - with extension / 316L SST (10) (11)					P	Tri-Clamp 2" HP (High Pressure) - without extension / 316L SST (8) (11)					
3	Threaded IDF 3" - without extension / 316L SST (10) (11)					I	Tri-Clamp 3" - with extension / 316L SST (11)					
5	Threaded RJT 2" - with extension / 316L SST (10) (11)					G	Tri-Clamp 3" - without extension / 316L SST (11)					
C	Threaded RJT 2" - without extension / 316L SST (10)					J	Tri-Clamp 3" HP (High Pressure) - with extension / 316L SST (8) (11)					
L	Threaded RJT 3" - with extension / 316L SST (10) (11)					R	Tri-Clamp 3" HP (High Pressure) - without extension / 316L SST (8) (11)					
2	Threaded RTJ 3" - without extension / 316L SST (10)					Z	User's specification					
S	Threaded SMS 1 1/2" - without extension / 316L SST (10) (11)											
CODE Diaphragm Material												
H	Hastelloy C276					I	316L SST					
CODE Fill Fluid												
S	DC 200 - Silicone Oil					T	Syltherm 800					
D	DC 704 - Silicone Oil					N	Neobee M20 (11)					
F	Fluorolube MO-10					G	Glycerin + Water (12)					
						B	Fomblin 06/06					
						K	Krytox 1506					
						H	Halocarbom 4.2					
CODE Wet O-ring												
0	Without O-ring		T	Teflon (11)		B	Buna-N (11)		V	Viton (11)		
CODE Tank Adapter												
0	Without Tank Adapter					1	With Tank Adapter in 316 SST					
CODE Tri-Clamp												
0	Without Tri-Clamp											
2	With Tri-Clamp in 304 SST											

LD301 S2 1 I B U 1 0 0 1 A I S T 1 2 \*

← TYPICAL MODEL NUMBER

LD301	SANITARY PRESSURE TRANSMITTER (CONTINUATION)										
CODE		Flange Bolts and Nuts Material									
A0	Plated Carbon Steel (Default) (17)				A2	Carbon Steel (ASTM A193 B7M) (1) (17)					
A1	316 SST				A5	Hastelloy C276					
CODE		Flange Thread for fixing accessories (adapters, manifolds, mounting brackets, etc)									
D0	7/16" UNF (Default)				D2	M12 X 1.75					
D1	M10 X 1.5 Thread										
CODE		Output Signal									
G0	4 – 20 mA (Default)				G3	NAMUR NE43 extended 4-20 mA (Burnout 3.55 and 22.8 mA)					
G1	0 – 20 mA (4 wire) (13)										
CODE		Housing Material (23) (24)									
H0	Aluminum (Default) (IP/TYPE)				H3	316 SST for Saline Atmosphere (IPW/TYPEX) (18)					
H1	316 SST – CF8M (ASTM – A351) (IP/TYPE)				H4	Copper Free Aluminium (IPW/TYPEX) (18)					
H2	Aluminum for Saline Atmosphere (IPW/TYPEX) (18)										
CODE		Tag Plate									
J0	With tag, when specified (Default)				J1	Blank			J2	User's Specification	
CODE		PID Configuration									
M0	With PID (Default)				M1	Without PID					
CODE		LCD1 Indication									
Y0	LCD1: Percentage (Default)				Y3	LCD1: Temperature (Engineering Unit)					
Y1	LCD1: Current - mA				YU	LCD1: User's Specification (14)					
Y2	LCD1: Pressure (Engineering Unit)										
CODE		LCD2 Indication									
Y0	LCD2: Percentage (Default)				Y6	LCD2: Temperature (Engineering Unit)					
Y4	LCD2: Current - mA				YU	LCD2: User's Specification (14)					
Y5	LCD2: Pressure (Engineering Unit)										
CODE		Identification Plate									
I1	FM: XP, IS, NI, DI				I6	Without Certification					
I2	NEMKO: Ex-d, Ex-ia				I7	EXAM (DMT): Class I, M1 Ex-ia					
I3	CSA: XP, IS, NI, DI				I8	0 to 20 mA: LD301 (13)					
I4	EXAM (DMT): Ex-ia				IF	CEPEL: Ex-d					
I5	CEPEL: Ex-d, Ex-ia										
CODE		Painting									
P0	Gray Munsell N 6.5 Polyester				P8	Without Painting					
P3	Black Polyester				P9	Safety Blue Epoxy – Electrostatic Painting					
P4	White Epoxy				PC	Safety Polyester - Electrostatic Painting					
P5	Yellow Polyester										

LD301-S211- BU10-01A2- IST12	A0	D0	G0	H0	J0	M0	Y0	Y0	I6	P0	*
------------------------------------	----	----	----	----	----	----	----	----	----	----	---

← TYPICAL MODEL NUMBER

## Optional Items

\* Leave it blank when there are not optional items.

<b>Burn-out</b>	BD - Down Scale (Accordance to NAMUR NE43 specification) BU - Up Scale (Accordance to NAMUR NE43 specification)
<b>Special Procedures</b>	C1 - Degrease Cleaning (Oxygen or Chlorine Service) (15) C2 - For Vacuum Application C4 - Polishing of the wet parts according to 3A Certification (11) (12)
<b>Special Features</b>	ZZ - User's Specification
<b>Diaphragm Thickness</b>	N0 – Default                      N1 - 0.1mm (12)

<b>Note</b>													
<p>(1) Meets NACE MR-01-75/ISO 15156 recommendations.</p> <p>(2) Silicone oil not recommended for Oxygen (O2) or Chlorine Service.</p> <p>(3) Not applicable for vacuum service.</p> <p>(4) Drain not applicable.</p> <p>(5) O-Ring material must be of Viton or Kalrez.</p> <p>(6) Maximum pressure 24 bar.</p> <p>(7) For remote seal is only available flange in 316 Stainless Steel - CF8M (ASTM A351) (thread M12).</p> <p>(8) HP – High Pressure.</p> <p>(9) Options not certified for hazardous locations.</p> <p>(10) Not available for Tri-clamp.</p> <p>(11) Compliant with 3A-7403 standard for food and other applications where sanitary connections are required: - Neobee M2O Fill Fluid - Finishing wet Face: 0,8 µm Ra (32 µ" AA) - Wet O-Ring: Viton, Buna-N and Teflon</p> <p>(12) Item by inquiry.</p>	<p>(13) Without certification for explosion proof or intrinsically safe.</p> <p>(14) Limited values to 4 1/2 digits; limited unit to 5 characters.</p> <p>(15) Degrease cleaning is not available for Carbon Steel Flanges.</p> <p>(16) Temperature application range: -40 to 140 °C and Tables 5 and 6 – pages 6.17 and 6.18.</p> <p>(17) Not applicable for saline atmosphere.</p> <p>(18) IP66/68W was tested for 200 hours according to NBR 8094 / ASTM B 117 standard.</p> <p>(19) The inert fluid guarantees safety for Oxygen (O<sub>2</sub>) service.</p> <p>(20) Certificate for use in Hazardous Locations (CEPEL, NEPSI, NEMKO, EXAM, FM, CSA).</p> <p>(21) Certificate for use in Hazardous Locations (CEPEL, CSA).</p> <p>(22) Certificate for use in Hazardous Locations (CEPEL, NEPSI, NEMKO, EXAM).</p> <p>(23) IPX8 tested in 10 meters of water column for 24 hours.</p> <p>(24) Ingress Protection:</p> <table border="1" style="width: 100%; text-align: center;"> <thead> <tr> <th>Product</th> <th>CEPEL</th> <th>NEMKO/EXAM</th> <th>FM</th> <th>CSA</th> <th>NEPSI</th> </tr> </thead> <tbody> <tr> <td>LD300</td> <td>IP66/68W</td> <td>IP66/68W</td> <td>Type4X/6(6P)</td> <td>Type4X</td> <td>IP67</td> </tr> </tbody> </table>	Product	CEPEL	NEMKO/EXAM	FM	CSA	NEPSI	LD300	IP66/68W	IP66/68W	Type4X/6(6P)	Type4X	IP67
Product	CEPEL	NEMKO/EXAM	FM	CSA	NEPSI								
LD300	IP66/68W	IP66/68W	Type4X/6(6P)	Type4X	IP67								



## CERTIFICATIONS INFORMATION

### European Directive Information

**Authorized representative in European Community**  
Smar Gmbh-Rheingaustrasse 9-55545 Bad Kreuznach

**PED Directive (97/23/EC) – Pressure Equipment Directive**

This product is in compliance with the directive and it was designed and manufactured in accordance with sound engineering practice using several standards from ANSI, ASTM, DIN and JIS.

**EMC Directive (2004/108/EC) - Electromagnetic Compatibility**

The EMC test was performed according to IEC standard: IEC61326-1:2006, IEC61326-2-3:2006, IEC61000-6-4:2006, IEC61000-6-2:2005. For use in environment only.

Keep the shield insulated at the instrument side, connecting the other one to the ground if necessary to use shielded cable.

**ATEX Directive (94/9/EC) – Equipment and protective systems intended for use in potentially explosive atmospheres.**

This product was certified according European Standards at NEMKO and EXAM (old DMT). The certified body for manufacturing quality assessment is EXAM (number 0158).

**LVD Directive 2006/95/EC – Electrical Equipment designed for use within certain voltage limits**

According the LVD directive Annex II the equipment under ATEX “Electrical equipment for use in an explosive atmosphere” directive are excluded from scope from this directive.

The EC declarations of conformity for all applicable European directives for this product can be found at [www.smar.com](http://www.smar.com).

### Others Approvals

#### Sanitary Approval

**Certifier Body: 3A Sanitary Standards**

Model Designations: LD301 S-2” clamp; LD301 S-2” Thread IDF, RJT, SMS; SR301 A-2” Clamp; SR301 A-2” Thread IDF, RJT, SMS; SR301 S-2” Clamp; SR301 S-3” Clamp. Sensors and Sensor Fittings and Connections Used on Fluid Milk and Milk Products, Number: 74-03. (Authorization No. 873).

#### Marine Approval

**Certifier Body: German Lloyd**

Environmental Category: D, EMC2 (certificate No. 85 427 - 93 HH).

#### FMEDA Report:

**Certifier Body: EXIDA**

Failure Modes, Effects & Diagnostic Analysis (Report No. R02 / 11-19).

### Hazardous Locations Certifications

NOTE
The IP68 sealing test (immersion) was performed at 1 bar for 24 hours. For any other situation, please consult Smar.

#### North American Certifications

##### FM Approvals

**Certificate N: FM 0X3A8.AE**

Explosion proof for Class I, Division 1, Groups A, B, C, and D;

Dust-ignition proof for Class II Division 1, Groups E, F, and G and Class III Division 1; Ambient

**Certificate N: FM 3V1A6.AX**

Intrinsically Safe for use in Class I, Division 1, Groups A, B, C, and D; Class II, Division 1, Groups E, F, and G; Class III, Division 1;  
Non-incendive for Class I, Division 2, Groups A, B, C, and D  
Entity parameters:  $V_{max} = 30 \text{ Vdc}$   $I_{max} = 110 \text{ mA}$   $C_i = 8\text{nF}$   $L_i = 0.24 \text{ mH}$   
Maximum Ambient Temperature: 60 °C.  
Enclosure Type 4X/6 or Type 4/6.

**Canadian Standards Association (CSA)**

**Certificate N: CSA1111005**

Class 2258 02 Explosion Proof for Class I, Division 1, Groups B, C and D; Class II, Division 1, Groups E, F and G; Class III, Division 1; Class I, Division 2, Groups A, B, C and D; Class II, Division 2, Groups E, F and G; Class III, conduit seal not required.

Class 2258 03 Intrinsically Safe and Non-Incendive Systems for Class I, Division 1, Groups A, B, C and D; Class II, Division 1, Groups E, F and G; Class III, Division 1

• Intrinsically safe when connected through CSA Certified Diode Safety Barrier, 28 Vmax, 300 ohms min, per Smar Installation Drawing 102A-0435.

Class 2258 04 Intrinsically Safe, Entity – For Hazardous Locations for Class I, Division 1, Groups A, B, C and D; Class II, Division 1, Groups E, F and G; Class III, Division 1

• Intrinsically safe with entity parameters:  $V_{max} = 28 \text{ V}$   $I_{max} = 110 \text{ mA}$   $C_i = 5 \text{ nF}$   $L_i = 0 \text{ }\mu\text{H}$ , when connected through CSA Certified Safety Barriers as per Smar Installation Drawing 102A-0435.

Maximum Ambient Temperature: 40°C.

Enclosure Type 4X or Type 4.

**European Certifications**

**Certificate No: Nemko 03 ATEX 133X**

ATEX Intrinsically Safe Group II 1GD, Ex ia IIC T4

• Entity Parameters:  $P_i = 0.7 \text{ W}$   $U_i = 28 \text{ V}$   $I_i = 100 \text{ mA}$   $C_i = 2 \text{ nF}$   $L_i = \text{Neg}$

Maximum Ambient Temperature: 62 °C.

**Certificate No: Nemko 02ATEX035**

ATEX Flameproof Group II 2G, Ex d IIC T6

Enclosure type IP66/68 or IP66/68W.

Special conditions for safe use:

1. The transmitters are marked with three options for the indication of the protection code. The certification is valid only when the protection code is indicated, by the user, in one of the boxes following the code.

The following options apply:

- **Ex d IIC T6 ( )** with X ticked in the parenthesis:  
The Ex d IIC T6 protection according to certificate **Nemko 02ATEX035X/ 02ATEX149X** applies for the specific transmitter. Certified Ex d IIC cables entries must be used.
  - **Ex ia IIC T4 ( )** with X ticked in the parenthesis:  
The Ex ia IIC T4 protection according to certificate **Nemko 03ATEX133X** applies for the specific transmitter. Certified diode safety barriers must be used.
  - **Ex d IIC T6 / Ex ia IIC T4 ( )** with X ticked in the parenthesis:  
The transmitter has double protection. Both Ex d IIC T6 and Ex ia IIC T4 protection apply for the specific transmitter according to certificates **Nemko 02ATEX035X / 02ATEX149X** and **Nemko 03ATEX133X**. In this case the transmitter must be fitted with appropriate certified cable entries Ex d IIC and the electric circuit supplied by a certified diode safety barrier as specified for the protection Ex ia IIC T4.
2. For enclosures of the transmitters made of aluminum impact and friction hazards shall be considered when the transmitter is used in category II 1 G according to EN 50284 clause 4.3.1
  3. The diode safety barrier must have a linear resistive output characteristic.
  4. The pressure of the potentially explosive atmosphere surrounding the transmitter must be within the range 0.8 mbar to 1.1 mbar.

**Certificate No: DMT 00 ATEX E 009**

ATEX Intrinsically Safe

Group II 1/2 G, Ex ia, IIC T4/T5/T6

- Entity Parameters:  $U_i = 28 \text{ Vdc}$   $I_i = 93 \text{ mA}$   $C_i \leq 5 \text{ nF}$   $L_i = \text{neg}$

**South America Certification****INMETRO approvals****Certificate No: CEPEL-Ex-049/95**

Intrinsically safe - Ex-ia IIC T5

- Entity Parameters:  $U_i = 30 \text{ Vdc}$   $I_i = 100 \text{ mA}$   $C_i = 6,4 \text{ nF}$   $L_i = \text{neg}$   $P_i = 0,7 \text{ W}$

Ambient Temperature:  $(-20^\circ\text{C} < T_{\text{amb}} < +50^\circ\text{C})$ .

Enclosure IP66/67 ou IP66/68W.

**Certificate No: CEPEL-Ex-039/96**

Flameproof - Ex-d IIC T6

Ambient Temperature:  $(-20^\circ\text{C} < T_{\text{amb}} < +40^\circ\text{C})$ .

Enclosure IP66/67 ou IP66/68W.

**Asia Certification****Certificate No: Nepsi GYJ05602**

Intrinsically safe - Ex ia, IIC

Temperature Class:

- T4  $(-40^\circ\text{C} < T_{\text{amb}} < +85^\circ\text{C})$  @  $P_i = 700 \text{ mW}$
- T5  $(-40^\circ\text{C} < T_{\text{amb}} < +50^\circ\text{C})$  @  $P_i = 700 \text{ mW}$
- T6  $(-40^\circ\text{C} < T_{\text{amb}} < +40^\circ\text{C})$  @  $P_i = 575 \text{ mW}$
- Entity Parameters:  $U_i = 28 \text{ Vdc}$   $I_i = 93 \text{ mA}$   $C_i \leq 5 \text{ nF}$   $L_i = \text{neg}$

**Certificate No: Nepsi GYJ05601**

Explosion proof - Ex d IIC T6

Ambient Temperature:  $(-20^\circ\text{C} < T < +40^\circ\text{C})$ .**Identification Plate and Control Drawing****Identification Plate**



- Identification of Intrinsically safe and Explosion Proof for gas and steam:

FM



NEMKO and DMT

**smar** LD301 Pressure Transmitter  
BR - 14160

 II 2G Ex d IIC T6 ( ) Nemko 02 ATEX035X  
 II 1GD Ex ia IIC T4 T62°C ( ) Nemko 03 ATEX133X  
 II 2G Ex d IIC T6 / II 1GD Ex ia IIC T4 T62°C ( )  
 Only one code marked with a "X" is valid.

$U_i = 28\text{ V}$   $I_i = 100\text{ mA}$   $P_i = 0,7\text{ W}$   $C_i = 2\text{ nF}$   $L_i = 0$

0044333 - 2007 **HART**  **CE** 0470

IP66  
IP68  
10m/24h

**smar** LD301 Pressure Transmitter  
BR - 14160

 II 1/2G Ex ia IIC T4/T5/T6 DMT 00 ATEX E 009 ( )  
 $P_i = 760\text{ mW}$  ( $T_4, T_a = 75^\circ\text{C}$ )  $-40^\circ\text{C} \leq T_a \leq +85^\circ\text{C}$   
 $700\text{ mW}$  ( $T_4, T_a = 85^\circ\text{C}$ )  $U_i = 28\text{ VDC}$   $I_i = 93\text{ mA}$   
 $575\text{ mW}$  ( $T_5, T_a = 60^\circ\text{C}$ )  $L_i = \text{neg}$   $C_i \leq 5\text{ nF}$   
 $575\text{ mW}$  ( $T_6, T_a = 40^\circ\text{C}$ )

 II 2G Ex d IIC T6 Nemko 02 ATEX 035X ( )

0044333 - 2007 **HART**  **CE** 0470

IP66  
IP68  
10m/24h

CEPEL

**smar** LD301 Transmissor de Pressão  
BR - 14160

 **Segurança**  
 INMETRO OCP 0007

BR - Ex d IIC T6 CEPEL - EX - 039/96  
 BR - Ex ia IIC T5 CEPEL - EX - 049/95  
 $T_{amb} = -20^\circ\text{ a } 50^\circ\text{C}$   
 $U_i = 30\text{ V}$   $I_i = 100\text{ mA}$   $P_i = 0,7\text{ W}$   
 $C_i = 6,4\text{ nF}$   $L_i = \text{desp}$

0044333 - 2007 **HART**  **CE**

IP  
66  
68

NEPSI

**smar** LD301 Pressure Transmitter  
BR - 14160

 NEPSI GYJ05601 Ex d IIC T6  
 NEPSI GYJ05602 Ex ia IIC T4/T5/T6  
 $U_i = 28\text{ V}$   $I_i = 93\text{ mA}$   $L_i = \text{neg}$   
 $P_i = 700\text{ mW}$  ( $T_4, T_a = 85^\circ\text{C}$ )  
 $575\text{ mW}$  ( $T_5, T_a = 60^\circ\text{C}$ )  
 $575\text{ mW}$  ( $T_6, T_a = 40^\circ\text{C}$ )

0044333 - 2007 **HART**  **CE**

IP  
66  
67

WITHOUT APPROVAL



- Identification of Intrinsically safe and Explosion Proof for saline atmospheres:

FM

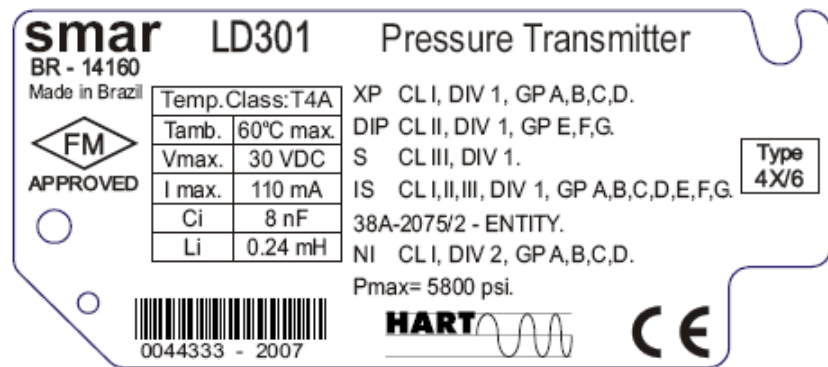

CSA



NEMKO and DMT

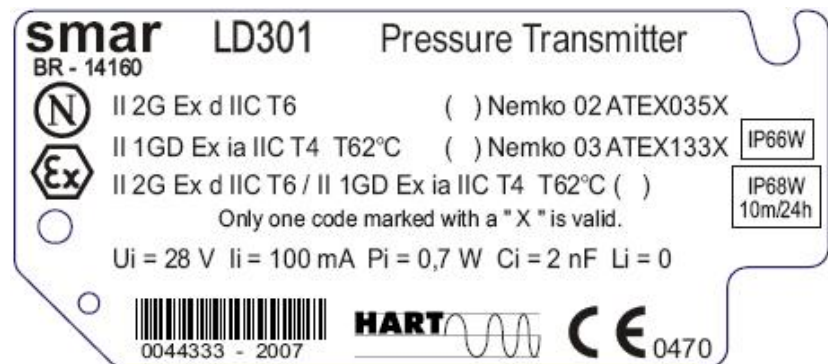

**smar** LD301 Pressure Transmitter  
BR - 14160

II 1/2G Ex ia IIC T4/T5/T6 DMT 00 ATEX E 009 ( )  
-40°C ≤ Ta ≤ +85°C  
Pi = 760 mW (T4, Ta = 75°C)  
700 mW (T4, Ta = 85°C)  
575 mW (T5, Ta = 60°C)  
575 mW (T6, Ta = 40°C)

Ui = 28 VDC li = 93 mA  
Li = neg Ci ≤ 5 nF

II 2G Ex d IIC T6 Nemko 02 ATEX 035X ( )

IP66W  
IP68W  
10m/24h

0044333 - 2007 **HART** **CE** 0470

CEPEL

**smar** LD301 Transmissor de Pressão  
BR - 14160

Segurança  
INMETRO OCP 0007

BR - Ex d IIC T6 CEPEL - EX - 039/96  
BR - Ex ia IIC T5 CEPEL - EX - 049/95  
Tamb = -20° a 50°C  
Ui = 30 V li = 100 mA Pi = 0,7 W  
Ci = 6,4 nF Li = desp

IP  
66W  
68W

0044333 - 2007 **HART** **CE**

# Control Drawing

FM

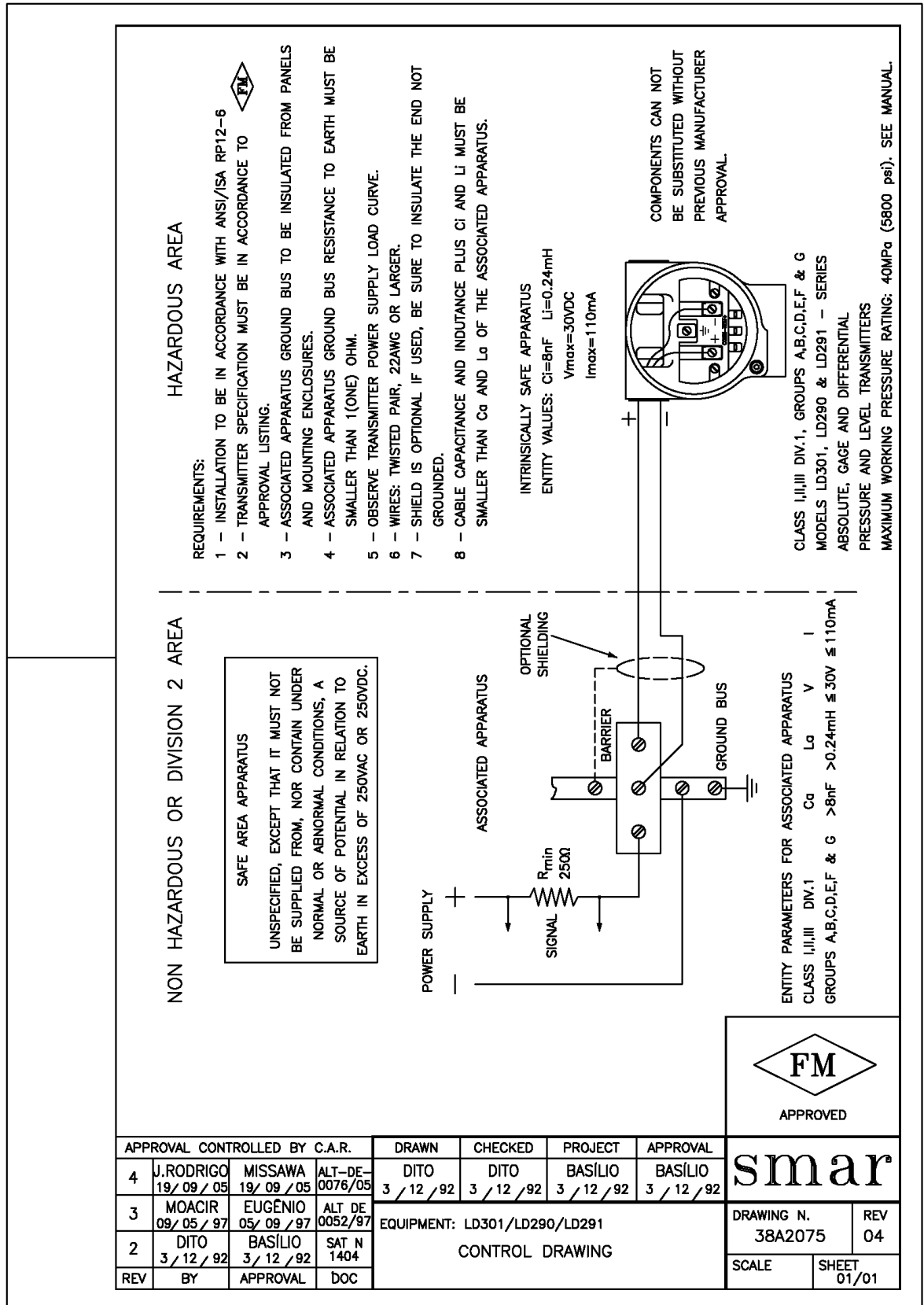

**NON HAZARDOUS OR DIVISION 2 AREA**

SAFE AREA APPARATUS

UNSPECIFIED, EXCEPT THAT IT MUST NOT BE SUPPLIED FROM, NOR CONTAIN UNDER NORMAL OR ABNORMAL CONDITIONS, A SOURCE OF POTENTIAL IN RELATION TO EARTH IN EXCESS OF 250VAC OR 250VDC.

ENTITY PARAMETERS FOR ASSOCIATED APPARATUS  
 $C_0 \geq$  CABLE CAPACITANCE +CI  
 $L_0 \geq$  CABLE INDUCTANCE +LI  
 $V_{oc} \leq 28V$   
 $I_{sc} \leq 110mA$

**HAZARDOUS AREA**

REQUIREMENTS:

- 1 – INSTALLATION TO BE IN ACCORDANCE WITH THE CEC PART I.
- 2 – ASSOCIATED APPARATUS GROUND BUS TO BE INSULATED FROM PANELS AND MOUNTING ENCLOSURES.
- 3 – ASSOCIATED APPARATUS GROUND BUS RESISTANCE TO EARTH MUST BE SMALLER THAN 1(ONE) OHM.
- 4 – OBSERVE TRANSMITTER POWER SUPPLY LOAD CURVE.
- 5 – WIRES: TWISTED PAIR, 22AWG OR LARGER.
- 6 – SHIELD IS OPTIONAL IF USED, BE SURE TO INSULATE THE END NOT GROUNDED.
- 7 – BARRIERS MUST BE "CSA" CERTIFIED AND MUST BE INSTALLED IN ACCORDANCE WITH MANUFACTURES INSTRUCTIONS.
- 8 – IF BARRIERS WITH VOLT/OHM PARAMETERS ARE USED, THE FOLLOWING PARAMETERS SHALL APPLY:-- ONE 28 V(MAX), 300 OHM(MIN).
- 9 – INTRINSICALLY SAFE, Exia FOR USE IN CLASS I, DIV. 1, GROUPS A, B, C, D;  
 CLASS II, DIV. 1, GROUPS E, F, G;  
 CLASS III, DIV. 1, WITH ENTITY INPUT PARAMETERS AS LISTED BELOW.
- 10 – NON-INCENDIVE FOR CLASS I, DIV. 2, GROUPS A, B, C, D, WITH NON-INCENDIVE FIELD WIRING INPUT PARAMETERS AS LISTED BELOW.

INTRINSICALLY SAFE APPARATUS AND NON-INCENDIVE APPARATUS ENTITY VALUES:  $C_i = 5nF$   $L_i = 0$   $V_{max} = 28VDC$   $I_{max} = 110mA$

CAUTION: EXPLOSION HAZARD – SUBSTITUTION OF COMPONENTS MAY IMPAIR SUITABILITY FOR USE IN HAZARDOUS LOCATIONS.

CAUTION: EXPLOSION HAZARD – DO NOT DISCONNECT FOR CLASS I, DIV. 2 EQUIPMENT THAT IS NOT CONNECTED TO BARRIERS.

MODELS LD290, LD291 & LD301 – SERIES  
 ABSOLUTE, GAGE AND DIFFERENTIAL  
 PRESSURE AND LEVEL TRANSMITTERS.

APPROVAL CONTROLLED BY C.A.R.				DRAWN	CHECKED	PROJECT	APPROVAL	smar	
				MOACIR 24 / 11 / 97	SINASTRE 24 / 11 / 97	BASILIO 24 / 11 / 97	EUGENIO 24 / 11 / 97		
02	MARCIAL 25 / 09 / 08	MISSAWA 25 / 09 / 08	ALT-DE 0043/08	EQUIPMENT: LD290/LD291/LD301 – CONTROL DRAWING				NUMBER 102A0435	REV 02
01	MOACIR 26 / 02 / 99	EUGENIO 26 / 02 / 99	ALT-DE 0012/99	FOR NON-INCENDIVE: CLASS I, DIV. 2				SCALE	SHEET 01/01
REV	BY	APPROVAL	doc	FOR INTRINSICALLY SAFE: CLASS I, DIV. 1					



NEMKO

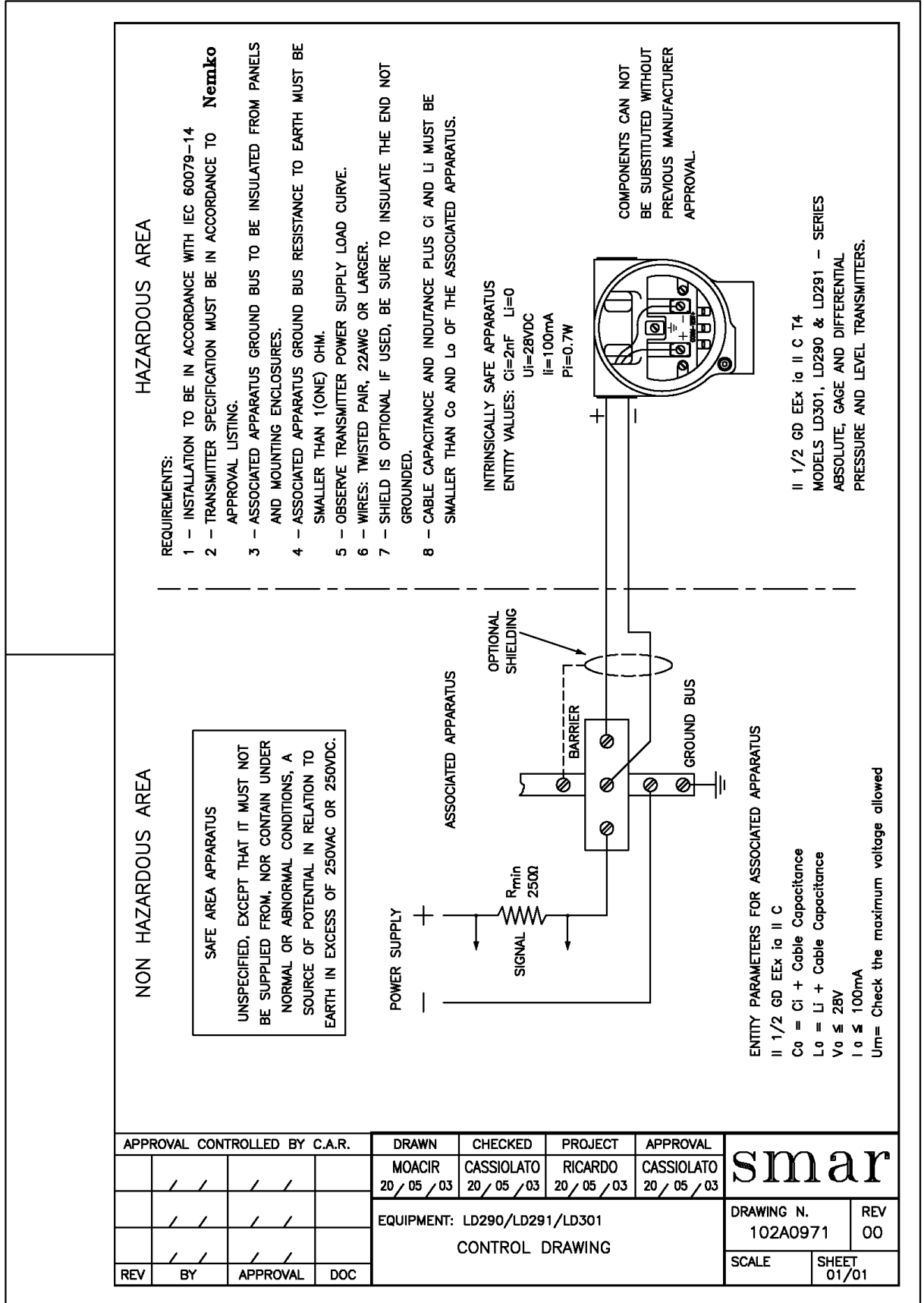



# Appendix B

		<b>SRF – Service Request Form Pressure Transmitters</b>		Proposal No.: (1)	
Company:			Unit:		Invoice:
<b>COMMERCIAL CONTACT</b>			<b>CUSTOMER CONTACT</b>		
Full Name:			Full Name:		
Function:			Function:		
Phone:		Extension:		Phone:	
Fax:		Extension:		Fax:	
Email:			Email:		
<b>EQUIPMENT DATA</b>					
Model:		Serial Number:		Sensor Number:	
Technology: ( ) 4-20 mA ( ) HART® ( ) HART® SIS ( ) WIRELESS HART® ( ) ISP ( ) FOUNDATION fieldbus™ ( ) PROFIBUS PA					Firmware Version:
<b>PROCESS DATA</b>					
Process Fluid:					
Calibration Range (4)		Ambient Temperature ( °F )		Process Temperature ( °F )	
Min.:	Max.:	Min.:	Max.:	Min.:	Max.:
Process Pressure (4)		Static Pressure (4)		Vacuum (4)	
Min.:	Max.:	Min.:	Max.:	Min.:	Max.:
				Application (3) ( ) Transmitter ( ) Repeater	
Normal Operation Time:			Failure Date:		
<b>FAILURE DESCRIPTION</b> (Please, describe the observed behavior, if it is repetitive, how it reproduces, etc.)					
Did device detect the fail? (2) ( ) Yes ( ) No		What is the final value of the current? (2) _____ mA		What is the message in the display? (2)	
<b>MAINTENANCE INFORMATION</b>					
Did you allow the upgrade in the firmware? ( ) Yes ( ) No			Certification plate: Will it maintained the certification? ( ) Yes ( ) No		
Main board configuration: ( ) Original factory configuration ( ) Default configuration ( ) Special configuration (should be informed by the client. Please, use the space below)					
<b>OBSERVATIONS</b>					
<b>SUBMITTER INFORMATION</b>					
Company:					
Submitted by:		Title:		Section:	
Phone:		Extension:		E-mail:	
Date:		Signature:			
For warranty or non-warranty repair, please contact your representative. Further information about address and contacts can be found on <a href="http://www.smar.com/contactus.asp">www.smar.com/contactus.asp</a> .					
<b>NOTE</b>					
(1) This field should be filled out by the Smar.		(3) Required for Wireless HART® devices.			
(2) Required for SIS devices.		(4) Required to specify the pressure unit.			



## SMAR WARRANTY CERTIFICATE

1. SMAR guarantees the equipment of its own manufacture for a period of 24 (twenty four) months, starting on the day the invoice is issued. The guarantee is effective regardless of the day the product was installed. Third-party equipment and software are not included in this Term of Guarantee and Smar does not offer any guarantee or declaration in the name of the manufacturer. Any guarantees related to these products are the supplier or licensor responsibility.
2. SMAR products are guaranteed against any defect originating from manufacturing, mounting, whether of a material or manpower nature, provided that the technical analysis reveals the existence of a quality failure liable to be classified under the meaning of the word, duly verified by the technical team within the warranty terms.
3. Exceptions are proven cases of inappropriate use, wrong handling or lack of basic maintenance compliant to the equipment manual provisions. SMAR does not guarantee any defect or damage caused by an uncontrolled situation, including but not limited to negligence, user imprudence or negligence, natural forces, wars or civil unrest, accidents, inadequate transportation or packaging due to the user's responsibility, defects caused by fire, theft or stray shipment, improper electric voltage or power source connection, electric surges, violations, modifications not described on the instructions manual, and/or if the serial number was altered or removed, substitution of parts, adjustments or repairs carried out by non-authorized personnel; inappropriate product use and/or application that cause corrosion, risks or deformation on the product, damages on parts or components, inadequate cleaning with incompatible chemical products, solvent and abrasive products incompatible with construction materials, chemical or electrolytic influences, parts and components susceptible to decay from regular use, use of equipment beyond operational limits (temperature, humidity, etc.) according to the instructions manual. In addition, this Warranty Certificate excludes expenses with transportation, freight, insurance, all of which are the customer's responsibility.
4. For warranty or non-warranty repair, please contact your representative.

Further information about address and contacts can be found on [www.smar.com/contactus.asp](http://www.smar.com/contactus.asp)

5. In cases needing technical assistance at the customer's facilities during the warranty period, the hours effectively worked will not be billed, although SMAR shall be reimbursed from the service technician's transportation, meals and lodging expenses, as well dismounting/mounting costs, if any.
6. The repair and/or substitution of defective parts do not extend, under any circumstance, the original warranty term, unless this extension is granted and communicated in writing by SMAR.
7. No Collaborator, Representative or any third party has the right, on SMAR's behalf, to grant warranty or assume some responsibility for SMAR products. If any warranty would be granted or assumed without SMAR's written consent, it will be declared void beforehand.
8. Cases of Extended Warranty acquisition must be negotiated with and documented by SMAR.
9. If necessary to return the equipment or product for repair or analysis, contact us.  
See item 4.
10. In cases of repair or analysis, the customer must fill out the Revision Requisition Form (FSR) included in the instructions manual, which contains details on the failure observed on the field, the circumstances it occurred, in addition to information on the installation site and process conditions. Equipments and products excluded from the warranty clauses must be approved by the client prior to the service execution.
11. In cases of repairs, the client shall be responsible for the proper product packaging and SMAR will not cover any damage occurred in shipment.

12. In cases of repairs under warranty, recall or outside warranty, the client is responsible for the correct packaging and packing and SMAR shall not cover any damage caused during transportation. Service expenses or any costs related to installing and uninstalling the product are the client's sole responsibility and SMAR does not assume any accountability before the buyer.
13. It is the customer's responsibility to clean and decontaminate products and accessories prior to shipping them for repair, and SMAR and its dealer reserve themselves the right to refuse the service in cases not compliant to those conditions. It is the customer's responsibility to tell SMAR and its dealer when the product was utilized in applications that contaminate the equipment with harmful products during its handling and repair. Any other damages, consequences, indemnity claims, expenses and other costs caused by the lack of decontamination will be attributed to the client. Kindly, fill out the Declaration of Decontamination prior to shipping products to SMAR or its dealers, which can be accessed at [www.smar.com/doc/declarationofcontamination.pdf](http://www.smar.com/doc/declarationofcontamination.pdf) and include in the packaging.
14. This warranty certificate is valid only when accompanying the purchase invoice.